

TPSM82480 5.5-V Input, 6-A, Step-Down Converter Module with Integrated Inductor

1 Features

- Ultra small 3.6 × 7.9 × 1.55 mm power module
- CISPR11 Class B compliant
- Feedback voltage accuracy: ±1%
- Input voltage range: 2.4 V to 5.5 V
- Output voltage range: 0.6 V to 5.5 V
- Output current: 6-A with no derating at $T_A = 85\text{ }^\circ\text{C}$
- Typical quiescent current: 23 μA
- Output voltage select (two user-defined values)
- Phase-shifted operation
- Automatic power save mode or forced PWM option
- Adjustable soft-start and tracking
- Power good and thermal good outputs
- Undervoltage lockout protection
- Overcurrent and short-circuit protection
- Over-temperature protection
- Operating temperature range: $-40\text{ }^\circ\text{C}$ to $125\text{ }^\circ\text{C}$

2 Applications

- Low profile point-of-load supply
- [Aerospace and defense](#)
- [Factory automation and control](#)
- [Optical modules](#)
- [Professional audio, video and signage](#)

3 Description

The TPSM82480 is a synchronous step-down DC-DC converter module for low profile point-of-load power supplies. The input voltage range of 2.4 V to 5.5 V enables operation from typical 3.3-V or 5-V interface supplies as well as from backup circuits dropping down as low as 2.4 V.

The output current is up to 6 A continuously provided by two phases of 3 A each, which run out-of-phase, reducing pulse current noise significantly.

The TPSM82480 provides an automatically entered power save mode to maintain high efficiency down to very light loads. This incorporates an automatic phase adding and shedding feature using both or only one phase according to the actual load. The power save mode can be switched off using the MODE feature.

The device offers a power good signal and an adjustable soft-start period. Also, the device features a thermal good signal to indicate excessive internal temperature. The output voltage can be changed to a preselected value by VSEL pin. TPSM82480 is able to operate in 100% duty cycle mode.

Device Information⁽¹⁾

PART NUMBER	PACKAGE	BODY SIZE (NOM)
TPSM82480MOP	QFM (24)	7.90 × 3.60 × 1.55 mm

(1) For all available packages, see the orderable addendum at the end of the data sheet.

Typical Application

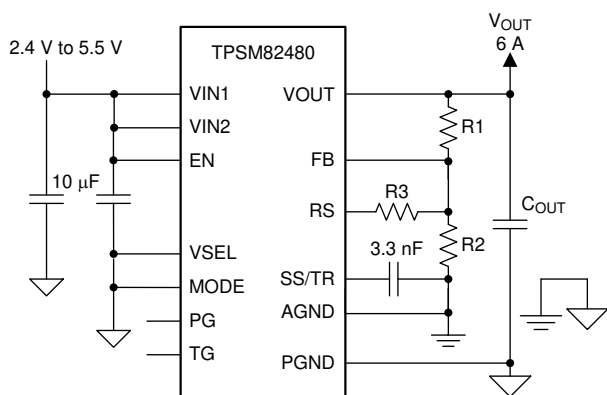

Efficiency vs Output Current

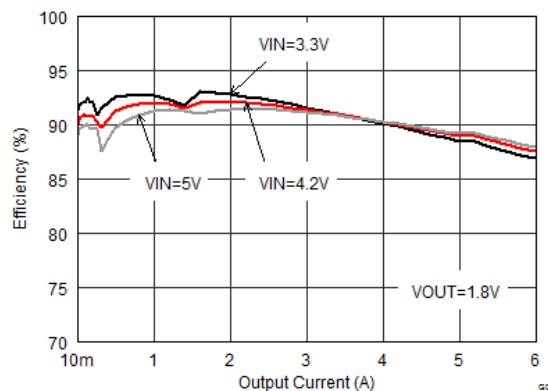

Table of Contents

1 Features	1	8 Application and Implementation	12
2 Applications	1	8.1 Application Information.....	12
3 Description	1	8.2 Typical Application	12
4 Revision History	2	8.3 System Examples	22
5 Pin Configuration and Functions	3	9 Power Supply Recommendations	22
6 Specifications	4	10 Layout	23
6.1 Absolute Maximum Ratings	4	10.1 Layout Guidelines	23
6.2 ESD Ratings	4	10.2 Layout Example	23
6.3 Recommended Operating Conditions.....	4	11 Device and Documentation Support	24
6.4 Thermal Information	4	11.1 Documentation Support	24
6.5 Electrical Characteristics.....	5	11.2 Receiving Notification of Documentation Updates	24
6.6 Typical Characteristics.....	7	11.3 Community Resources.....	24
7 Detailed Description	8	11.4 Trademarks	24
7.1 Overview	8	11.5 Electrostatic Discharge Caution.....	24
7.2 Functional Block Diagram	8	11.6 Glossary	24
7.3 Feature Description.....	9	12 Mechanical, Packaging, and Orderable Information	24
7.4 Device Functional Modes.....	10	12.1 Tape and Reel Information	25

4 Revision History

Changes from Revision B (May 2020) to Revision C	Page
• Added hyperlinks to end applications list	1
• Updated <i>Typical Application</i>	1
• Added application report references in <i>Setting V_{OUT2} Using the VSEL Feature</i>	13
• Added footnote to Table 2	14
• Added user's guide reference to <i>Layout Guidelines</i> section	23

Changes from Revision A (March 2018) to Revision B	Page
• Added EMI performance curves	18

Changes from Original (July 2017) to Revision A	Page
• Changed data sheet status from Advance Information to Production Data	1

5 Pin Configuration and Functions

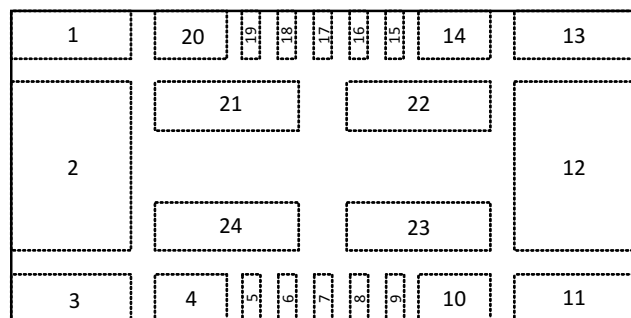
**MOP Package
24-Pin QFM**

TOPVIEW

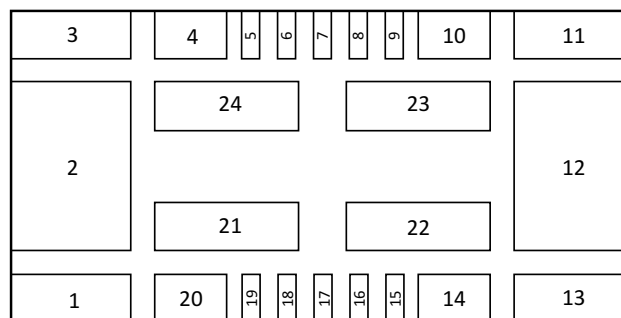

BOTTOMVIEW

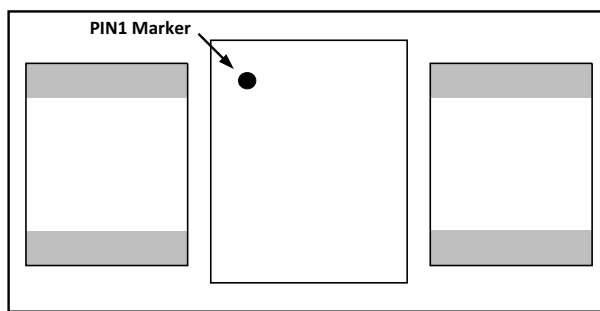

Pin Functions

PIN		I/O	DESCRIPTION
NAME	NO.		
VOUT1	1		Output voltage node phase 1 (master), must be connect with VOUT2
PGND1	2, 3, 20,21		Power ground phase 1 (master)
VIN1	4, 24		Supply voltage phase 1 (master)
EN	5	I	Enable input (high=enabled, low = disabled) do not leave floating
PG	6	O	Power good (open drain, requires pull-up resistor). Connect to GND or leave unconnected if not used.
VSEL	7	I	Output voltage select (high = VOUT2, low = VOUT1) , VOUT1 < VOUT2
TG	8	O	Thermal good (open drain, requires pull-up resistor). Connect to GND or leave unconnected if not used.
MODE	9	I	Operating mode selection (Low=Automatic PWM/PSM, high = forced PWM)
VIN2	10, 23		Supply voltage phase 2
PGND2	11,12, 14, 22		Power ground phase 2
VOUT2	13		Output voltage node phase 2, Must be connected with VOUT1
SS/TR	15		Soft-start and tracking. An external capacitor connected to this pin sets the output voltage rise time. The voltage rating of the capacitor must be larger than the input voltage.
AGND	16		Analog ground. Must be externally connected to PGND.
FB	17		Output voltage feedback. Connect resistive voltage divider to this pin.
RS	18	O	Resistor select. Connect resistor that sets the level for the second output voltage here (activated by VSEL= high). Connect to GND or leave unconnected if not used.
VO	19		VOUT detection (connect to VOUT, output discharge is internally connected to this pin)

6 Specifications

6.1 Absolute Maximum Ratings

		MIN	MAX	UNIT
Pin Voltage Range ⁽¹⁾	VIN	-0.3	6	V
	EN, VSEL, MODE, SS/TR, PG, TG	-0.3	6	V
	FB, RS	-0.3	3	V
Power Good / Thermal Good Sink Current	PG, TG		10	mA
Operating Junction Temperature Range, T _J		-40	150	°C
Storage Temperature Range, T _{stg}		-65	150	°C

(1) All voltages are with respect to network ground terminal.

6.2 ESD Ratings

			VALUE	UNIT
V _(ESD)	Electrostatic discharge	Human body model (HBM), per ANSI/ESDA/JEDEC JS-001, all pins ⁽¹⁾	±1000	V
		Charged device model (CDM), per JEDEC specification JESD22-C101, all pins ⁽²⁾	±500	

(1) JEDEC document JEP155 states that 500-V HBM allows safe manufacturing with a standard ESD control process.

(2) JEDEC document JEP157 states that 250-V CDM allows safe manufacturing with a standard ESD control process.

6.3 Recommended Operating Conditions

	MIN	TYP	MAX	UNIT
Supply Voltage Range, V _{IN}	2.4		5.5	V
Output Voltage Range, V _{OUT}	0.6		5.5	V
Maximum Output Current, I _{OUT}	6			A
Operating junction temperature, T _J	-40		125	°C

6.4 Thermal Information

THERMAL METRIC ⁽¹⁾		TPSM82480	UNIT
		MOP 24 PINS	
		JEDEC 51-5 with thermal vias	
R _{θJA}	Junction-to-ambient thermal resistance	32.2	°C/W
R _{θJC(top)}	Junction-to-case (top) thermal resistance	13.6	°C/W
R _{θJB}	Junction-to-board thermal resistance	11.5	°C/W
ψ _{JT}	Junction-to-top characterization parameter	0.53	°C/W
ψ _{JB}	Junction-to-board characterization parameter	11.3	°C/W

(1) For more information about traditional and new thermal metrics, see the *IC Package Thermal Metrics* application report, [SPRA953](#).

6.5 Electrical Characteristics

over operating junction temperature range ($T_J = -40^\circ\text{C}$ to 125°C) and $V_{IN} = 2.4\text{ V}$ to 5.5 V . Typical values at $V_{IN} = 3.6\text{ V}$ and $T_J = 25^\circ\text{C}$ (unless otherwise noted).

PARAMETER		TEST CONDITIONS	MIN	TYP	MAX	UNIT
SUPPLY						
V_{IN}	Input Voltage Range	V_{IN} rising	2.6		5.5	V
		V_{IN} falling	2.4		5.5	
I_Q	Operating Quiescent Current	EN = High, $V_{IN} \geq 3\text{ V}$, $I_{OUT} = 0\text{ mA}$, device not switching, $T_J = -40^\circ\text{C}$ to $+85^\circ\text{C}$		23	38	μA
		100% Mode operation		3.5	6.5	mA
I_{SD}	Shutdown Current	EN = Low ($\leq 0.3\text{ V}$), $T_J = -40^\circ\text{C}$ to $+85^\circ\text{C}$		0.5	18.5	μA
V_{UVLO}	Undervoltage Lockout Threshold	Falling Input Voltage	2.2	2.3	2.4	V
		Hysteresis		200		mV
T_{SD}	Thermal Shutdown Temperature	PWM Mode, Rising Junction Temperature		160		$^\circ\text{C}$
	Thermal Shutdown Hysteresis	PWM Mode		10		
CONTROL (EN, VSEL, MODE, SS/TR, PG, TG)						
V_H	Input Threshold Voltage (EN, VSEL, MODE)	to ensure High Level	1.2			V
V_L	Input Threshold Voltage (EN, VSEL, MODE)	to ensure Low Level			0.4	
$I_{LKG(EN)}$	Input Leakage Current (EN)	EN = V_{IN} or GND		10	200	nA
$I_{LKG(MODE)}$	Input Leakage Current (MODE, VSEL)			10	200	nA
$I_{SS/TR}$	SS/TR pin source current		4.7	5.25	5.8	μA
$V_{TH(TG)}$	Thermal Good Threshold Temperature	PWM Mode		120		$^\circ\text{C}$
	Thermal Good Hysteresis	PWM Mode		10		
$V_{TH(PG)}$	Power Good Threshold Voltage	Rising (% V_{OUT})	93%	96%	99%	
		Falling (% V_{OUT})	89%	92%	95%	
$V_{L(PG)}$	Output Low Threshold (PG, TG)	$I_{PG} = -2\text{ mA}$			0.4	V
$I_{LKG(PG)}$	Input Leakage Current (PG)			2	700	nA
$I_{LKG(TG)}$	Input Leakage Current (TG)			2	100	nA
t_{SS}	Internal Soft-Start Time	SS/TR = V_{IN} or floating		80		μs
t_{DELAY}	Time from EN rising until start switching		100	200	400	μs
POWER SWITCH						
$R_{DS(ON)}$	High-Side MOSFET ON-Resistance	$V_{IN} \geq 3\text{ V}$	Phase1	36	98	$\text{m}\Omega$
			Phase2			
	Low-Side MOSFET ON-Resistance		Phase1	29	72	
			Phase2			
I_{LIM}	High-Side MOSFET Current Limit	per phase	4.2	5.0	5.8	A

Electrical Characteristics (continued)

over operating junction temperature range ($T_J = -40^\circ\text{C}$ to 125°C) and $V_{IN} = 2.4\text{ V}$ to 5.5 V . Typical values at $V_{IN} = 3.6\text{ V}$ and $T_J = 25^\circ\text{C}$ (unless otherwise noted).

PARAMETER		TEST CONDITIONS		MIN	TYP	MAX	UNIT
OUTPUT							
V_{REF}	Internal Reference Voltage			0.6			V
$I_{LKG(FB)}$	Input Leakage Current (FB)	EN = High	$V_{FB} = 0.6\text{ V}$	1	65		nA
$I_{LKG(RS)}$	Input Leakage Current (RS)		VSEL = Low, $V_{RS} = 0.6\text{ V}$	1	65		nA
R_{RS}	Internal resistance (RS to GND)		VSEL = High, $I_{RS} = 1\text{ mA}$	10	50		Ω
V_{OUT}	Output Voltage Range	$V_{IN} \geq V_{OUT}$		0.6		5.5	V
V_{OUT}	Feedback Voltage Accuracy	PWM Mode, $V_{IN} \geq V_{OUT} + 1\text{ V}$	$T_J = -20^\circ\text{C}$ to 85°C	-1%		1%	
			$T_J = -40^\circ\text{C}$ to 125°C	-1.4%		1.3%	
V_{OUT}	Feedback Voltage Accuracy	Power Save Mode, $L = 0.47\text{ }\mu\text{H}$, $C_{OUT} = 4 \times 22\text{ }\mu\text{F}^{(1)}$		-1.4%		2.5%	
	Output Discharge Current ⁽²⁾	EN = Low, $V_{OUT} = 2.5\text{ V}$			120		mA
	Load Regulation	$V_{OUT} = 1.8\text{ V}$, PWM mode operation			0.02		%/A
	Line Regulation	$2.6\text{ V} \leq V_{IN} \leq 5.5\text{ V}$, $V_{OUT} = 1.8\text{ V}$, $I_{OUT} = 6\text{ A}$, PWM mode operation			0.02		%/V

- (1) The output voltage accuracy in Power Save Mode can be improved by increasing the output capacitor value, reducing the output voltage ripple.
- (2) For detailed information on output discharge see [Active Output Discharge](#).

6.6 Typical Characteristics

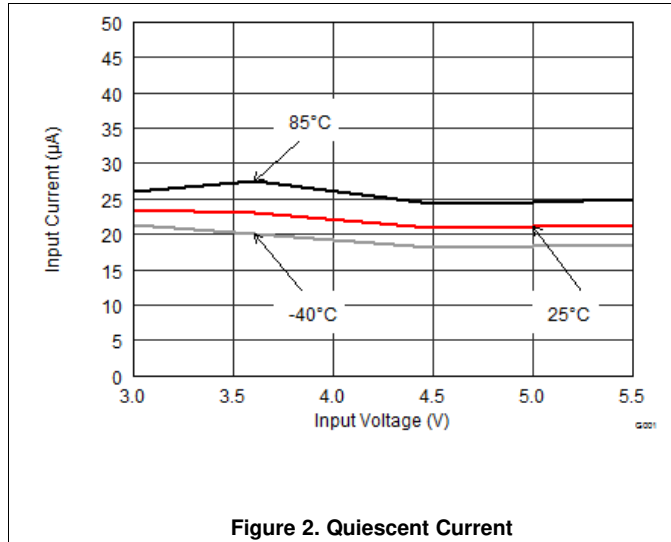

Figure 2. Quiescent Current

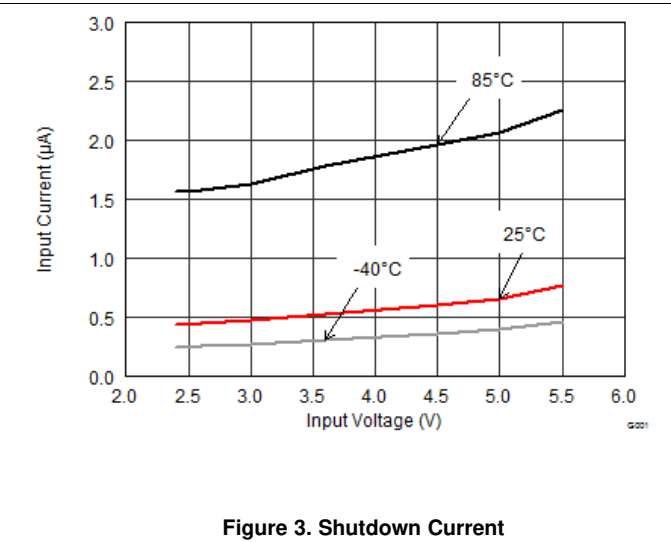

Figure 3. Shutdown Current

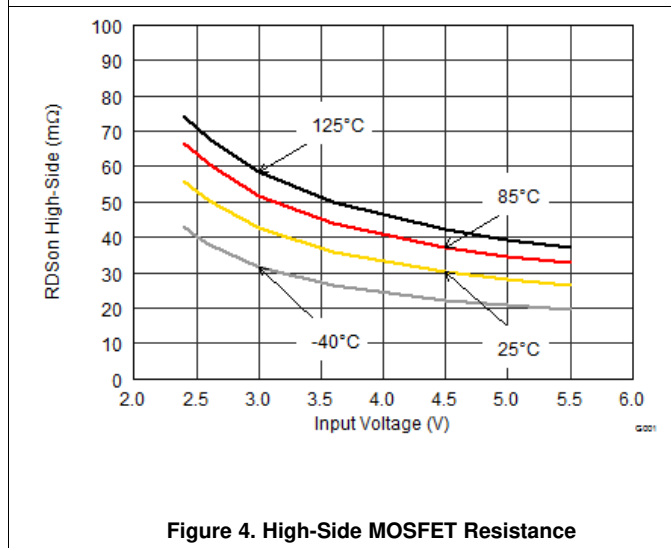

Figure 4. High-Side MOSFET Resistance

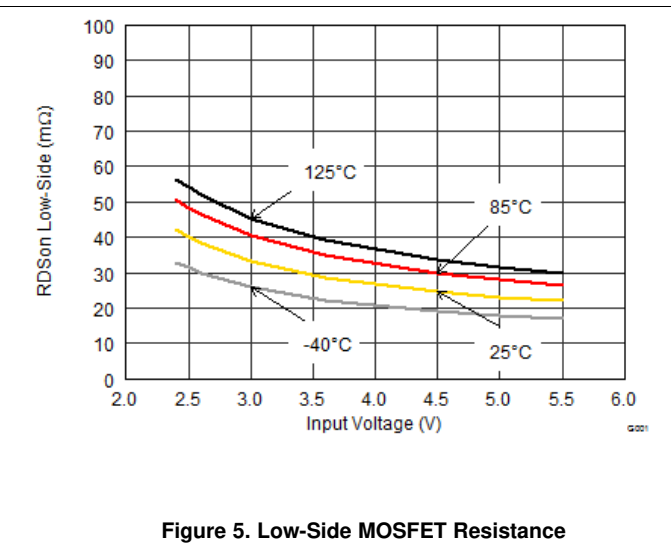

Figure 5. Low-Side MOSFET Resistance

7 Detailed Description

7.1 Overview

The TPSM82480 is a high efficiency synchronous switched mode step-down converter module based on a 2-phase peak current control topology. It is designed for smallest solution size low-profile applications, converting a 2.4 V to 5.5 V input voltage into a lower 0.6 V to 5.5 V output voltage. While an outer voltage loop sets the regulation threshold for the inner current loop, based on the actual V_{OUT} level, the inner current loop regulates to the actual peak inductor current level for every switching cycle. The regulation network is internally compensated. While the ON-time is determined by duty cycle, inductance and cycle peak current, the switching frequency of typically 2.2 MHz is set by a predicted OFF-time. The device features a Power Save Mode (PSM) to keep the conversion efficiency high over the whole load current range.

The TPSM82480 is a 2-phase converter, sharing the load among the phases. Identical in construction, the second phase control is connected with an adaptive delay to the first phase. Both the phases use the same regulation threshold and cycle-by-cycle peak current setpoint. This ensures a phase-shifted as well as current-balanced operation. Using the advantages of the 2-phase topology, a 6-A continuous output current is provided with high performance and as small as possible solution size.

7.2 Functional Block Diagram

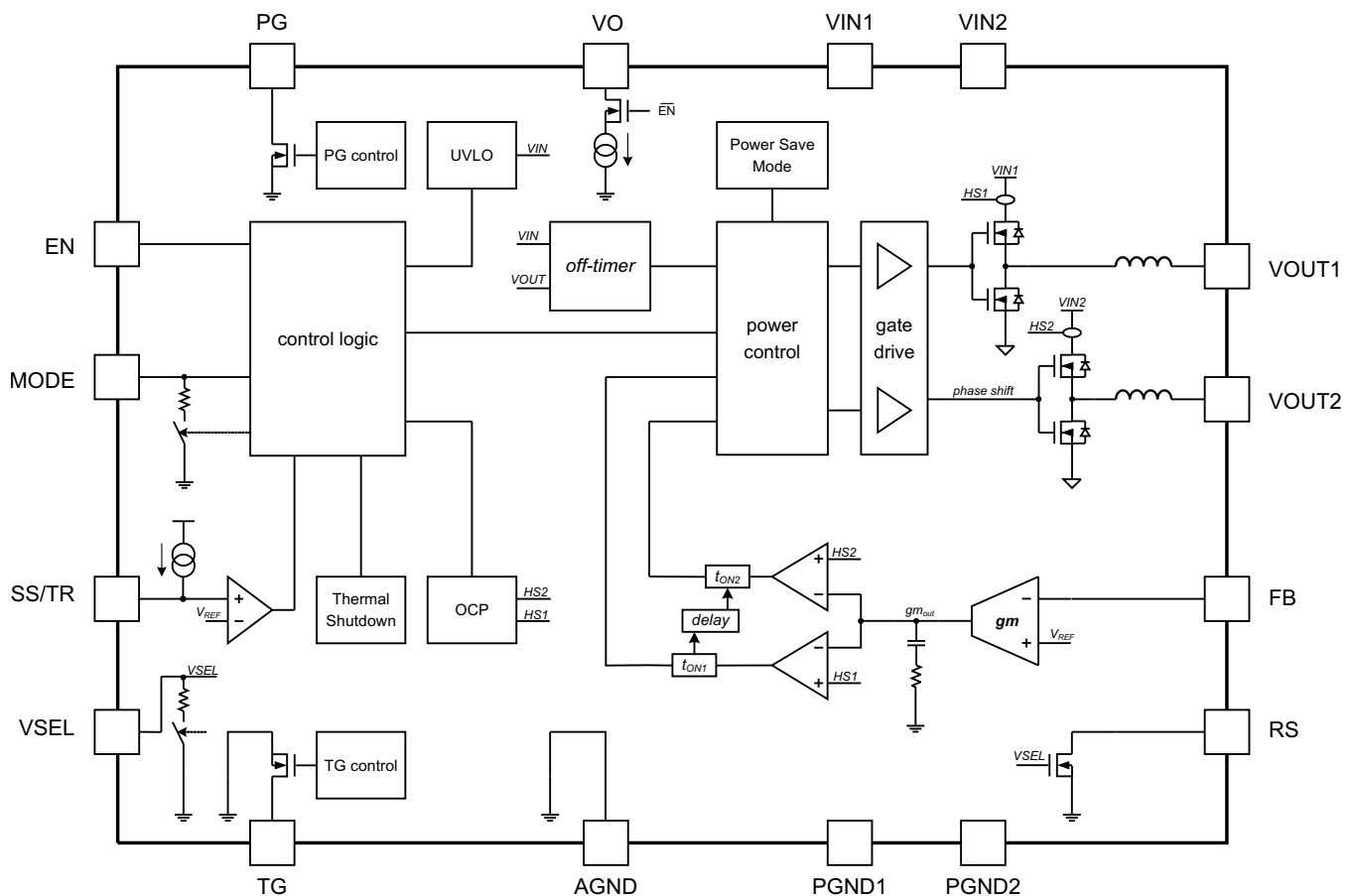

Copyright © 2017, Texas Instruments Incorporated

Figure 6. TPSM82480

7.3 Feature Description

7.3.1 Enable and Shutdown (EN)

The device starts operation, when VIN is present and enable (EN) is set High. Because the boundary EN thresholds are specified with 1.2 V for rising and 0.4 V for falling voltages, the typical values are 0.85 V (rising) and 0.65 V (falling). The device is disabled by pulling EN Low. Leaving the EN pin floating is not recommended.

7.3.2 Soft-Start (SS), Pre-biased Output

The internal soft-start circuit controls the output voltage slope during startup. This avoids excessive inrush current and provides an adjustable controlled output-voltage rise time. The soft-start period also prevents unwanted voltage drop from high impedance power sources or batteries.

When EN is set to start device operation, the device starts switching after a delay of typically 200 μ s and VOUT rises with a slope, controlled by the external capacitor which is connected to the SS/TR pin (soft start). Leaving the SS/TR pin floating or connecting to VIN provides internally set fastest startup with a soft-start slope of approximately 80 μ s. See [Application Curves](#) for typical startup operation.

The device can start into a pre-biased output. In this case, the device starts switching, only when the internal set point for VOUT increases above the pre-biased voltage level.

7.3.3 Tracking (TR)

The device tracks an external voltage applied to the SS/TR pin. The FB voltage tracks the external voltage as long as it is below approximately 0.6V. Above 0.6V the device goes to normal operation. If the voltage at the SS/TR pin decreases below approximately 0.6V, the FB voltage tracks again this voltage. See [Tracking](#) for further details.

7.3.4 Output Voltage Select (VSEL)

A resistive divider (VOUT to FB to AGND) sets the output voltage of the TPSM82480. Providing a logic High level at the VSEL pin, the RS pin is pulled to ground, so that a resistor, between FB and RS pins is connected in parallel to the lower resistor of the divider. This sets a different higher output voltage and can be used for dynamic voltage scaling (see [Setting V_{OUT2} Using the VSEL Feature](#)).

If the VSEL pin is set Low, the device connects an internal pull down resistor to the pin, keeping the internal logic level Low, even if the pin is floating afterwards. The device disconnects the resistor, if the pin is set to High.

7.3.5 Forced PWM (MODE)

To avoid [Power Save Mode \(PSM\) Operation](#), the device can be forced to PWM mode operation by pulling the MODE pin High. In this case the device operates continuously with its nominal switching frequency and the minimum peak current can go as low as -500 mA.

If the MODE pin is set Low, the device connects an internal pull down resistor to keep the internal logic level Low, even if the pin is floating afterwards. The device disconnects the resistor, if the pin is set to High.

7.3.6 Power Good (PG)

The TPSM82480 has a built in power good function. The PG pin goes High, when the output voltage has reached its nominal value. Otherwise, including when disabled, in UVLO or thermal shutdown, PG is Low. The PG pin is an open drain output that requires a pull-up resistor and can sink typically 2mA. If not used, the PG pin can be left floating or grounded.

7.3.7 Thermal Good (TG)

As long as the junction temperature of the TPSM82480 is below the thermal good temperature of typically 120°C, the logic level at the TG pin is High. If the junction temperature exceeds that temperature, the TG pin goes Low. This can be used for the system to take action preventing excessive heating or even thermal shutdown. The TG pin is an open drain output that requires a pull-up resistor and can sink typically 2mA. If not used, the TG pin can be left floating or grounded.

Feature Description (continued)

7.3.8 Active Output Discharge

The VO pin, connected to the output voltage, provides an active discharge path when the device is switched off by setting EN Low or UVLO event. In case of being activated, this discharge circuit sinks typically 120mA for output voltages of typically 1 V and above. If V_{OUT} is lower, the active current sink enters linear operation mode and the discharge current decreases.

7.3.9 Undervoltage Lockout (UVLO)

The undervoltage lockout prevents misoperation of the device, if the input voltage drops below the UVLO threshold which is set to typically 2.3 V. The converter starts operation again once the input voltage exceeds the threshold by a hysteresis of typically 200 mV.

7.3.10 Thermal Shutdown

The junction temperature (T_J) of the device is monitored by an internal temperature sensor. If T_J exceeds 160°C (typical), the device goes in thermal shutdown with a hysteresis of approximately 10°C. Both the power FETs are turned off and the PG pin goes Low. Once T_J has decreased enough, the device resumes normal operation with the soft-start sequence.

7.4 Device Functional Modes

7.4.1 Pulse Width Modulation (PWM) Operation

The TPSM82480 is based on a predictive OFF-time peak current control topology, operating with PWM in continuous conduction mode for current loads larger than half the ripple current. The switching frequency is typically 2.2MHz. Both the master and follower phase regulate to the same VOUT level, each with a separate current loop, using the same peak current set point, cycle by cycle. This provides excellent peak current balancing, independent of inductor dc resistance matching. Because the follower phase operates with an adaptive delay to the master phase, phase shifted operation is always obtained. If the load current decreases, the device runs with the master phase only (see [Phase Add/ Shed and Current Balancing](#)).

PWM only mode can be forced by pulling MODE pin High. If MODE is set Low, the device features an automatic transition into Power Save Mode, entered at light loads, running in discontinuous conduction mode (DCM).

7.4.2 Power Save Mode (PSM) Operation

As the load current decreases to half the ripple current, the converter enters Power Save Mode operation. During PSM, the converter operates with reduced switching frequency maintaining high conversion efficiency. Power Save Mode is based on an adaptive peak current target, to keep output voltage ripple low. Because each pulse shifts V_{OUT} up, a pause time happens until V_{OUT} trips the internal V_{OUT_Low} threshold again and the next pulse takes place.

The switching frequency in PSM (one phase operation) calculates as:

$$f_{SW(PSM)} = \frac{2 \cdot I_{OUT} \cdot V_{OUT} (V_{IN} - V_{OUT})}{L \cdot I_{PEAK}^2 \cdot V_{IN}} \quad (1)$$

7.4.3 Minimum Duty Cycle and 100% Mode Operation

The minimum on-time, which is typically 70ns, normally determines a limit on the minimum operating duty cycle. The calculation is:

$$DC_{min} = 70ns \cdot 100\% \cdot f_{SW} [Hz] \quad (2)$$

However, a frequency foldback lowers the switching frequency depending on the duty cycle and ensures proper regulation for every duty cycle.

Device Functional Modes (continued)

There is no limit towards maximum duty cycle. When the input voltage becomes close to the output voltage, the device enters automatically 100% duty cycle mode and both high-side FETs switch on as long as V_{OUT} remains lower than the regulation setpoint. In this case, the voltage drop across the high-side FETs and the inductors determines the output voltage level. An estimate for the minimum input voltage to maintain output voltage regulation is:

$$V_{IN(min)} = V_{OUT(min)} + I_{OUT} \times \left(\frac{(R_{DS(on)} + 20 \text{ m}\Omega)}{2} \right)$$

where

- typical DCR of each inductor is 20 mΩ
- the maximum DCR of each inductor is 27 mΩ (3)

In 100% duty cycle mode, the low-side FETs are switched off. The typical quiescent current in 100% mode is 3.5 mA.

7.4.4 Phase Shifted Operation

Using an inherent benefit of the two-phase conversion, the two phases of TPSM82480 run out of phase. For every switching cycle, the second phase is not allowed to turn on its high-side FET until the master phase has reached its peak current value. This limits the input RMS current and corresponding switching noise.

7.4.5 Phase Add/Shed and Current Balancing

When the load current is below the internal threshold, only the master phase operates. The second phase activates, if the load current exceeds the threshold of typically 1.7 A. The second phase powers off with a hysteresis of approximately 0.5 A, when the load current decreases.

7.4.6 Current Limit and Short Circuit Protection

Each phase has a separate integrated peak current limit. The dc values are specified in the [Electrical Characteristics](#). While its minimum value limits the output current of the phase, the maximum number gives the current that must be considered to flow in some operating case (e.g. overload). At the peak current limit, the device provides its maximum output current.

However, if the current limit situation remains for 512 consecutive switching cycles, the peak current folds back to approximately 1/3 of the regular limit. This limits the output power for over current and short circuit events. The foldback current limit is released to the normal one only if the load current has decreased as far as needed to undercut the (foldback) peak current limit.

8 Application and Implementation

NOTE

Information in the following applications sections is not part of the TI component specification, and TI does not warrant its accuracy or completeness. TI's customers are responsible for determining suitability of components for their purposes. Customers should validate and test their design implementation to confirm system functionality.

8.1 Application Information

The TPSM82480 is a switched mode step-down converter module, able to convert a 2.4-V to 5.5-V input voltage into a lower 0.6-V to 5.5-V output voltage, providing up to 6 A continuous output current. It needs a minimum amount of external components. Apart from the output and input capacitors, additional resistors or capacitors are only needed to enable features such as soft-start timing, adjustable and selectable output voltage as well as power good and/or thermal good confirmation. The required power inductors are integrated inside the TPSM82480. The inductors are shielded and have an inductance of 0.47 μH with approximately a $\pm 20\%$ tolerance.

8.2 Typical Application

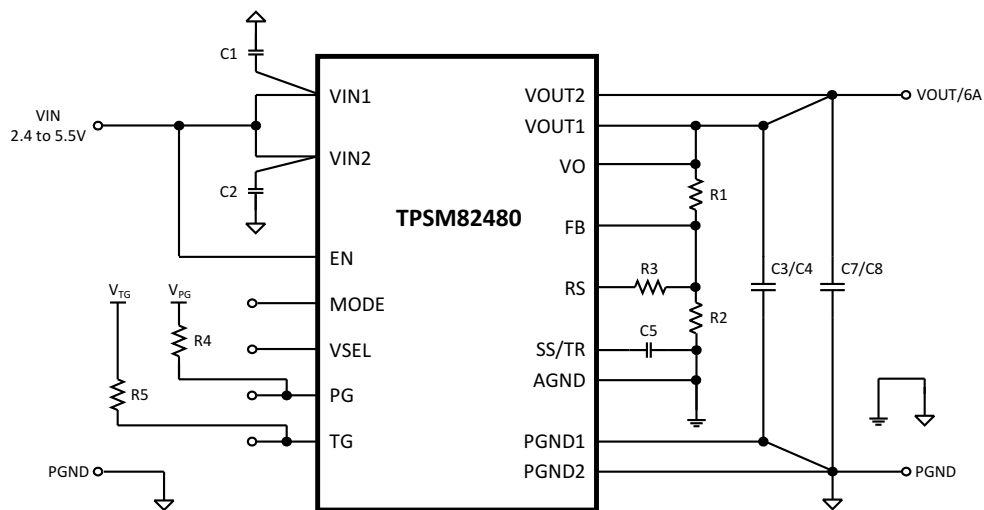

Copyright © 2017, Texas Instruments Incorporated

Figure 7. Typical Application using TPSM82480 for a 6A Point-Of-Load Power Supply

8.2.1 Design Requirements

The following design guideline provides a range for the component selection to operate within the recommended operating conditions. [Table 1](#) shows the components selection that was used for the measurements shown in the [Application Curves](#).

Typical Application (continued)

Table 1. List of Components

REFERENCE	DESCRIPTION	MANUFACTURER
Power Module	5.5-V, 6-A step-down module with integrated inductor	TPSM82480MOP, Texas Instruments
C1, C2	2x22- μ F, 10-V, ceramic, 0603, X5R	GRM188R61A226ME15#, muRata
C3, C4, C7, C8	4x22- μ F, 25-V, ceramic, 0805, X5R	GRM21BR61E226ME44L, muRata
C5	3300-pF, 10-V, ceramic, 0402	Standard
R1, R2, R3	Depending on Vout1 and Vout2, chip, 0402, 0.1%	Standard
R4, R5	470-k Ω , chip, 0603, 1/16-W, 1%	Standard

8.2.2 Detailed Design Procedure

8.2.2.1 Setting the Output Voltage

Choose resistors R1 and R2 to set the output voltage within a range of 0.6 V to 5.5 V, according to [Equation 4](#). To keep the feedback (FB) net robust from noise, set R2 equal to or lower than 120 k Ω to have at least 5 μ A of current in the voltage divider. Lower values of FB resistors achieve better noise immunity, and lower light-load efficiency, as explained in the application report, [Design Considerations For A Resistive Feedback Divider In A DC/DC Converter](#).

$$R_1 = R_2 \times \left(\frac{V_{OUT}}{V_{FB}} - 1 \right) \quad (4)$$

8.2.2.2 Setting V_{OUT2} Using the VSEL Feature

A different output voltage is dynamically set by connecting R₃ between FB and RS pins and pulling VSEL High. R₃ is calculated using [Equation 5](#).

$$R_3 = \frac{V_1 \cdot R_1 \cdot R_2^2}{(V_2 - V_1) \cdot (R_1 \cdot R_2 + R_2^2)} \quad \text{for } (V_2 > V_1)$$

where

- V₁ is the lower level output voltage
 - V₂ the higher level output voltage.
- (5)

8.2.2.3 Feedforward Capacitance

A feedforward capacitor (C_{FF}) is recommended in parallel with R1. The C_{FF} value may be further optimized for a specific application, as explained in the application report, [Optimizing Transient Response of Internally Compensated DC-DC Converters](#).

8.2.2.4 Output Capacitor Selection

The recommended minimum output capacitance is 4 x 22 μ F, that can be ceramic capacitors exclusively. A larger value of output capacitance may be needed for V_{OUT} \leq 1.8 V, to improve transient response performance, as well as for V_{OUT} > 3.3 V to compensate for voltage bias effects of the ceramic capacitors. The usage of an additional feed forward capacitor can help reducing amount of output capacitance that is needed to achieve a certain transient response target (see [Table 3](#)).

The TPSM82480 provides a wide output voltage range from 0.6 V to 5.5 V. While stability is a critical criteria for the output filter selection, the output capacitor value also determines transient response behavior, ripple and accuracy of V_{OUT} . The internal compensation is designed for an output capacitance range from approximately 50 μF to 150 μF effectively. Because ceramic capacitors are used preferably, this translates into nominal values of 4 x 22 μF to 4 x 47 μF and mainly depends on the output voltage. The following table shows recommended capacitor combinations for different output voltage ranges. Combinations without checkmark may not be suitable for all applications:

Table 2. Recommended Output Capacitor Values (nominal)⁽¹⁾

	$V_{OUT} \leq 1.0 \text{ V}$	$1.0 \text{ V} \leq V_{OUT} \leq 3.3 \text{ V}$	$V_{OUT} \geq 3.3 \text{ V}$
2 x 22 μF			
4 x 22 μF		√	
4 x 47 μF	√	√	√
6 x 47 μF			

(1) The values in the table are nominal values. The effective capacitance can differ significantly, depending on package size, voltage rating and dielectric material.

Beyond the recommendations in Table 2, other values can be chosen and might be suitable depending on V_{OUT} and actual effective capacitance. In such case, stability needs to be checked within the actual environment.

Even if the output capacitance is sufficient for stability, a different value might be desirable to improve the transient response behavior. Table 3 can be used to determine capacitor values for specific transient response targets:

Table 3. Recommended Output Capacitor Values (nominal)

Output Voltage [V]	Load Step [A]	Output Capacitor Value ⁽¹⁾	Feedforward Capacitor ⁽¹⁾	Typical Transient Response Accuracy	
				$\pm\text{mV}$	$\pm\%$
1.0	0 - 3	4 x 47 μF	-	50	5
	3 - 6			50	5
1.8	0 - 3	4 x 22 μF	36 pF	50	3
	3 - 6			50	3
2.5	0 - 3	4 x 22 μF	36 pF	62	2.5
	3 - 6			50	2
3.3	0 - 3	4 x 47 μF	36 pF	100	3
	3 - 6			80	2.5

(1) The values in the table are nominal values. The effective capacitance can differ significantly, depending on package size, voltage rating and dielectric material.

The architecture of the TPSM82480 allows the use of tiny ceramic output capacitors with low equivalent series resistance (ESR). These capacitors provide low output voltage ripple and are recommended. To keep its low resistance up to high frequencies and to get narrow capacitance variation with temperature, it is recommended to use X5R or X7R dielectrics. Using even higher values than demanded for stability and transient response has further advantages like smaller voltage ripple and tighter dc output accuracy in Power Save Mode.

8.2.2.5 Input Capacitor Selection

The input current of a buck converter is pulsating. Therefore, a low ESR input capacitor is required to prevent large voltage transients at the source but still providing peak currents to the device. The recommended Capacitance value for most applications is 2 x 10 μF , split between the VIN1 and VIN2 inputs and placed as close as possible to these pins and PGND pins. If additional capacitance is needed, it can be added as bulk capacitance. To ensure proper operation, the effective capacitance at the VIN pins must not fall below 2 x 5 μF .

Low ESR multilayer ceramic capacitors are recommended for best filtering. Increasing with input voltage, the dc bias effect reduces the nominal capacitance value significantly. To decrease input ripple current further, larger values of input capacitors can be used.

8.2.2.6 Soft-Start Capacitor Selection

The soft-start ramp time can be set externally connecting a capacitor between the SS/TR and AGND pins. The capacitor value C_{SS} that is needed to get a specific rising time Δt_{SS} calculates as:

$$C_{SS} = \Delta t_{SS} \cdot \frac{5.25\mu A}{0.6V} \quad (6)$$

Because the device has an internal delay time Δt_{DELAY} from EN=High to start switching, the overall startup time is longer as shown in Figure 8.

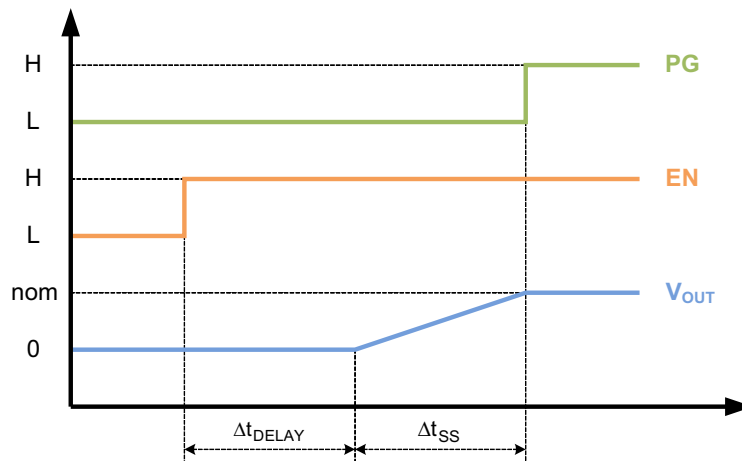

Figure 8. Soft-Start Timing (Δt_{SS})

If very large output capacitances are used (e.g. $>4 \times 47\mu F$), the use of a soft-start capacitor is mandatory to avoid current limit foldback during startup (see [Current Limit and Short Circuit Protection](#)).

8.2.2.7 Tracking

For values up to 0.6V, an external voltage, connected to the SS/TR pin, drives the voltage level at the FB pin. In doing so, the voltage at the FB pin is directly proportional to the voltage at the SS/TR pin.

When choosing the resistive divider proportion according to Equation 7, V_{OUT} tracks V_{TR} simultaneously.

$$\frac{R_1}{R_2} = \frac{R_3}{R_4} \quad (7)$$

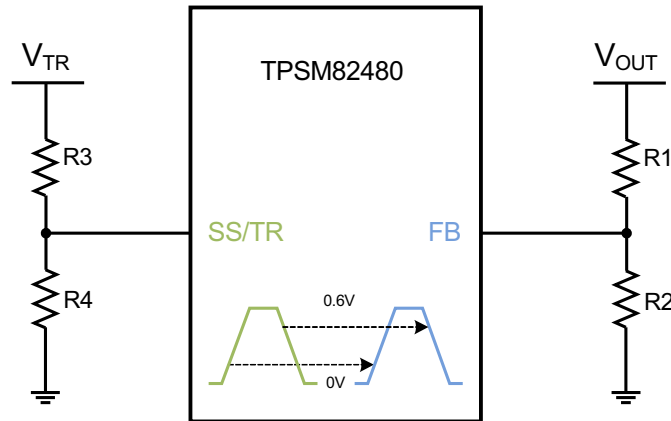

Copyright © 2017, Texas Instruments Incorporated

Figure 9. Voltage Tracking

Following the example of [Setting the Output Voltage](#) with $V_{OUT} = 1.8\text{ V}$, $R_1 = 240\text{ k}\Omega$ and $R_2 = 120\text{ k}\Omega$, [Equation 8](#) and [Equation 9](#) calculate R_3 and R_4 , connected to the SS/TR pin. Different to the resistive divider at the FB pin, a larger current must be chosen, to avoid a tracking offset caused by the $5.25\text{ }\mu\text{A}$ current that flows out of the SS/TR pin. Assuming a $250\text{ }\mu\text{A}$ current, R_4 calculates as follows:

$$R_4 = \frac{0.6\text{ V}}{250\text{ }\mu\text{A}} = 2.4\text{ k}\Omega \quad (8)$$

R_3 calculates now rearranging [Equation 7](#):

$$R_3 = R_4 \cdot \frac{R_1}{R_2} = 2.4\text{ k}\Omega \cdot \frac{240\text{ k}\Omega}{120\text{ k}\Omega} = 4.8\text{ k}\Omega \quad (9)$$

However, the following limitations can influence the tracking accuracy:

- The upper limit of the SS/TR voltage that can be tracked is approximately 0.6V. Because it is detected internally by a comparator, process variation and ramp speed can cause up to $\pm 30\text{ mV}$ different threshold.
- In case that the voltage at SS/TR ramps up immediately when V_{IN} is supplied or EN is set High, the internal startup delay, Δt_{DELAY} , delays the ramp of V_{OUT} . The internal ramp starts after Δt_{DELAY} at the voltage level, which is actually present at the SS/TR pin.
- The tracking down speed is limited by the RC time constant of the internal output discharge (always connected when tracking down) and the actual load with the output capacitance. Note: The device tracks down with the same behavior for MODE High (Forced PWM) and Low (Auto PSM).

8.2.2.8 Thermal Good

The Thermal Good pin provides an open drain output. The logic level is given by the pull up source which can be V_{OUT} . In this case, TG goes or stays Low, when the device switches off due to EN, UVLO or Thermal Shutdown.

When using an independent source for the pull up logic, the logic behavior at shutdown differs, because the TG pin internally goes high impedance. As before, TG goes Low when TG threshold is reached, but goes back High in the event of being switched off (e.g. Thermal Shutdown).

8.2.3 Application Curves

$V_{IN} = 3.6\text{ V}$, $V_{OUT} = 1.8\text{ V}$ ($R1 / R2 = 240\text{ k}\Omega / 120\text{ k}\Omega$), $T_A = 25^\circ\text{C}$, MODE = Low, (unless otherwise noted)

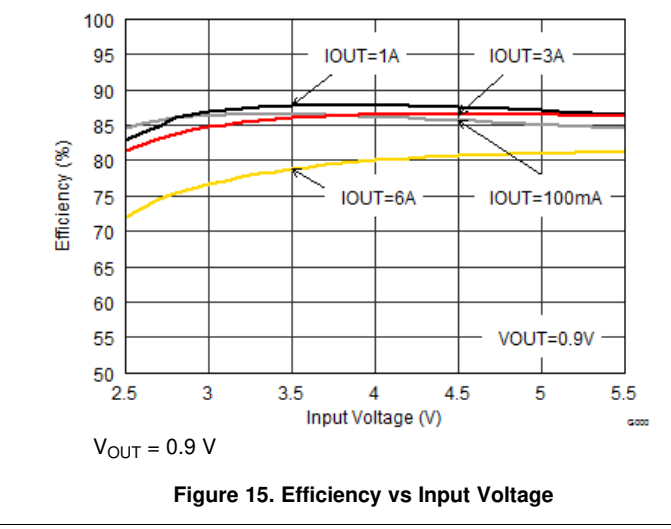
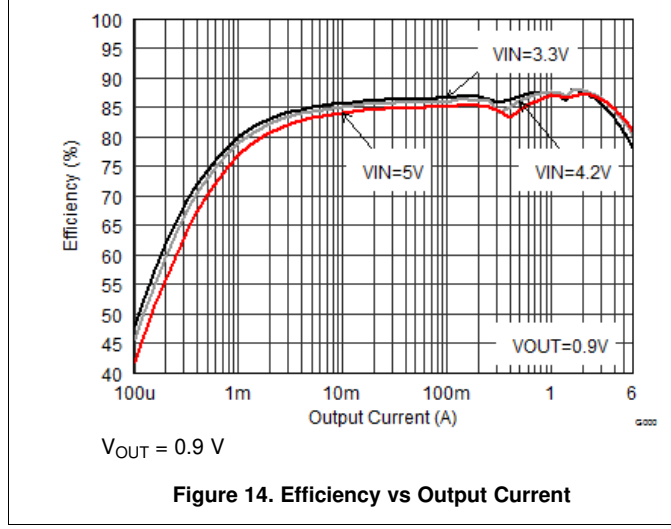
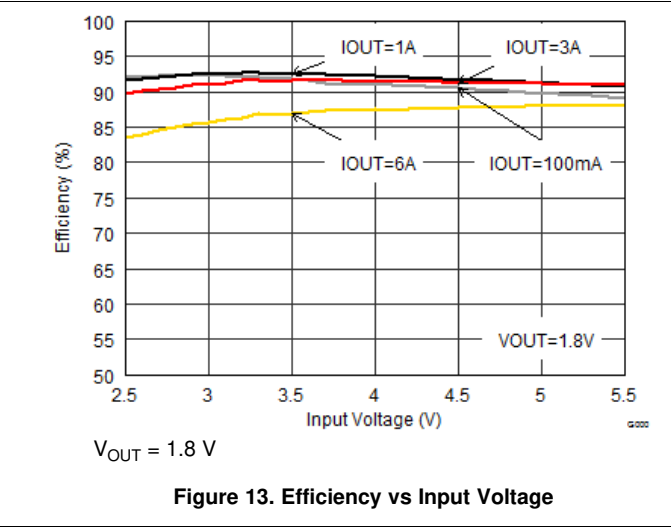
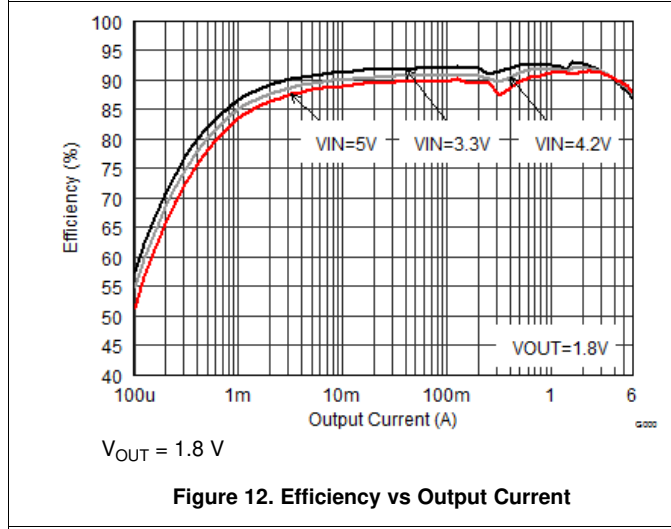
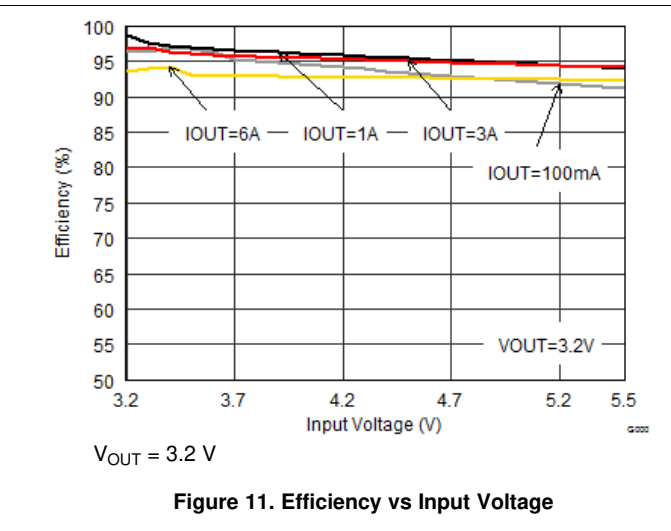
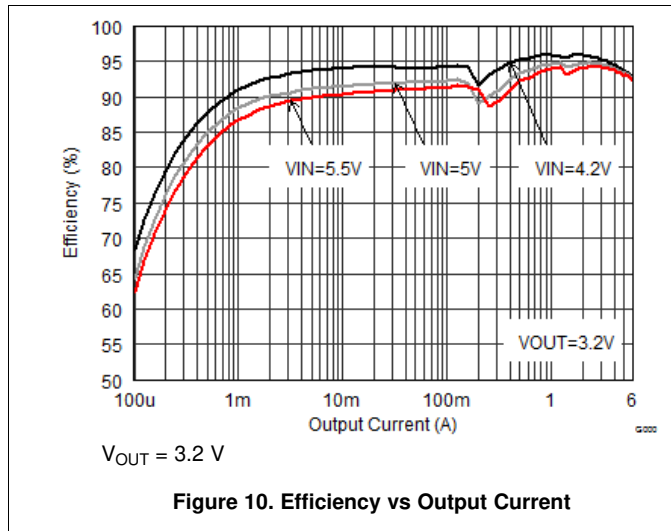

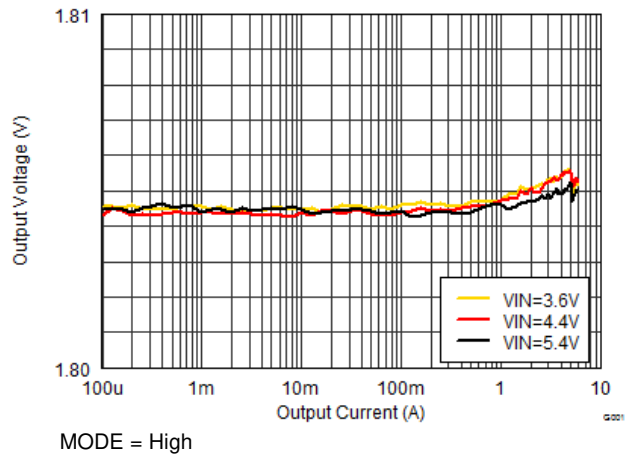

Figure 16. Output Voltage vs Output Current (Load Regulation)

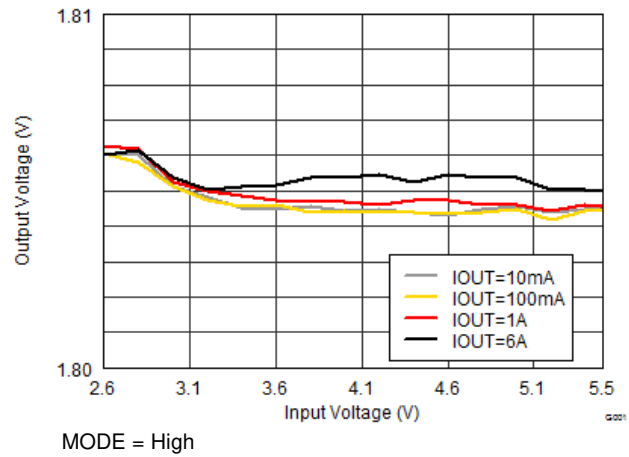

Figure 17. Output Voltage vs Input Voltage (Line Regulation)

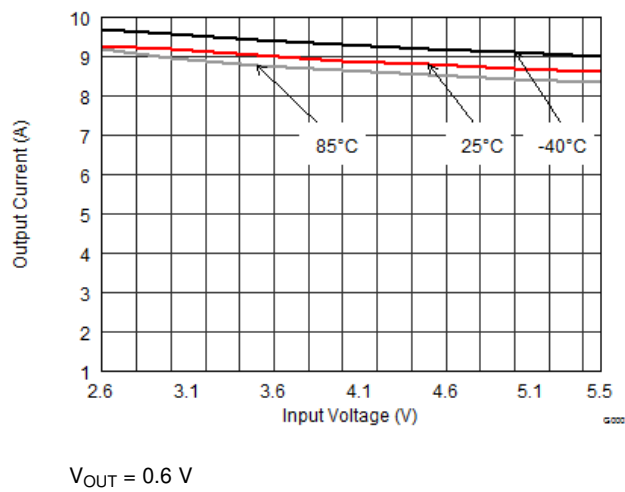

Figure 18. Maximum Output Current

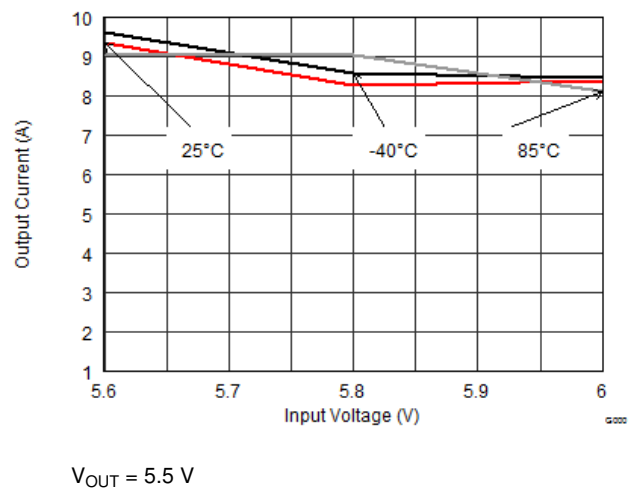

Figure 19. Maximum Output Current

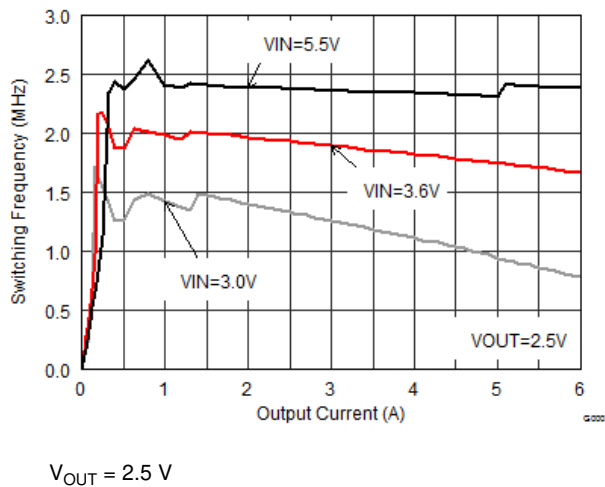

Figure 20. Switching Frequency vs Output Current

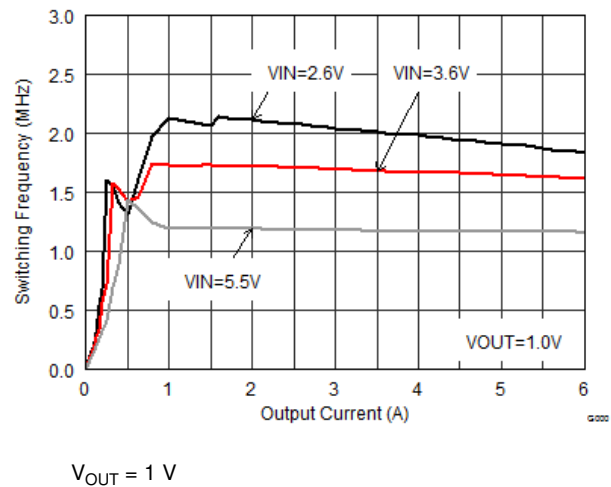

Figure 21. Switching Frequency vs Output Current

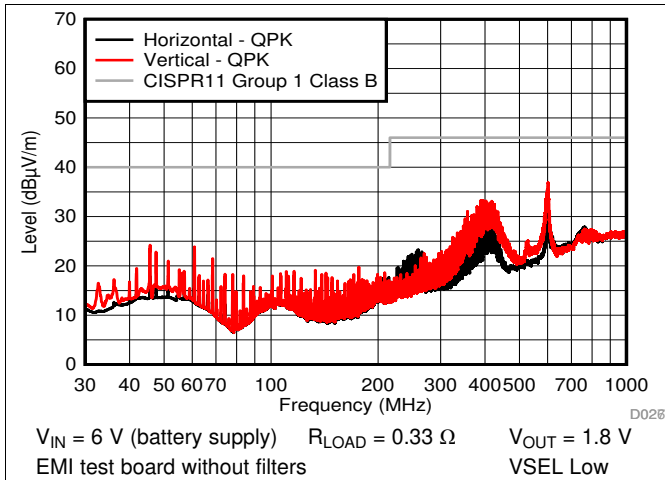

Figure 22. TPSM82480 Radiated Emissions

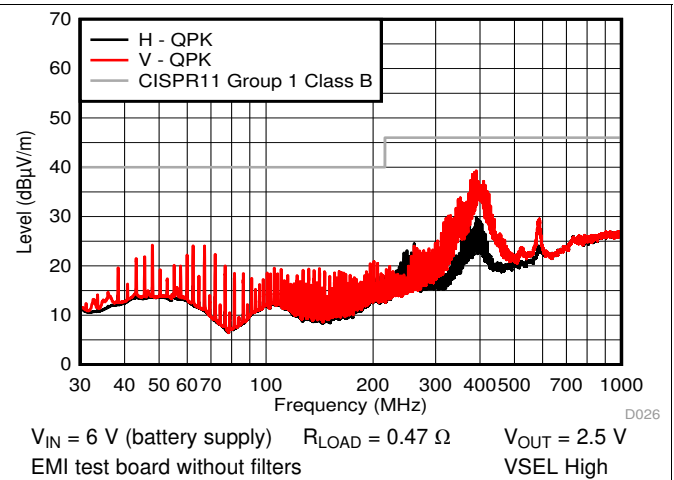

Figure 23. TPSM82480 Radiated Emissions

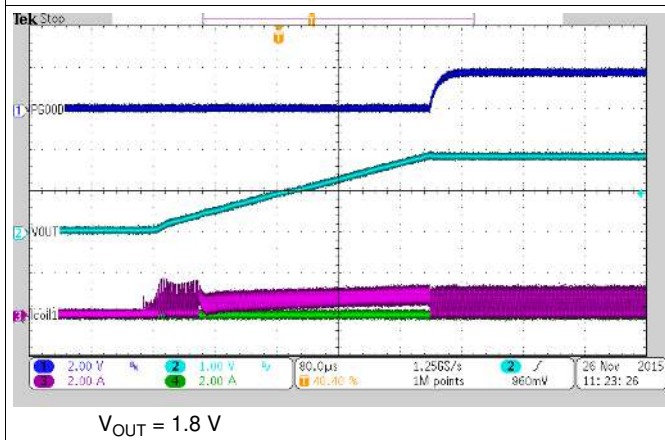

Figure 24. Startup into 3.3 Ω resistor

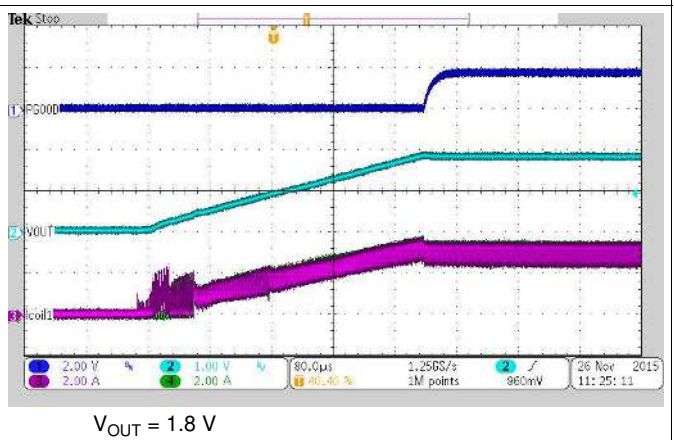

Figure 25. Startup into 0.3 Ω resistor

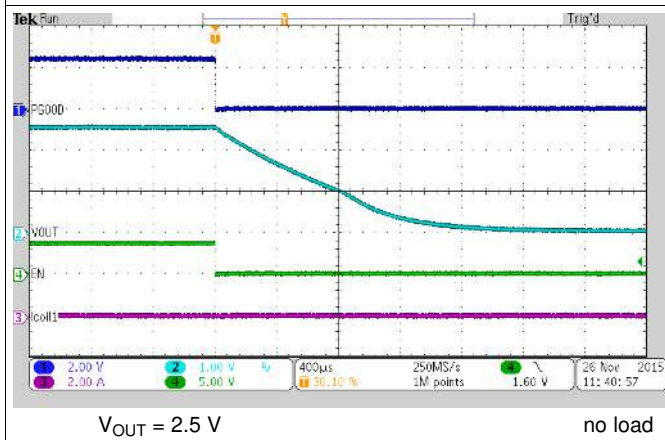

Figure 26. Output Discharge

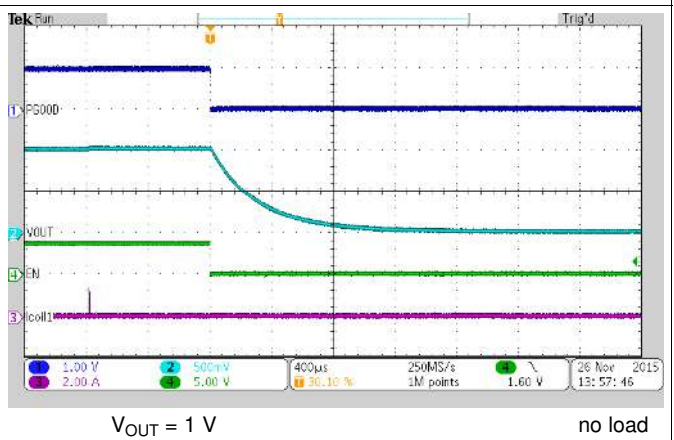

Figure 27. Output Discharge

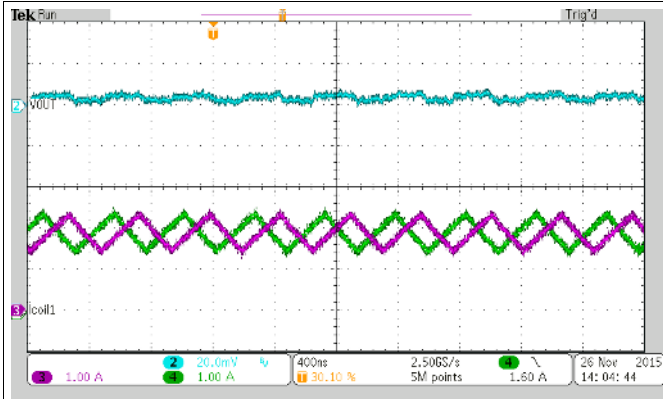
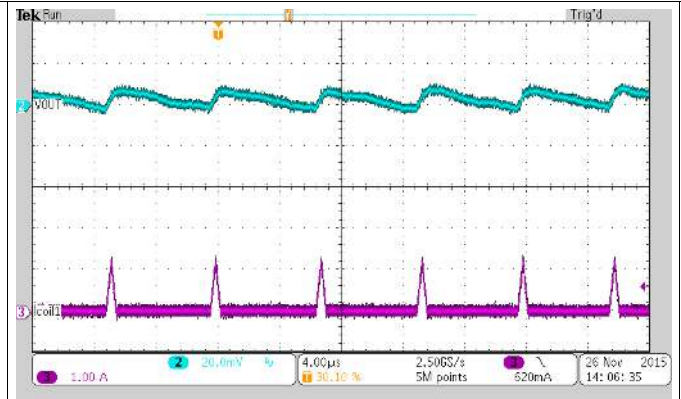

Figure 28. Typical Operation PWM



$I_{OUT} = 50 \text{ mA}$

Figure 29. Typical Operation PSM

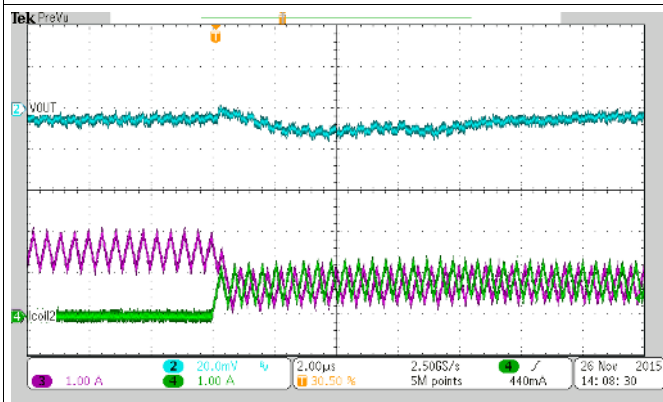

Figure 30. Adding 2nd Phase

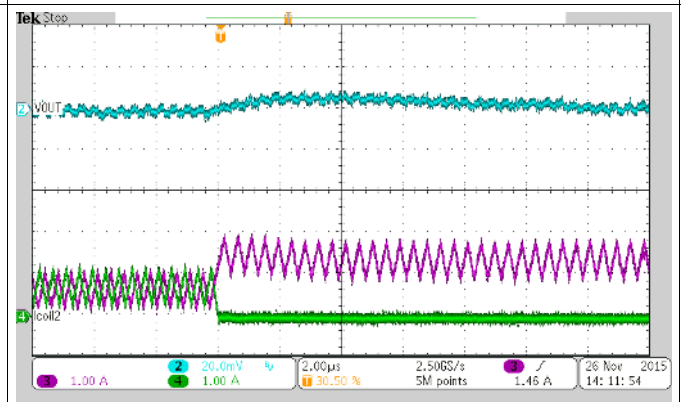

Figure 31. Shedding 2nd Phase

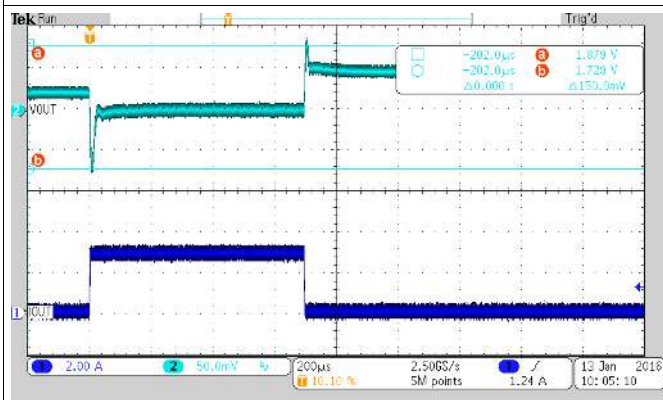
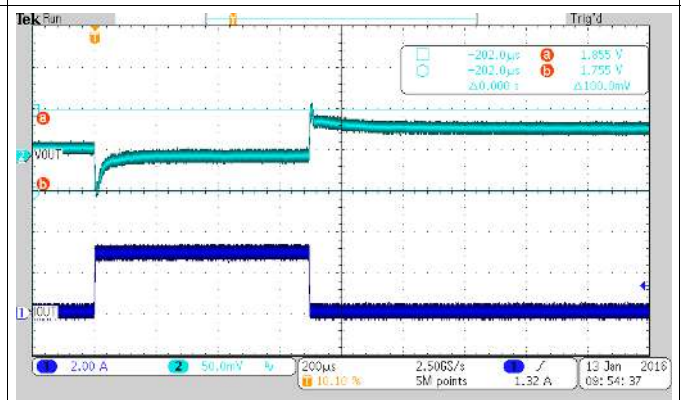

Figure 32. Load Transient Response (PSM-PWM), Load Step 0 to 3 A



$C_{ff} = 36 \text{ pF (nom)}$

Figure 33. Load Transient Response (PSM-PWM), Load Step 0 to 3 A

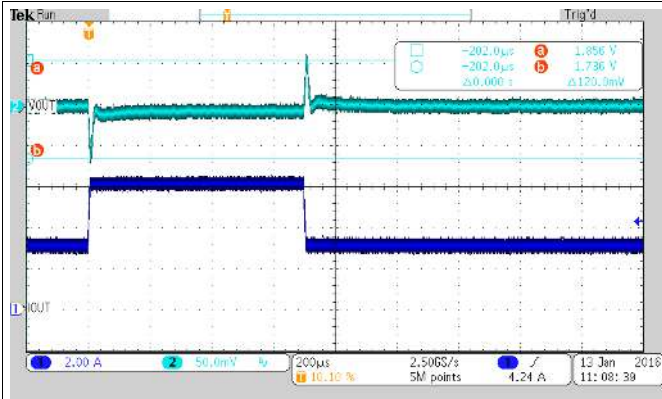
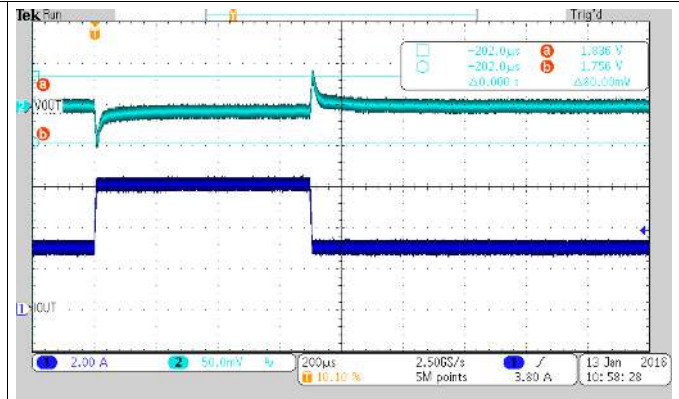
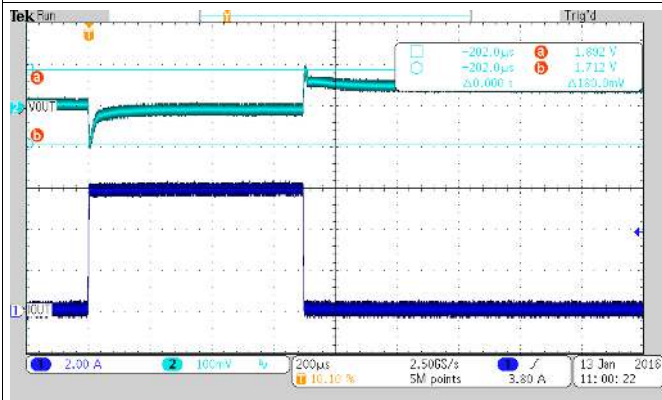

Figure 34. Load Transient Response (PWM-PWM), Load Step 3 to 6 A



$C_{ff} = 36 \text{ pF (nom)}$

Figure 35. Load Transient Response (PWM-PWM), Load Step 3 to 6 A



$C_{ff} = 36 \text{ pF (nom)}$

Figure 36. Load Transient Response (PWM-PWM), Load Step 0 to 6 A

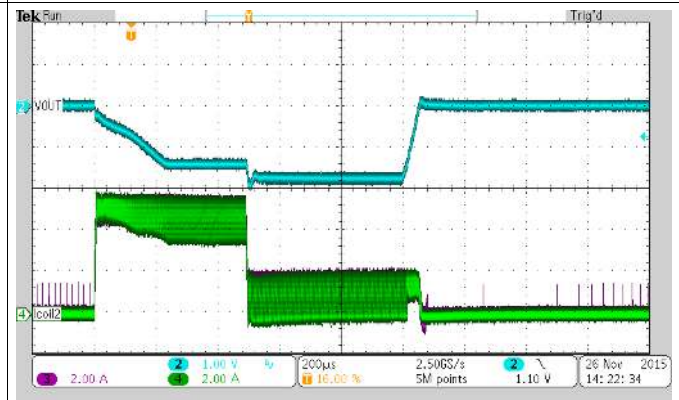

$I_{OUT} = 10 \text{ A}$

Figure 37. Current Limit Fold-Back at Overload

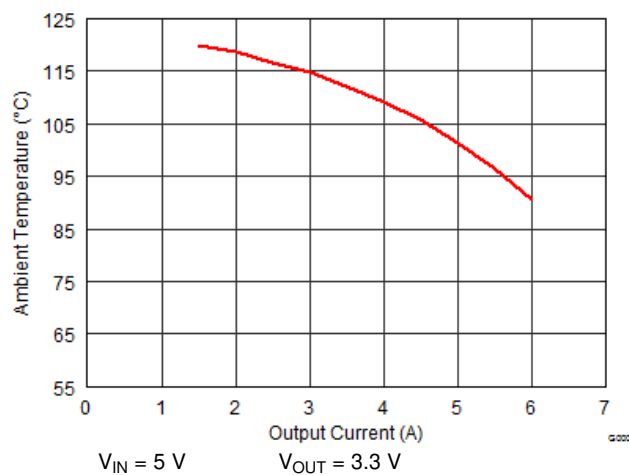

Figure 38. Maximum Ambient Temperature for $T_J=125^\circ\text{C}$ (TPSM82480 EVM)

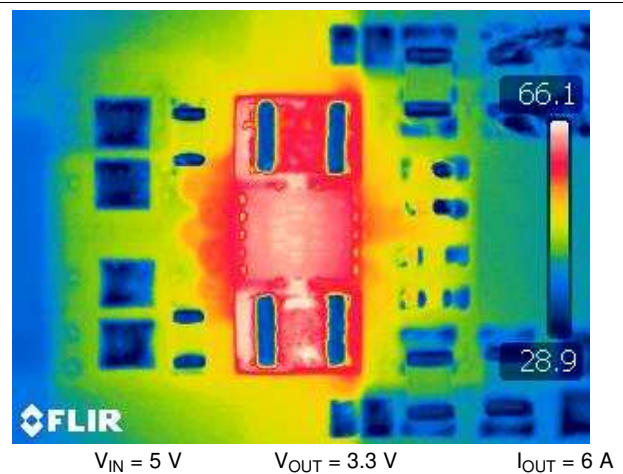
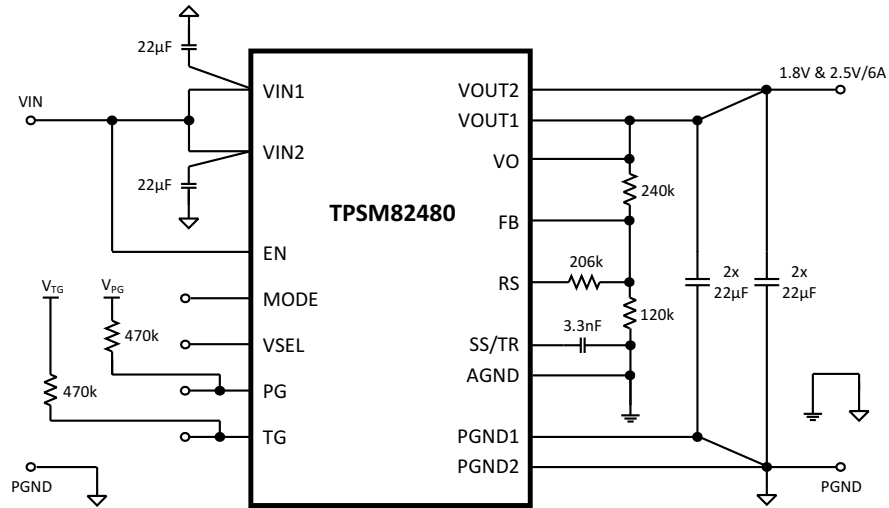

Figure 39. Device Temperature (TPSM82480 EVM)

8.3 System Examples

This section provides typical schematics for commonly used output voltage values.



Copyright © 2017, Texas Instruments Incorporated

Figure 40. A typical 1.8 V & 2.5 V, 6 A Power Supply

Table 4. Resistive Divider Values for Combinations of Output Voltages

V _{OUT}	R1	R2	R3
2.5 V and 3.3 V	380 kΩ	120 kΩ	285 kΩ
1.2 V and 1.8 V	120 kΩ	120 kΩ	120 kΩ
0.9 V and 1.0 V	60 kΩ	120 kΩ	360 kΩ

9 Power Supply Recommendations

The TPSM82480 is designed to operate from a 2.4-V to 5.5-V input voltage supply. The input power supply's output current needs to be rated according to the output voltage and the output current of the power rail application.

10 Layout

10.1 Layout Guidelines

A recommended PCB layout for the TPSM82480 dual phase solution is shown below. It ensures best electrical and optimized thermal performance considering the following important topics:

- Both V_{OUT1} and V_{OUT2} must be connected to build a common VOUT structure.
- The input capacitors must be placed as close as possible to the appropriate pins of the device. This provides low resistive and inductive paths for the high di/dt input current. The input capacitance is split, as is the V_{IN} connection, to avoid interference between the input lines.
- The V_{OUT} regulation loop is closed with C_{OUT} and its ground connection. To avoid PGND noise crosstalk, PGND is kept split for the regulation loop. If a ground layer or plane is used, a direct connection by vias, as shown, is recommended. Otherwise the connection of C_{OUT} to GND must be short for good load regulation.
- The FB node is sensitive to dv/dt signals. Therefore the resistive divider should be placed close to the FB (and R_S pin in case of using R_3) pin, avoiding long trace distance.

For more detailed information about the actual EVM solution, see the [TPSM82480EVM-002 User's Guide](#).

10.2 Layout Example

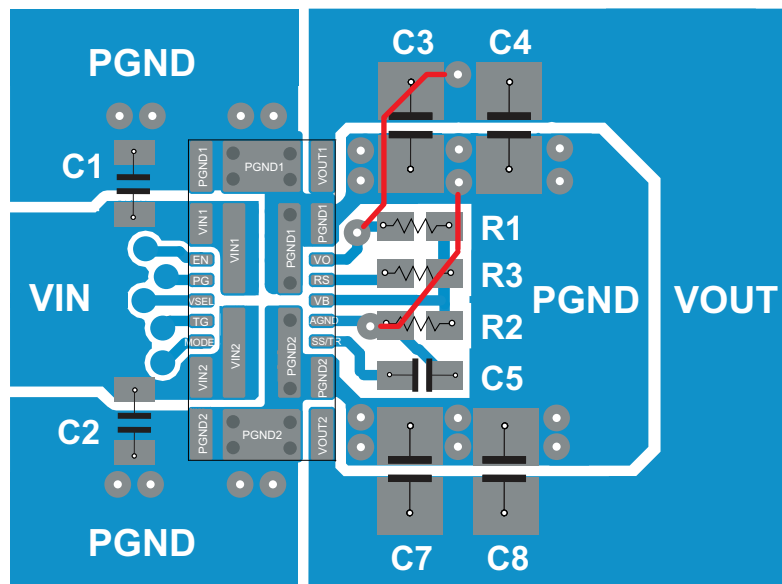

Figure 41. TPSM82480 Board Layout

11 Device and Documentation Support

11.1 Documentation Support

11.1.1 Related Documentation

For related documentation see the following:

- *TPSM82480EVM-BSR002 Evaluation Module User's Guide*, [SLVUB57](#)

11.2 Receiving Notification of Documentation Updates

To receive notification of documentation updates, navigate to the device product folder on ti.com. In the upper right corner, click on *Alert me* to register and receive a weekly digest of any product information that has changed. For change details, review the revision history included in any revised document.

11.3 Community Resources

TI E2E™ support forums are an engineer's go-to source for fast, verified answers and design help — straight from the experts. Search existing answers or ask your own question to get the quick design help you need.

Linked content is provided "AS IS" by the respective contributors. They do not constitute TI specifications and do not necessarily reflect TI's views; see TI's [Terms of Use](#).

11.4 Trademarks

E2E is a trademark of Texas Instruments.

All other trademarks are the property of their respective owners.

11.5 Electrostatic Discharge Caution



These devices have limited built-in ESD protection. The leads should be shorted together or the device placed in conductive foam during storage or handling to prevent electrostatic damage to the MOS gates.

11.6 Glossary

[SLYZ022](#) — *TI Glossary*.

This glossary lists and explains terms, acronyms, and definitions.

12 Mechanical, Packaging, and Orderable Information

The following pages include mechanical, packaging, and orderable information. This information is the most current data available for the designated devices. This data is subject to change without notice and revision of this document. For browser-based versions of this data sheet, refer to the left-hand navigation.

12.1 Tape and Reel Information

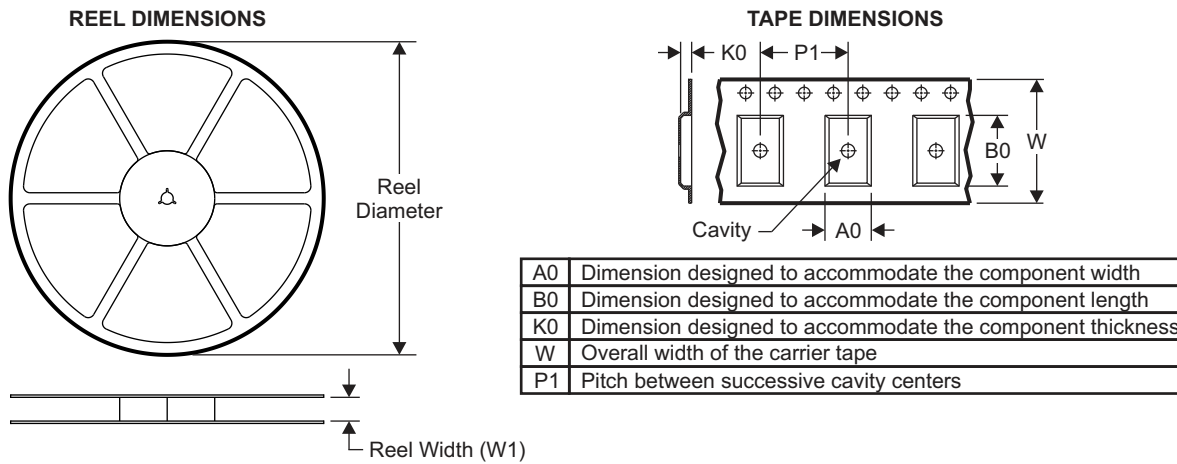

QUADRANT ASSIGNMENTS FOR PIN 1 ORIENTATION IN TAPE

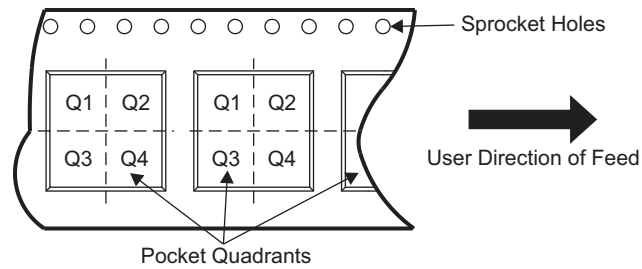

Device	Package Type	Package Drawing	Pins	SPQ	Reel Diameter (mm)	Reel Width W1 (mm)	A0 (mm)	B0 (mm)	K0 (mm)	P1 (mm)	W (mm)	Pin1 Quadrant
TPSM82480MOPR	QFM	MOP	24	3000	330.0	16.0	3.85	8.15	1.7	8.0	16.0	Q2
TPSM82480MOPT	QFM	MOP	24	250	180.0	16.0	3.85	8.15	1.7	8.0	16.0	Q2

TPSM82480

SLVSDT1C – JULY 2017 – REVISED JUNE 2020

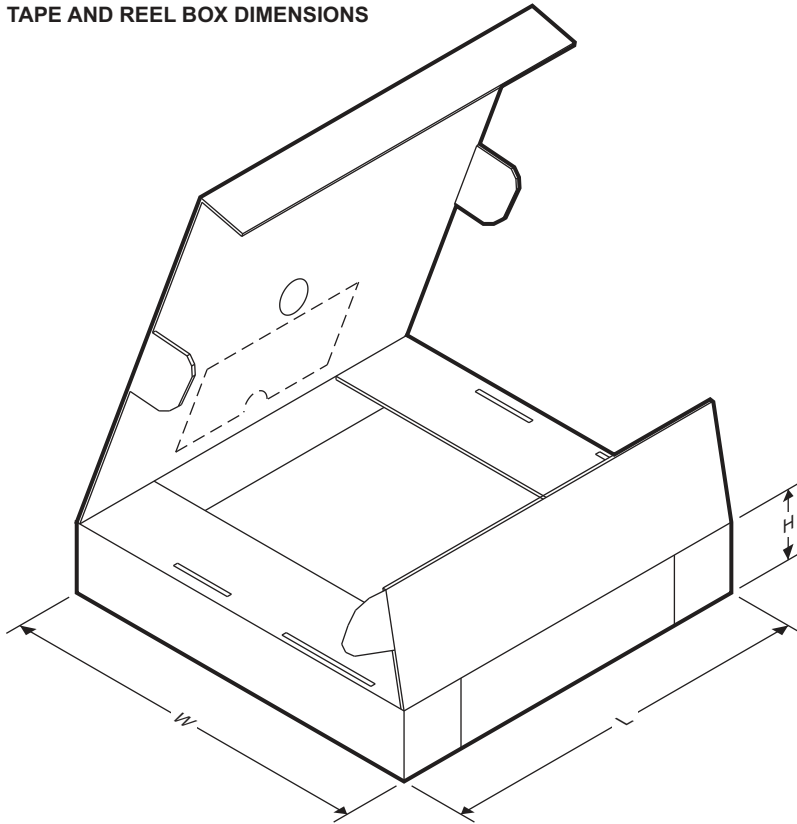
www.ti.com
TAPE AND REEL BOX DIMENSIONS

Device	Package Type	Package Drawing	Pins	SPQ	Length (mm)	Width (mm)	Height (mm)
TPSM82480MOPR	QFM	MOP	24	3000	383.0	353.0	58.0
TPSM82480MOPT	QFM	MOP	24	250	223.0	194.0	35.0

PACKAGING INFORMATION

Orderable Device	Status (1)	Package Type	Package Drawing	Pins	Package Qty	Eco Plan (2)	Lead finish/ Ball material (6)	MSL Peak Temp (3)	Op Temp (°C)	Device Marking (4/5)	Samples
TPSM82480MOPR	ACTIVE	QFM	MOP	24	3000	RoHS & Green	Call TI	Level-2-260C-1 YEAR	-40 to 125	82480	Samples
TPSM82480MOPT	ACTIVE	QFM	MOP	24	250	RoHS & Green	Call TI	Level-2-260C-1 YEAR	-40 to 125	82480	Samples

(1) The marketing status values are defined as follows:

ACTIVE: Product device recommended for new designs.

LIFEBUY: TI has announced that the device will be discontinued, and a lifetime-buy period is in effect.

NRND: Not recommended for new designs. Device is in production to support existing customers, but TI does not recommend using this part in a new design.

PREVIEW: Device has been announced but is not in production. Samples may or may not be available.

OBSOLETE: TI has discontinued the production of the device.

(2) **RoHS:** TI defines "RoHS" to mean semiconductor products that are compliant with the current EU RoHS requirements for all 10 RoHS substances, including the requirement that RoHS substance do not exceed 0.1% by weight in homogeneous materials. Where designed to be soldered at high temperatures, "RoHS" products are suitable for use in specified lead-free processes. TI may reference these types of products as "Pb-Free".

RoHS Exempt: TI defines "RoHS Exempt" to mean products that contain lead but are compliant with EU RoHS pursuant to a specific EU RoHS exemption.

Green: TI defines "Green" to mean the content of Chlorine (Cl) and Bromine (Br) based flame retardants meet JS709B low halogen requirements of <=1000ppm threshold. Antimony trioxide based flame retardants must also meet the <=1000ppm threshold requirement.

(3) MSL, Peak Temp. - The Moisture Sensitivity Level rating according to the JEDEC industry standard classifications, and peak solder temperature.

(4) There may be additional marking, which relates to the logo, the lot trace code information, or the environmental category on the device.

(5) Multiple Device Markings will be inside parentheses. Only one Device Marking contained in parentheses and separated by a "~" will appear on a device. If a line is indented then it is a continuation of the previous line and the two combined represent the entire Device Marking for that device.

(6) Lead finish/Ball material - Orderable Devices may have multiple material finish options. Finish options are separated by a vertical ruled line. Lead finish/Ball material values may wrap to two lines if the finish value exceeds the maximum column width.

Important Information and Disclaimer:The information provided on this page represents TI's knowledge and belief as of the date that it is provided. TI bases its knowledge and belief on information provided by third parties, and makes no representation or warranty as to the accuracy of such information. Efforts are underway to better integrate information from third parties. TI has taken and continues to take reasonable steps to provide representative and accurate information but may not have conducted destructive testing or chemical analysis on incoming materials and chemicals. TI and TI suppliers consider certain information to be proprietary, and thus CAS numbers and other limited information may not be available for release.

In no event shall TI's liability arising out of such information exceed the total purchase price of the TI part(s) at issue in this document sold by TI to Customer on an annual basis.

MOP0024A

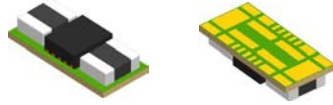

PACKAGE OUTLINE

QFM - 1.55 mm max height

QUAD FLAT MODULE

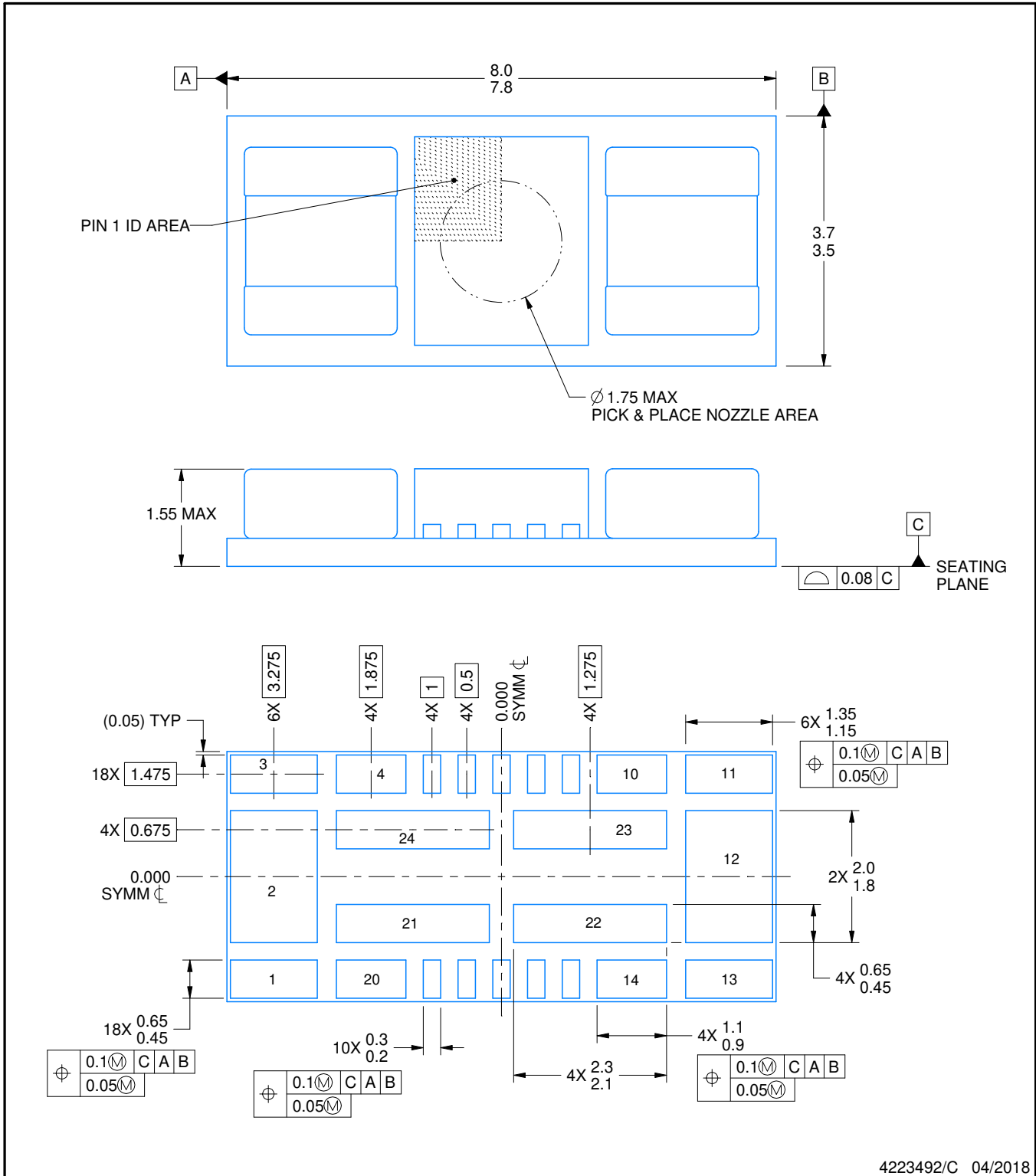

NOTES:

1. All linear dimensions are in millimeters. Any dimensions in parenthesis are for reference only. Dimensioning and tolerancing per ASME Y14.5M.
2. This drawing is subject to change without notice.

EXAMPLE BOARD LAYOUT

MOP0024A

QFM - 1.55 mm max height

QUAD FLAT MODULE

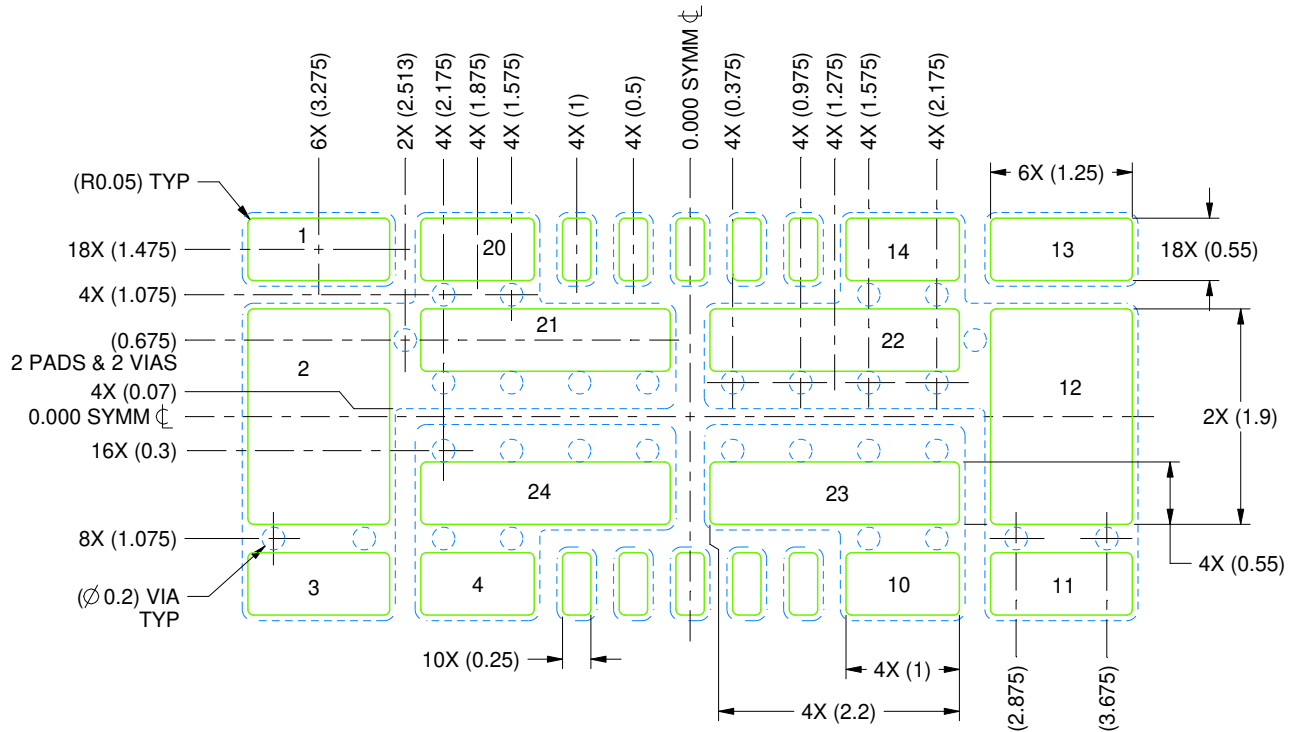

LAND PATTERN EXAMPLE
SOLDER MASK DEFINED
SCALE:15X

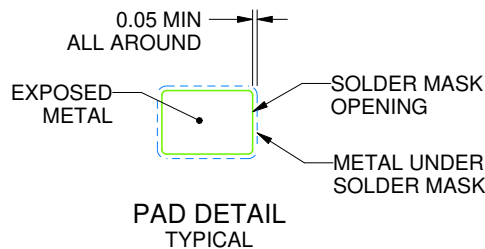

4223492/C 04/2018

NOTES: (continued)

- 3. This package is designed to be soldered to thermal pads on the board. For more information, see Texas Instruments literature number SLUA271 (www.ti.com/lit/slua271).
- 4. Vias are optional depending on application, refer to device data sheet. If any vias are implemented, refer to their locations shown on this view.

EXAMPLE STENCIL DESIGN

MOP0024A

QFM - 1.55 mm max height

QUAD FLAT MODULE

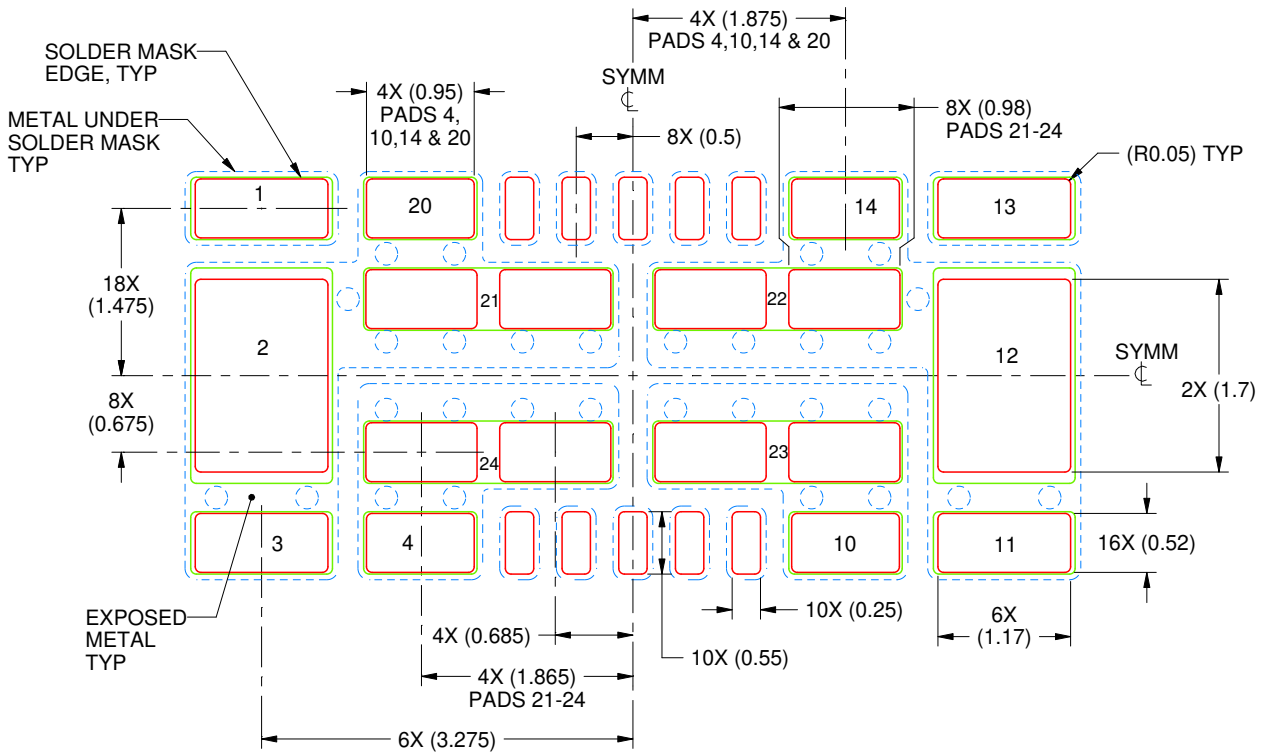

SOLDER PASTE EXAMPLE
BASED ON 0.125 mm THICK STENCIL

PRINTED SOLDER COVERAGE BY AREA UNDER PACKAGE

PADS 1, 3, 11 & 13: 88%

PADS 4, 10, 14 & 20: 90%

PADS 2, 12 & 21-24: 84%

SCALE:15X

4223492/C 04/2018

NOTES: (continued)

5. Laser cutting apertures with trapezoidal walls and rounded corners may offer better paste release. IPC-7525 may have alternate design recommendations.

IMPORTANT NOTICE AND DISCLAIMER

TI PROVIDES TECHNICAL AND RELIABILITY DATA (INCLUDING DATASHEETS), DESIGN RESOURCES (INCLUDING REFERENCE DESIGNS), APPLICATION OR OTHER DESIGN ADVICE, WEB TOOLS, SAFETY INFORMATION, AND OTHER RESOURCES "AS IS" AND WITH ALL FAULTS, AND DISCLAIMS ALL WARRANTIES, EXPRESS AND IMPLIED, INCLUDING WITHOUT LIMITATION ANY IMPLIED WARRANTIES OF MERCHANTABILITY, FITNESS FOR A PARTICULAR PURPOSE OR NON-INFRINGEMENT OF THIRD PARTY INTELLECTUAL PROPERTY RIGHTS.

These resources are intended for skilled developers designing with TI products. You are solely responsible for (1) selecting the appropriate TI products for your application, (2) designing, validating and testing your application, and (3) ensuring your application meets applicable standards, and any other safety, security, or other requirements. These resources are subject to change without notice. TI grants you permission to use these resources only for development of an application that uses the TI products described in the resource. Other reproduction and display of these resources is prohibited. No license is granted to any other TI intellectual property right or to any third party intellectual property right. TI disclaims responsibility for, and you will fully indemnify TI and its representatives against, any claims, damages, costs, losses, and liabilities arising out of your use of these resources.

TI's products are provided subject to TI's Terms of Sale (<https://www.ti.com/legal/termsofsale.html>) or other applicable terms available either on [ti.com](https://www.ti.com) or provided in conjunction with such TI products. TI's provision of these resources does not expand or otherwise alter TI's applicable warranties or warranty disclaimers for TI products.

Mailing Address: Texas Instruments, Post Office Box 655303, Dallas, Texas 75265
Copyright © 2021, Texas Instruments Incorporated