

### FEATURES

- 2 GHz to 6 GHz
- 21 dB typical small signal gain
- 45 dBm typical saturated RF output power ( $P_{out}$ )
- 18-lead, hermetically sealed module
- 30°C to +60°C operating temperature

### APPLICATIONS

- Test and measurement equipment
- Communications
- Electronic warfare (EW)
- Military
- Traveling wave tube (TWT) replacements
- SATCOM
- Commercial and military radars

### GENERAL DESCRIPTION

The HMC7885 is a 32 W gallium nitride (GaN), monolithic microwave integrated circuit (MMIC) power amplifier (PA) module that operates between 2 GHz and 6 GHz, and is provided in an 18-lead hermetically sealed module. The amplifier typically provides 21 dB of small signal gain and 45 dBm of saturated radio frequency (RF) output power. The amplifier draws 2200 mA of quiescent current ( $I_{DD}$ ) from a 28 V dc supply. The RF input and output are dc blocked and matched to 50  $\Omega$  for ease of use.

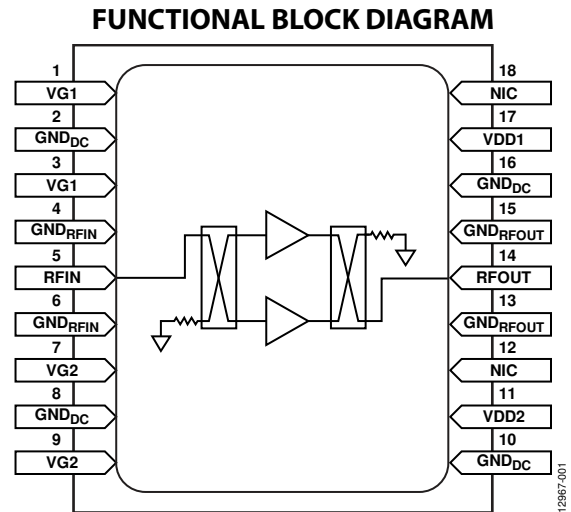

Figure 1.

**TABLE OF CONTENTS**

Features .....	1	Pin Configuration and Function Descriptions.....	5
Applications.....	1	Typical Performance Characteristics .....	6
General Description .....	1	Applications Information .....	9
Functional Block Diagram .....	1	Evaluation Board Assembly .....	10
Revision History .....	2	Bill of Materials.....	10
Specifications.....	3	Outline Dimensions .....	11
Absolute Maximum Ratings.....	4	Ordering Guide .....	11
ESD Caution.....	4		

**REVISION HISTORY**

**1/2017—Revision 0: Initial Version**

## SPECIFICATIONS

VDD = VDD1 = VDD2 = 28 V dc, VGG = VG1 = VG2, T<sub>A</sub> = 25°C, unless otherwise noted. Adjust VGG between -5 V to 0 V to achieve a total I<sub>DD</sub> = 2200 mA typical (1100 mA per side).

Table 1.

Parameter	Min	Typ	Max	Unit	Test Conditions/Comments
FREQUENCY RANGE	2		6	GHz	
GAIN					
Small Signal Gain		21		dB	
Power Gain		17		dB	
Gain Flatness		±2		dB	
VOLTAGE STANDING WAVE RATIO (VSWR)					
Input		2:1			
Output		2:1			
RF OUTPUT					
Saturated Output Power (P <sub>SAT</sub> )		45		dBm	5 dB compression with continuous wave (CW) input
Output Power for 1 dB Compression (P1dB)		39		dBm	
Output Third-Order Intercept (IP3)		53		dBm	
Linear Power Output		34		dBm	
POWER ADDED EFFICIENCY (PAE)		25		%	At P <sub>SAT</sub>

## ABSOLUTE MAXIMUM RATINGS

Table 2.

Parameter	Rating
Drain Bias Voltage (VDD1, VDD2)	32 V
Gate Bias Voltage (VG1, VG2)	–8 V dc to 0 V dc
RF Input (RFIN) Power	36 dBm
Operating Temperature <sup>1</sup>	–30°C to +60°C
Junction Temperature (T <sub>j</sub> )	225°C
Storage Temperature <sup>2</sup>	–65°C to +150°C

<sup>1</sup> For operation with a continuous wave input.

<sup>2</sup> This device is not surface mountable and is not intended nor suitable for use in a solder reflow process. This device must not be exposed to ambient temperatures above 150°C.

Stresses at or above those listed under Absolute Maximum Ratings may cause permanent damage to the product. This is a stress rating only; functional operation of the product at these or any other conditions above those indicated in the operational section of this specification is not implied. Operation beyond the maximum operating conditions for extended periods may affect product reliability.

## ESD CAUTION



**ESD (electrostatic discharge) sensitive device.** Charged devices and circuit boards can discharge without detection. Although this product features patented or proprietary protection circuitry, damage may occur on devices subjected to high energy ESD. Therefore, proper ESD precautions should be taken to avoid performance degradation or loss of functionality.

# PIN CONFIGURATION AND FUNCTION DESCRIPTIONS

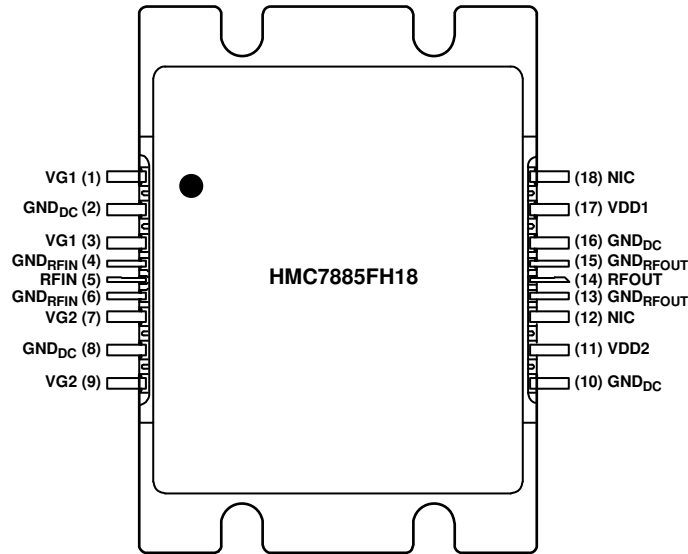

**NOTES**  
 1. THE PACKAGE BASE MUST BE MOUNTED TO A SUITABLE HEAT SINK FOR THE RF AND DC GROUND. IT IS RECOMMENDED TO USE 0-80 SOCKET CAP SCREWS.

12967-002

Figure 2. Pin Configuration

Table 3. Pin Function Descriptions

Pin No.	Mnemonic	Description
1	VG1	Supply Voltage for MMIC 1 Gates. This pin is typically –1.3 V dc. Pin 1 is connected internally to Pin 3.
2	GND <sub>DC</sub>	Power Supply Ground.
3	VG1	Supply Voltage for MMIC 1 Gates. This pin is typically –1.3 V dc. Pin 3 is connected internally to Pin 1.
4	GND <sub>RFIN</sub>	RF Input Ground.
5	RFIN	RF Input. This pin is dc-coupled and matched to 50 Ω.
6	GND <sub>RFIN</sub>	RF Input Ground.
7	VG2	Supply Voltage for MMIC 2 Gates. This pin is typically –1.3 V dc. Pin 7 is connected internally to Pin 9.
8	GND <sub>DC</sub>	Power Supply Ground.
9	VG2	Supply Voltage for MMIC 2 Gates. This pin is typically –1.3 V dc. Pin 9 is connected internally to Pin 7.
10	GND <sub>DC</sub>	Power Supply Ground.
11	VDD2	Supply Voltage for MMIC 2 Drains.
12	NIC	Not Internally Connected. However, this pin can be connected externally to the RF and/or dc ground.
13	GND <sub>RFOUT</sub>	RF Output Ground.
14	RFOUT	RF Output. This pin is ac-coupled and matched to 50 Ω.
15	GND <sub>RFOUT</sub>	RF Output Ground.
16	GND <sub>DC</sub>	Power Supply Ground.
17	VDD1	Supply Voltage for MMIC 1 Drains.
18	NIC	Not Internally Connected. However, this pin can be connected externally to the RF and/or dc ground.
Package Base	GND	The package base must be mounted to a suitable heat sink for the RF and dc ground. It is recommended to use 0-80 socket cap screws.

### TYPICAL PERFORMANCE CHARACTERISTICS

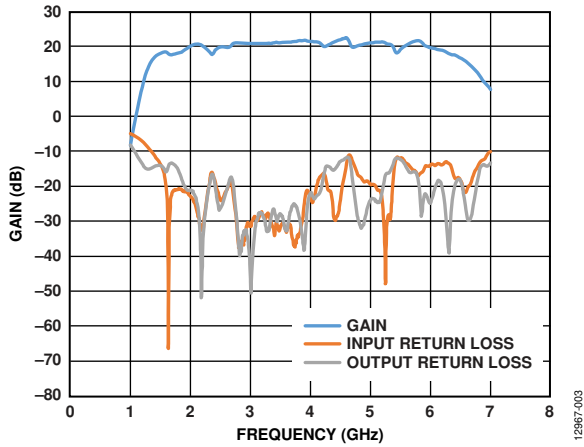

Figure 3. Gain and Input/Output Return Loss vs. Frequency

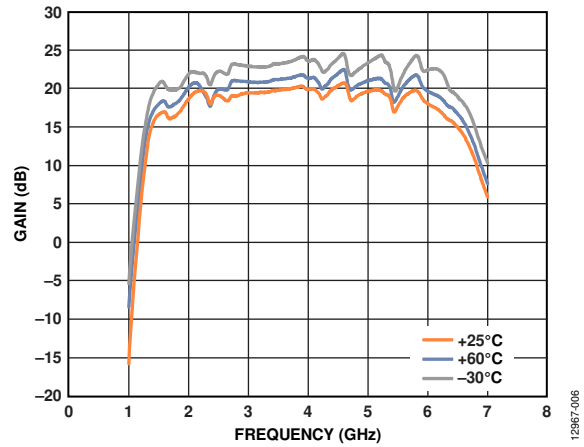

Figure 6. Gain vs. Frequency at Various Temperatures

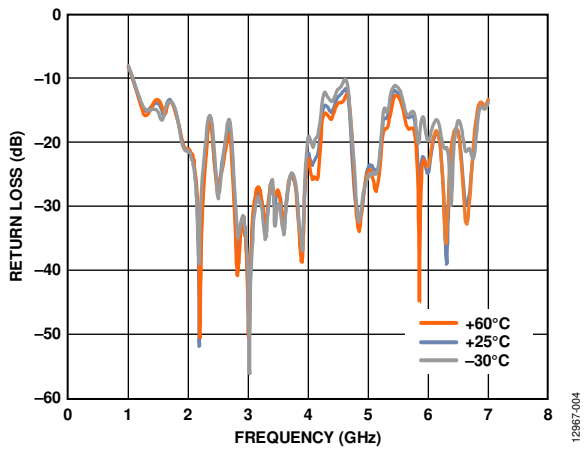

Figure 4. Output Return Loss vs. Frequency at Various Temperatures

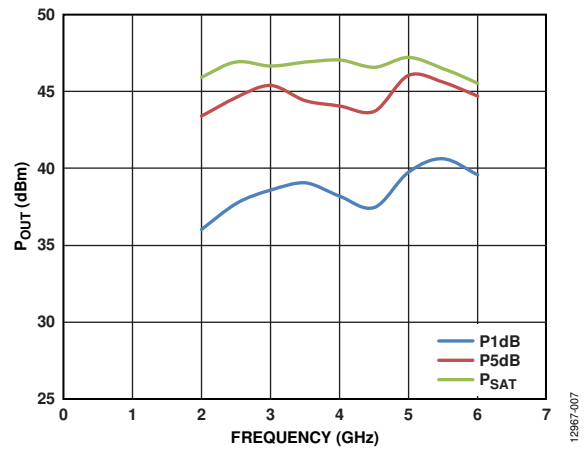

Figure 7.  $P_{OUT}$  vs. Frequency for P1dB, Output Power for 5 dB Compression (P5dB), and  $P_{SAT}$

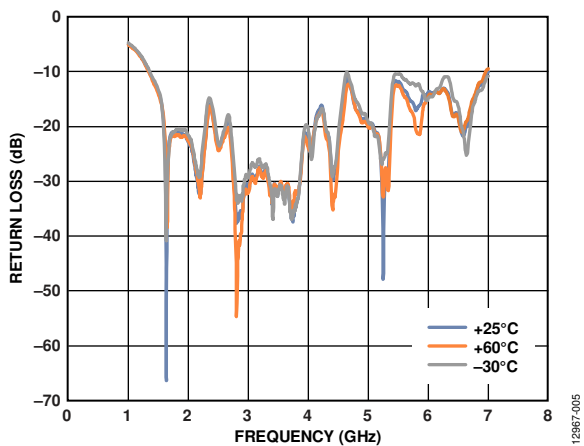

Figure 5. Input Return Loss vs. Frequency at Various Temperatures

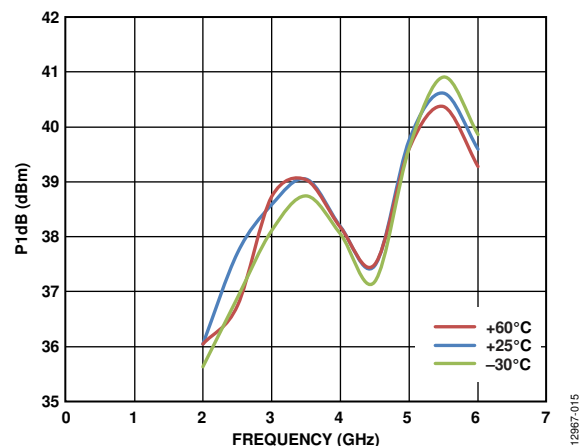

Figure 8. P1dB vs. Frequency at Various Temperatures

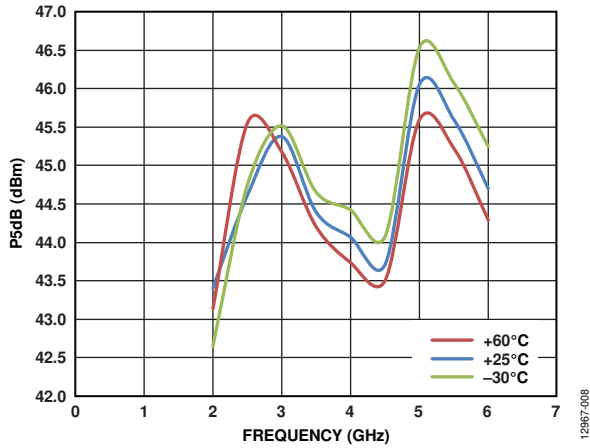

Figure 9. P5dB vs. Frequency at Various Temperatures

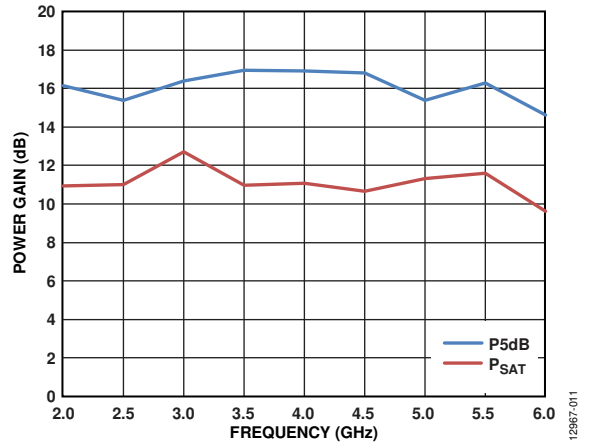

Figure 11. Power Gain vs. Frequency for P5dB and P<sub>SAT</sub>

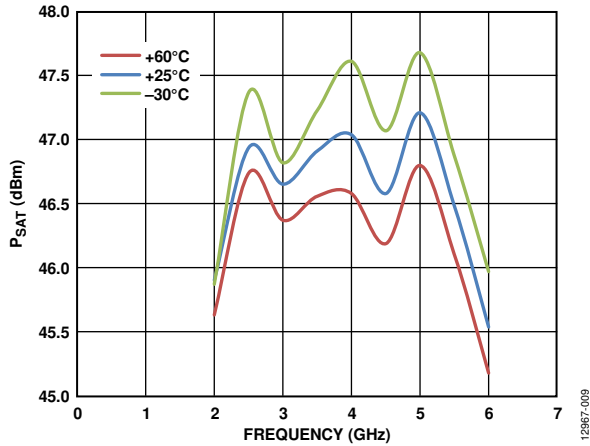

Figure 10. P<sub>SAT</sub> vs. Frequency at Various Temperatures

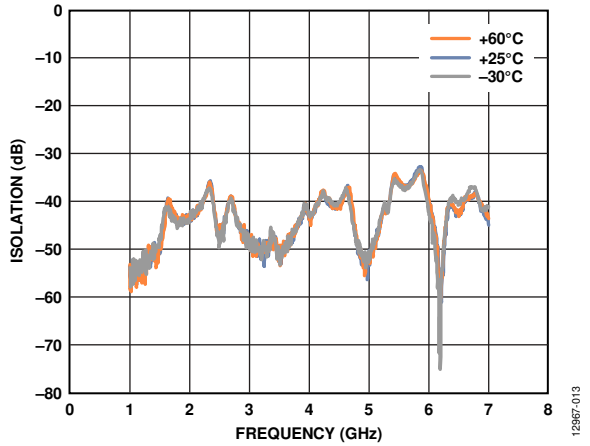

Figure 12. Reverse Isolation vs. Frequency at Various Temperatures

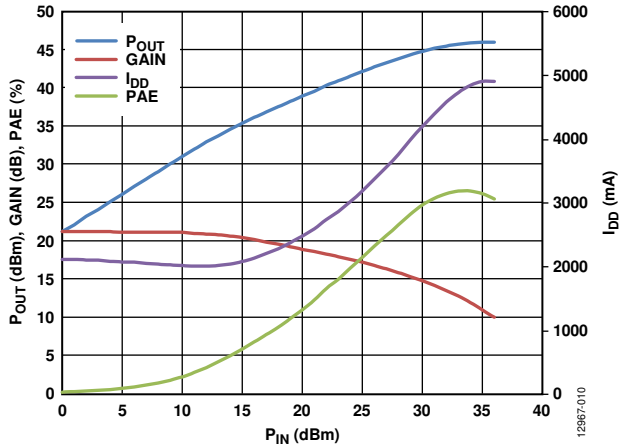

Figure 13. Power Compression at 2 GHz

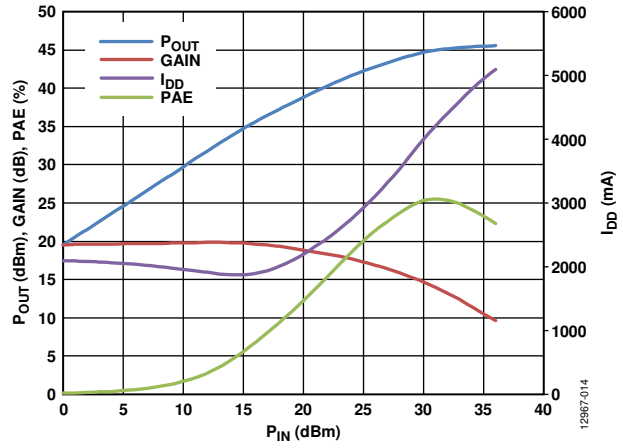

Figure 15. Power Compression at 6 GHz

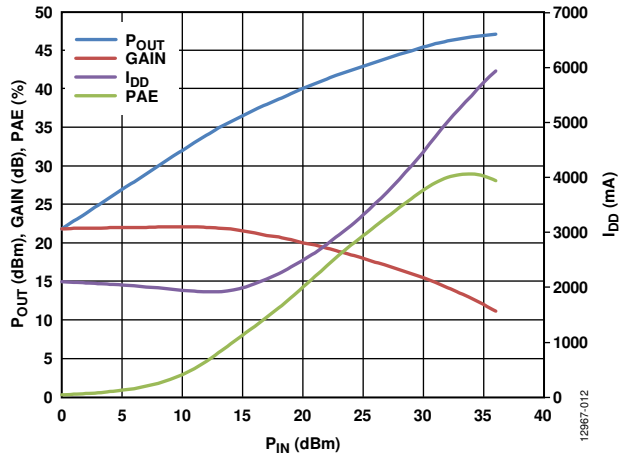

Figure 14. Power Compression at 4 GHz



## APPLICATIONS INFORMATION

To turn on the amplifier, complete the following steps:

1. Set VG1 and VG2 to  $-5$  V.
2. Set VDD1 and VDD2 to  $+28$  V.
3. Ramp the gate voltage until the quiescent current ( $I_{DD}$ ) =  $1100$  mA per side ( $2200$  mA total).
4. Apply the RF input power.

To turn off the amplifier, complete the following steps:

1. Remove the RF input power.
2. Set VG1 and VG2 to  $-5$  V.
3. Set VDD1 and VDD2 to  $0$  V.
4. Set VG1 and VG2 to  $0$  V.

EVALUATION BOARD ASSEMBLY

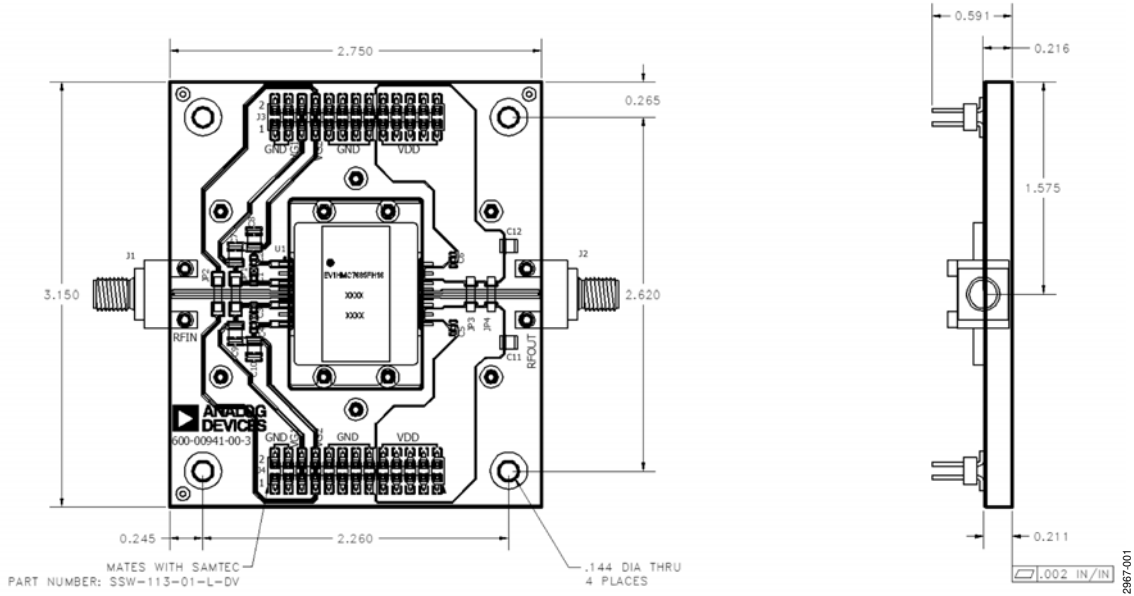

Figure 16. Evaluation Fixture

**BILL OF MATERIALS**

Use RF circuit design techniques for the circuit board used in the application. Provide 50 Ω impedance for the signal lines, and connect the package ground leads and package base directly to the ground plane. DC bias voltages can be applied through either J3 or J4. The evaluation board shown is available from Analog Devices, Inc., upon request.

**Table 4. Bill of Materials for Evaluation Board Assembly EV1HMC7885FH18**

Item	Description
J1, J2	SMA jack
J3, J4	DC, 0.1" terminal strip
JP1 to JP4	6.9 mm, SMT jumper
C1 to C6	1 μF capacitors, 0603 package
C7 to C10	10 μF capacitor, 1210 package
U1	<a href="#">HMC7885FH18</a>
PCB	600-00941-00 evaluation printed circuit board (PCB); circuit board material: Rogers 4350B

OUTLINE DIMENSIONS

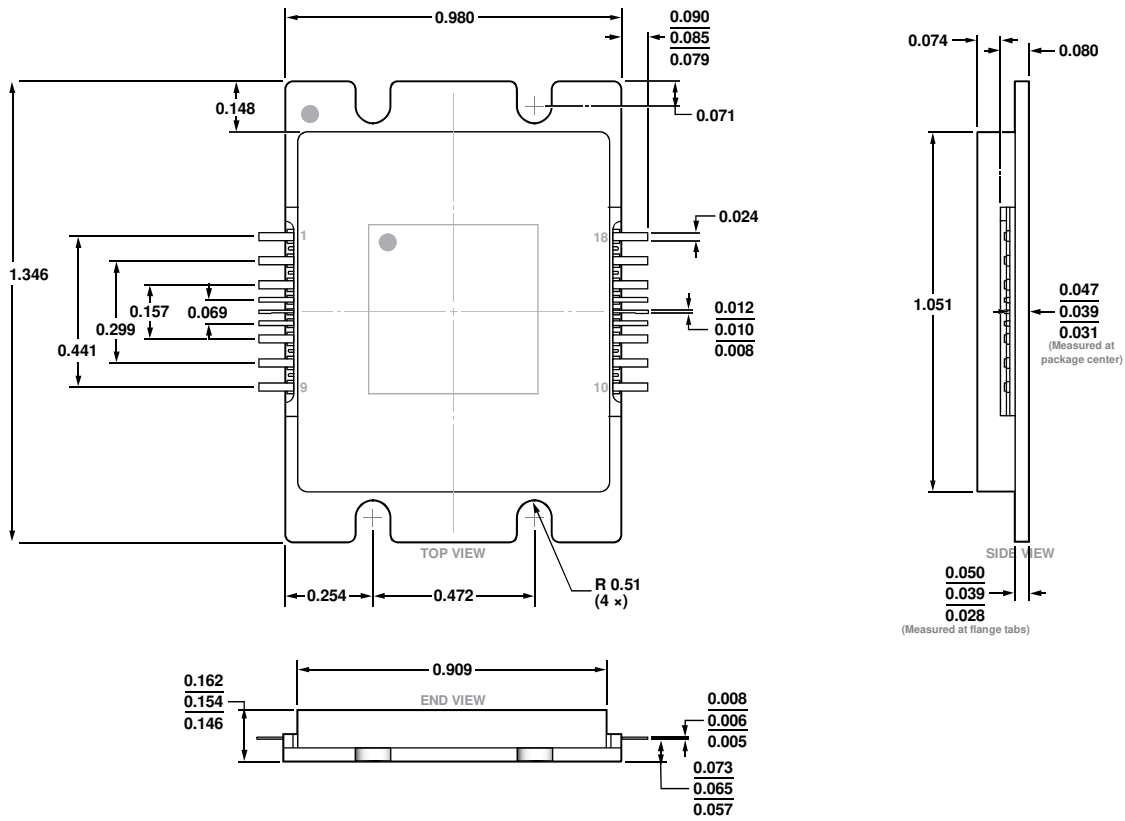

Figure 17. 18-Lead Multichip Module Hermetic Ceramic/Metal Package [CM] (MC-18-1)  
Dimensions shown in inches

ORDERING GUIDE

Model <sup>1</sup>	Temperature Range	Package Description	Package Option
HMC7885FH18	-30°C to +60°C	18-Lead Multichip Module Hermetic Ceramic/Metal Package [CM]	MC-18-1
EV1HMC7885FH18		Evaluation Board	

<sup>1</sup> The HMC7885FH18 is an RoHS-compliant part.