

Hex D Flip-Flop with Common Clock and Reset with LSTTL Compatible Inputs High-Performance Silicon-Gate CMOS

The MC74HCT174A is identical in pinout to the LS174. This device may be used as a level converter for interfacing TTL or NMOS outputs to High Speed CMOS inputs.

This device consists of six D flip-flops with common Clock and Reset inputs. Each flip-flop is loaded with a low-to-high transition of the Clock input. Reset is asynchronous and active-low.

- Output Drive Capability: 10 LSTTL Loads
- TTL NMOS Compatible Input Levels
- Outputs Directly Interface to CMOS, NMOS and TTL
- Operating Voltage Range: 4.5 to 5.5 V
- Low Input Current: 1.0 μ A
- In Compliance with the Requirements Defined by JEDEC Standard No. 7A
- Chip Complexity: 178 FETs or 44.5 Equivalent Gates

LOGIC DIAGRAM

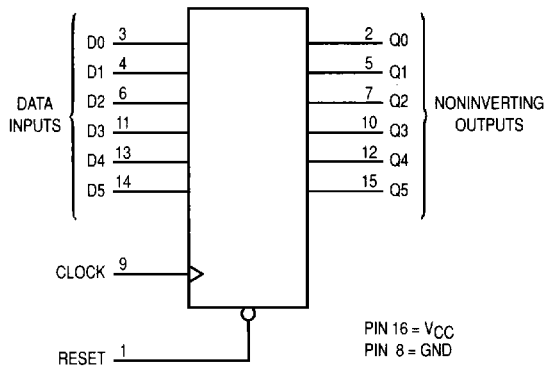

Design Criteria	Value	Units
Internal Gate Count*	44.5	ea.
Internal Gate Propagation Delay	1.5	ns
Internal Gate Power Dissipation	0.005	μ W
Speed Power Product	0.0075	pJ

* Equivalent to a two-input NAND gate.

MC74HCT174A

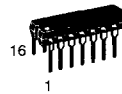

N SUFFIX
PLASTIC PACKAGE
CASE 648-08



D SUFFIX
SOIC PACKAGE
CASE 751B-05

ORDERING INFORMATION

MC74HCXXXAN Plastic
MC74HCXXXAD SOIC

PIN ASSIGNMENT

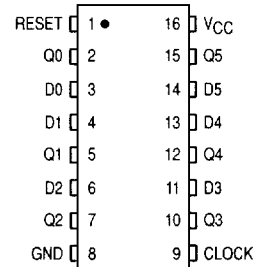

FUNCTION TABLE

Inputs			Output
Reset	Clock	D	Q
L	X	X	L
H	\nearrow	H	H
H	\nearrow	L	L
H	L	X	No Change
H	\searrow	X	No Change



MAXIMUM RATINGS*

Symbol	Parameter	Value	Unit
V_{CC}	DC Supply Voltage (Referenced to GND)	- 0.5 to + 7.0	V
V_{in}	DC Input Voltage (Referenced to GND)	- 1.5 to $V_{CC} + 1.5$	V
V_{out}	DC Output Voltage (Referenced to GND)	- 0.5 to $V_{CC} + 0.5$	V
I_{in}	DC Input Current, per Pin	± 20	mA
I_{out}	DC Output Current, per Pin	± 25	mA
I_{CC}	DC Supply Current, V_{CC} and GND Pins	± 50	mA
P_D	Power Dissipation in Still Air Plastic DIP† SOIC Package†	750 500	mW
T_{stg}	Storage Temperature	- 65 to + 150	°C
T_L	Lead Temperature, 1 mm from Case for 10 Seconds (Plastic DIP or SOIC Package)	260	°C

* Maximum Ratings are those values beyond which damage to the device may occur. Functional operation should be restricted to the Recommended Operating Conditions.

† Derating — Plastic DIP: - 10 mW/°C from 65° to 125°C
SOIC Package: - 7 mW/°C from 65° to 125°C

For high frequency or heavy load considerations, see Chapter 2.

This device contains protection circuitry to guard against damage due to high static voltages or electric fields. However, precautions must be taken to avoid applications of any voltage higher than maximum rated voltages to this high-impedance circuit. For proper operation, V_{in} and V_{out} should be constrained to the range $GND \leq (V_{in} \text{ or } V_{out}) \leq V_{CC}$. Unused inputs must always be tied to an appropriate logic voltage level (e.g., either GND or V_{CC}). Unused outputs must be left open.

RECOMMENDED OPERATING CONDITIONS

Symbol	Parameter	Min	Max	Unit
V_{CC}	DC Supply Voltage (Referenced to GND)	4.5	5.5	V
V_{in}, V_{out}	DC Input Voltage, Output Voltage (Referenced to GND)	0	V_{CC}	V
T_A	Operating Temperature, All Package Types	- 55	+ 125	°C
t_r, t_f	Input Rise and Fall Time (Figure 1)	0	500	ns

3

DC ELECTRICAL CHARACTERISTICS (Voltages Referenced to GND)

Symbol	Parameter	Test Conditions	V_{CC} V	Guaranteed Limit			Unit
				- 55 to 25°C	85°C	125°C	
V_{IH}	Minimum High-Level Input Voltage	$V_{out} = 0.1 \text{ or } V_{CC} - 0.1 \text{ V}$ $ I_{out} \leq 20 \mu\text{A}$	4.5	2.0	2.0	2.0	V
			5.5	2.0	2.0	2.0	
V_{IL}	Maximum Low-Level Input Voltage	$V_{out} = 0.1 \text{ or } V_{CC} - 0.1 \text{ V}$ $ I_{out} \leq 20 \mu\text{A}$	4.5	0.8	0.8	0.8	V
			5.5	0.8	0.8	0.8	
V_{OH}	Minimum High-Level Output Voltage	$V_{in} = V_{IH} \text{ or } V_{IL}$ $ I_{out} \leq 20 \mu\text{A}$	4.5	4.4	4.4	4.4	V
			5.5	5.4	5.4	5.4	
V_{OL}	Maximum Low-Level Output Voltage	$V_{in} = V_{IH} \text{ or } V_{IL}$ $ I_{out} \leq 4.0 \text{ mA}$	4.5	3.98	3.84	3.70	V
			5.5	0.1	0.1	0.1	
V_{OL}	Maximum Low-Level Output Voltage	$V_{in} = V_{IH} \text{ or } V_{IL}$ $ I_{out} \leq 20 \mu\text{A}$	4.5	0.1	0.1	0.1	V
			5.5	0.1	0.1	0.1	
V_{OL}	Maximum Low-Level Output Voltage	$V_{in} = V_{IH} \text{ or } V_{IL}$ $ I_{out} \leq 4.0 \text{ mA}$	4.5	0.26	0.33	0.4	V
			5.5	0.26	0.33	0.4	
I_{in}	Maximum Input Leakage Current	$V_{in} = V_{CC} \text{ or } GND$	5.5	± 0.1	± 1.0	± 1.0	μA
I_{CC}	Maximum Quiescent Supply Current (per Package)	$V_{in} = V_{CC} \text{ or } GND$ $I_{out} = 0 \mu\text{A}$	5.5	4.0	40	160	μA
ΔI_{CC}	Additional Quiescent Supply Current	$V_{in} = 2.4 \text{ V}$, Any One Input $V_{in} = V_{CC} \text{ or } GND$, Other Inputs $I_{out} = 0 \mu\text{A}$	5.5	≥ - 55°C	25°C to 125°C		mA
				2.9	2.4		

NOTE: Information on typical parametric values can be found in Chapter 2.

AC ELECTRICAL CHARACTERISTICS ($V_{CC} = 5.0\text{ V} \pm 10\%$, $C_L = 50\text{ pF}$, Input $t_r = t_f = 6.0\text{ ns}$)

Symbol	Parameter	Guaranteed Limit			Unit
		- 55 to 25°C	≤ 85°C	≤ 125°C	
f_{MAX}	Maximum Clock Frequency (50% Duty Cycle)	30	24	20	MHz
t_{PLH} , t_{PHL}	Maximum Propagation Delay, Clock to Q (Figures 1 and 4)	24	30	36	ns
t_{PHL}	Maximum Propagation Delay, Reset to Q (Figures 2 and 4)	23	28	35	ns
t_{TLH} , t_{THL}	Maximum Output Transition Time, Any Output (Figures 1 and 4)	15	19	22	ns
C_{in}	Maximum Input Capacitance	10	10	10	pF

NOTE: For propagation delays with loads other than 50 pF, and information on typical parametric values, see Chapter 2.

C_{PD}	Power Dissipation Capacitance (Per Enabled Output)*	Typical @ 25°C, $V_{CC} = 5.0\text{ V}$		pF
		79		

* Used to determine the no-load dynamic power consumption: $P_D = C_{PD} V_{CC}^2 f + I_{CC} V_{CC}$. For load considerations, see Chapter 2.

TIMING REQUIREMENTS ($V_{CC} = 5.0\text{ V} \pm 10\%$, $C_L = 50\text{ pF}$, Input $t_r = t_f = 6.0\text{ ns}$)

Symbol	Parameter	Fig.	Guaranteed Limit						Unit
			- 55 to 25°C		≤ 85°C		≤ 125°C		
			Min	Max	Min	Max	Min	Max	
t_{su}	Minimum Setup Time, Data to Clock	3	10		13		15		ns
t_h	Minimum Hold Time, Clock to Data	3	5.0		6.0		8.0		ns
t_{rec}	Minimum Recovery Time, Reset Inactive to Clock	2	5.0		6.0		8.0		ns
t_w	Minimum Pulse Width, Clock	1	15		19		22		ns
t_w	Minimum Pulse Width, Reset	2	15		19		22		ns
t_r , t_f	Maximum Input Rise and Fall Times	1		500		500		500	ns

3

SWITCHING WAVEFORMS

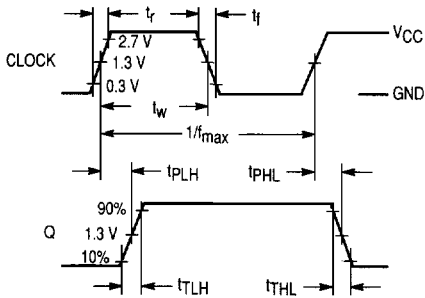

Figure 1.

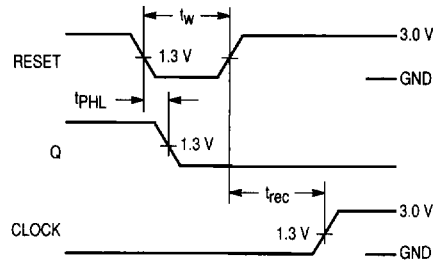

Figure 2.

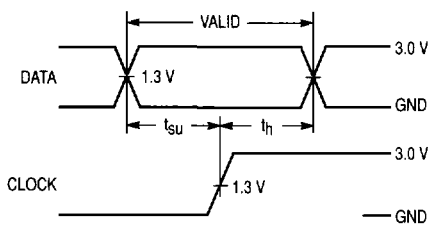
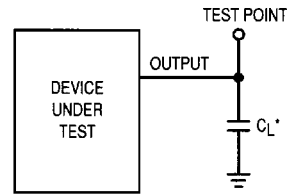

Figure 3.



* Includes all probe and jig capacitance

Figure 4. Test Circuit

3

EXPANDED LOGIC DIAGRAM

