

## Overview

As microelectronic equipment has been adopted more and more in the electronic industry, electronic circuits are being converted to those of the unit type, modular type and integrated type. Foreseeing this trend, our company made use of the latest technology of high-frequency connectors and developed the ultrasmall high-frequency connectors of the MSS (micro-slide-snap) series. (Registered Utility Model Nos. 882197 and 923632)

- MSS is approved in the Defense Agency's standards NDS XC 6120 and DSP C6206.
- MSS displays its individuality in all respects. Although the connectors have been highly miniaturized in their size, they have performance properties which fully rival those of medium-sized high-frequency connectors. Since the slide-snap lock system is adopted, more or less perfect surface contacts are achieved in both the inner and outer conductors, while at the same time superior vibration-resistance properties are displayed.
- Two types of MSS are available: the solderless connecting system, in which the simplicity and accuracy of the work of connecting the wiring is greatly increased; and the screw-clamp system, which makes it possible to connect the wiring accurately.
- The MSS types match mainly the 1.5D-2V and 2.5D-2V cables. The MSS1 type was developed for RG-55/U cables. It is the same as the MSS types in its shapes, materials and performance characteristics. However, please note that it is one size larger than the MSS types and hence is not interchangeable with the MSS types.
- The types for printed circuit boards are constructed so as to be mountable by soldering directly onto the printed circuit boards.

## Materials, finish

Parts	Materials	Finish
Shell	Brass	Gold plating
Male contact	Brass	Gold plating
Female contact	Beryllium copper	Gold plating
Insulation	Tetrafluoride resin	
Lock spring	Beryllium copper	Nickel plating

## Main performance characteristics

Items	Standard value
Contact resistance	5mΩ or less (at 1A DC)
Insulation resistance	2000MΩ or more at 500V DC
Withstand voltage	500V AC (rms) for 1 minute
Characteristic impedance	50Ω
Voltage standing wave ratio	1.2 or less at DC ~ 2000MHz

## MSS-P plugs



MSS-P-2.5

Part No.	Applicable cables	$d_1 \phi$	$d_2 \phi$	$d_3 \phi$	L	Remarks
*MSS-P-1.5	1.5D-2V, RG-174/U	4.65	7.5	1.8	20.5	Fig. 1
*MSS-P-2.5	2.5D-2V	4.65	7.5	2.8	20.5	Fig. 1
MSS1-P-55/U	RG-55/U	5.65	8.5	3.2	24.0	Fig. 1
*MSS-P-1.5-A	1.5D-2V	4.65	6.5	3.4	16.0	Fig. 2
MSS-P-196/U	RG-196/U	4.65	6.5	1.9	16.0	Fig. 2

\*Standard product

Fig. 1

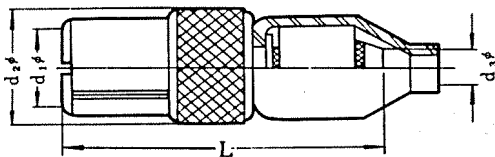
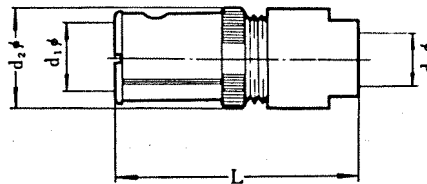

Fig. 2



## MSS-R receptacles



MSS-R

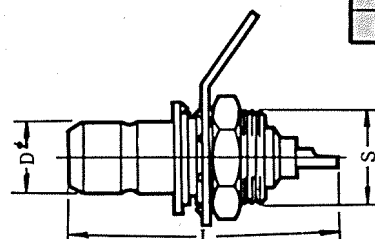
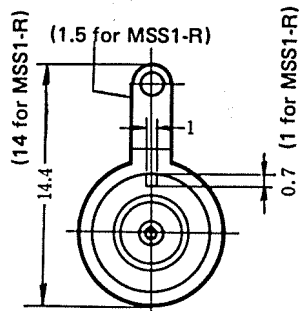

Part No.	Dφ	L	S
*MSS-R	4.6	17.9	M6x0.75
MSS1-R	5.6	19.8	M6x0.5

\*Standard product

## MSS-J jacks



MSS-J-2.5

Part No.	Applicable cables	d $\phi$	L
*MSS-J-1.5	1.5D-2V, RG-174/U	1.8	20.6
MSS-J-2.5	2.5D-2V	2.8	20.6

\*Standard product

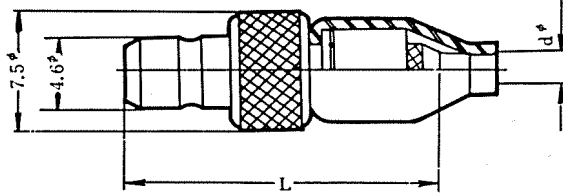

## MSS-PJ panel jacks



MSS-PJ-2.5

Part No.	Applicable cables	d <sub>1</sub> $\phi$	d <sub>2</sub> $\phi$	S	a	L
MSS-PJ-2.5	2.5D-2V	4.6	2.8	M6x0.75	7.5	20.4
MSS1-PJ-55/U	RG-55/U	5.6	3.2	M7x0.75	9.0	23.2

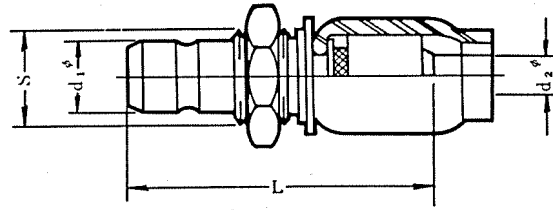
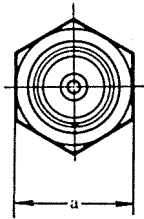

## MSS-LP L-type plugs

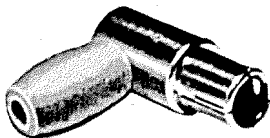

MSS-LP-2.5

Part No.	Applicable cables	d <sub>1</sub> $\phi$	d <sub>2</sub> $\phi$	ℓ <sub>1</sub>	ℓ <sub>2</sub>	Remarks
*MSS-LP-1.5	1.5D-2V, RG-174/U	1.8	4.65	19.0	15.5	Fig. 3
*MSS-LP-2.5	2.5D-2V	2.8	4.65	19.0	15.5	Fig. 3
MSS1-LP-55/U	RG-55/U	3.2	5.65	19.5	16.5	Fig. 3
*MSS-LP-1.5-A	1.5D-2V	3.4	4.85	15.0	15.5	Fig. 4
MSS-LP-196/U	RG-196/U	2.3	4.65	15.0	15.5	Fig. 4

\*Standard products

Fig. 3

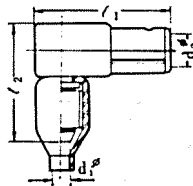
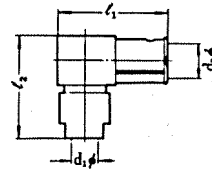

Fig. 4



## MSS-A linear adapters



MSS-A-JJ

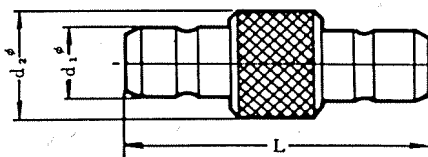

Part No.	d <sub>1</sub> $\phi$	d <sub>2</sub> $\phi$	L
MSS-A-JJ	4.6	7	19

# MSS SERIES

# RF CO-AXIAL CONNECTORS

## Receptacle (Types for mounting printed circuit boards)

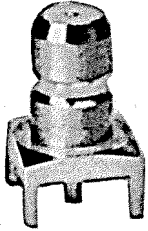

MSS-R-PC

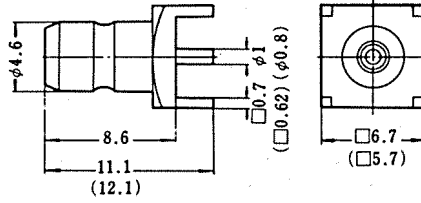

HRS No.	Part No.	Remarks
* CL319-0034-1	MSS-R-PC	<input type="checkbox"/> 6.7
CL319-0055-1	MSS-R-PC-3	<input type="checkbox"/> 5.7

\* Standard product

## L-type receptacle (Types for mounting printed circuit boards)

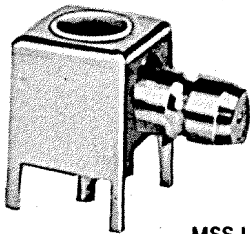

MSS-LR-PC

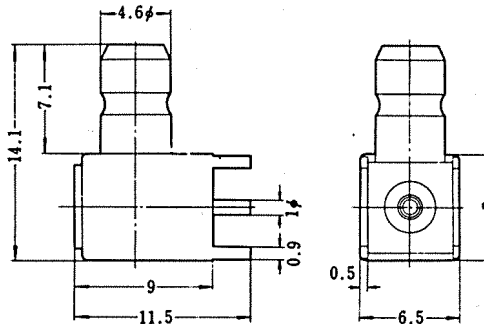

Part No.
MSS-LR-PC

## T-type receptacle (Types for mounting printed circuit boards)

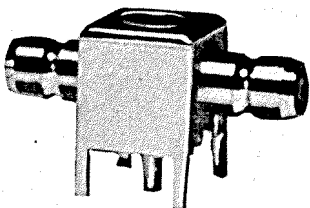

MSS-TR-PC

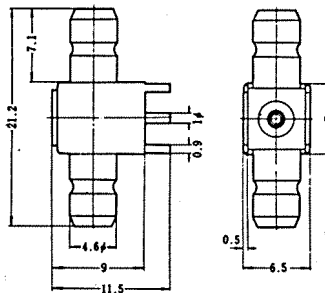

Part No.
MSS-TR-PC

## Four-way branched receptacle (Types for mounting printed circuit boards)

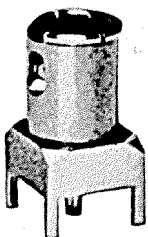

MSS-PR-PC

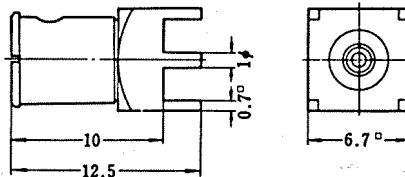

Part No.
MSS-PR-PC

# MSS SERIES RF CO-AXIAL CONNECTORS

## Connecting methods

### Solderless Connecting system

Part No.	A	B
MSS-P-1.5	5.8	2.6
MSS-P-2.5	5.8	1.7
MSS-J-1.5	7.4	3.3
MSS-LP-1.5	5.8	2.0

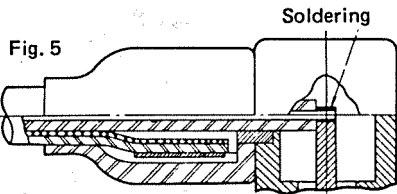
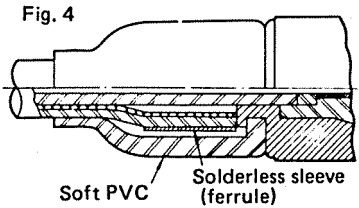
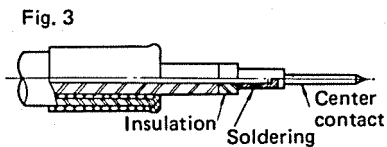
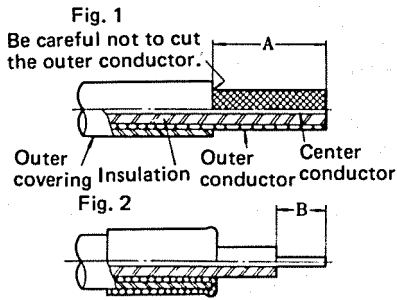

1. Cut the outer covering as shown in the drawing on the left.
2. Insert the soft PVC and ferrule, in that order, onto the cable. Fold back the outer conductor, and cut the insulator to obtain the dimensions indicated in B.
3. Insert the insulation into the center conductor of the cable. Next insert the center conductor into the center contact and solder it. (Be careful to avoid any solder build-up.)
4. Insert this block into the plug. Insert the solderless sleeve, and Crimp it with the proper tool. Cut off any of the outer conductor which is left outside the ferrule at that time.\*1
5. Finally, insert the soft PVC.
6. In MSS-LP-1.5, after everything has been done up to Fig. 2, insert into the plug and then perform 4 and 5.
7. Put the cable core into the split part of the center contact and solder it. (Be careful to avoid any solder build-up.)

\*1 Tool recommended: UM-MSS-T-1

### Clamping system

Part No.	A	B	C
MSS-P-1.5-A	4.0	2.0	0.7
MSS-LP-1.5-A	7.1	1.5	5.3

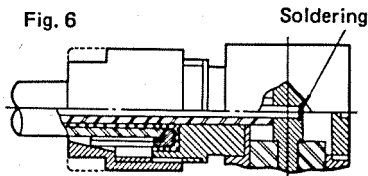
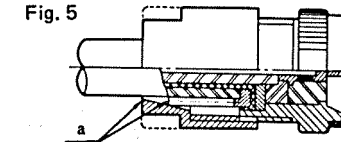
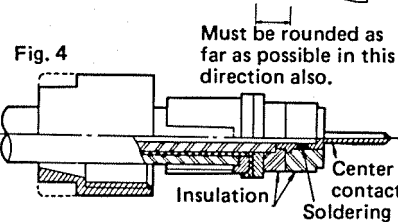
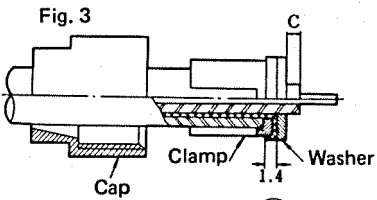
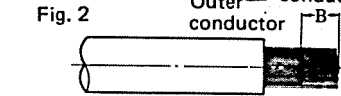
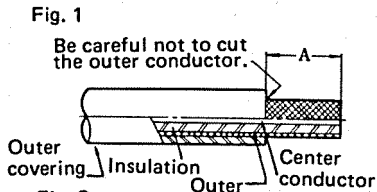

1. Cut the outer covering as shown in the drawing on the left.
2. Disentangle the outer conductor, and cut the insulation at dimension B.
3. Pass the cable through the cap, insert the clamp, and fold back the outer conductor as is shown in the drawing on the left. Cut the outer conductor at 1.4mm after inserting the washer. (The C dimensions are approximately the dimensions given in the table above.) (Tighten the clamp in the direction of the split.)
4. Insert the insulation in front of the washer, insert the center contact into the core of the cable, and solder it. (Be careful to avoid any solder build-up.)
5. Insert the insulation.
6. Insert this block into the plug and tighten the cap until they match at part "a".
7. In MSS-LP-1.5-A, after everything has been done up to Fig. 3, insert into the plug and then tighten the cap thoroughly.
8. Put the cable core into the hole in the center contact and solder it. (Be careful to avoid any solder build-up.)

## Drawings of holes drilled for panel mounting

### Mounting holes for MSS-R, MSS-PJ-2.5

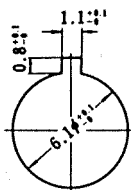

### Mounting holes for MSS1-R

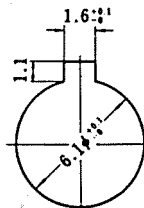

### For printed circuit boards

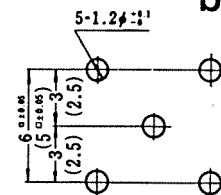

MSS-R-PC, MSS-PR-PC, MSS-LR-PC  
Note: MSS-R-PC-3 are also available with the dimensions given in parenthesis.