

Compact, 16-Point Output Blocks Save Space in Control Panels

- Compact standard version or quick-to-service vertical models
- Power MOSFET or relays installed
- Built-in diode absorbs coil surge
- All have operation indicators
- Terminal blocks accept M3.5 fork-type crimp terminals
- Expansion terminal block for vertical models allows power line connections
- Mounts to DIN rail track or with screws
- Dedicated cables for high-density PLC modules available (sold separately)



Ordering Information

■ RELAY OUTPUT BLOCKS

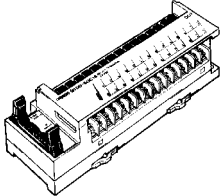
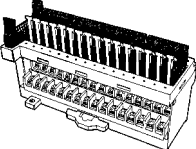
Appearance	Output points	Rated voltage	Output type	Internal I/O circuit common	Part number
	16 points (SPST-NO x 16) includes relay pulling tool.	24 VDC	Relay outputs	NPN (+ common)	G70D-SOC16 DC24
				PNP (- common)	G70D-SOC16-1 DC24
			Power MOSFET relay outputs	NPN (+ common)	G70D-FOM16
				PNP (- common)	G70D-FOM16-1 DC24
	16 points (SPST-NO x 16)	24 VDC	Relay outputs	NPN (+ common)	G70D-VSOC16
			Power MOSFET relay outputs	NPN (+ common)	G70D-VFOM16

■ GENERAL-PURPOSE CONNECTING CABLES

The following cables can be connected to I/O boards and PLC modules from any manufacturer.

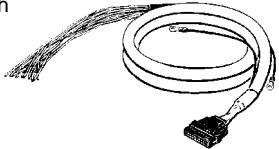
Item	Length	Part number
Connecting cable with crimp hook terminals 	1 m (3.28 ft)	G79-Y100C
	1.5 m (4.92 ft)	G79-Y150C
	2 m (6.56 ft)	G79-Y200C
	3 m (9.84 ft)	G79-Y300C
	5 m (16.40 ft)	G79-Y500C
Connecting cable with loose wires 	2 m (6.56 ft)	G79-A200C
	5 m (16.40 ft)	G79-A500C

■ DEDICATED CONNECTING CABLES FOR OMRON PLC MODULES

The following cables are designed to connect directly to Omron PLC modules and have dedicated connectors for specific models.

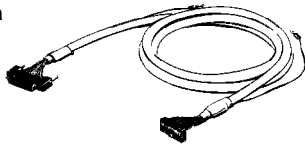
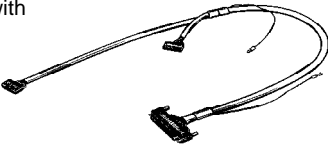
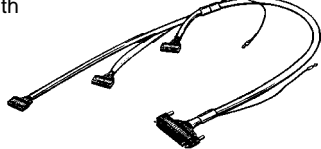
Item	Length	Part number
Connecting cable with one connector for high-density I/O modules 	1 m (3.28 ft)	G79-100C
	1.5 m (4.92 ft)	G79-150C
	2 m (6.56 ft)	G79-200C
	3 m (9.84 ft)	G79-300C
	5 m (16.40 ft)	G79-500C
Connecting cable with two connectors for high-density I/O modules 	1 m (3.28 ft) + 0.75 m (2.46 ft)	G79-O100C-75
	2 m (6.56 ft) + 1.75 m (5.74 ft)	G79-O200C-175
	3 m (9.84 ft) + 2.75 m (9.02 ft)	G79-O300C-275
	5 m (16.40 ft) + 4.75 m (15.58 ft)	G79-O500C-475
Connecting cable with three connectors for CS1 high-density I/O modules 	1.5 m (4.92 ft) + 1.25 m (4.10 ft) + 1 m (3.28 ft)	G79-150C-125-100
	2 m (6.56 ft) + 1.75 m (5.74 ft) + 1.5 m (4.92 ft)	G79-200C-175-150
	3 m (9.84 ft) + 2.75 m (9.02 ft) + 2.5 m (8.20 ft)	G79-300C-275-250

■ ACCESSORIES

Item	Applicable output blocks	Rated voltage	Part number
Shorting bar	G70D-VSOC16, G70D-VFOM16	—	G6D-4-SB
Expansion terminal block	G70D-VSOC16, G70D-VFOM16	—	G70D-ET
Replacement relays	G70D-VSOC16, G70D-SOC16	24 VDC; minimum load 10 mA at 5 VDC	G6D-1A DC24
	G70D-VFOM16, G70D-FOM16	24 VDC	G3DZ-2R6PL DC24

Specifications

■ RATINGS

The following values apply to the G6D Relay mounted to the G70D and do not apply to the G6D Relay itself before it is mounted.

Electromechanical Relay (G6D) Specifications

Coil Ratings

Rated voltage	24 VDC
Rated current	10.5 mA
Coil resistance	2,880 Ω
Must operate voltage	70% max. of rated voltage
Release voltage	10% min. of rated voltage
Max. allowable voltage	130% of rated voltage
Power consumption	Approx. 200 mW

- Note: 1. The must operate voltage is 75% max. of the rated voltage if the Relay is mounted upside down.
 2. Rated current and coil resistance were measured at a coil temperature of 23°C (73.4°F) with a tolerance of $\pm 10\%$.
 3. Operating characteristics were measured at a coil temperature of 23°C (73.4°F).
 4. The maximum allowable voltage is the maximum value of the allowable voltage range for the relay coil operating power supply. There is no continuous allowance.
 5. The rated current includes the current consumption of the operation indicator.

Contact Ratings

Load	Resistive load ($\cos\phi = 1$)
Rated load	3 A at 250 VAC, 3 A at 30 VDC
Rated carry current	5 A (See Note 1)
Max. switching voltage	250 VAC, 30 VDC
Max. switching current	5 A
Max. switching capacity	1,250 VA, 150 W
Error rate (level p) (reference value) (see note 2)	5 VDC, 1 mA
Life expectancy	Electrical: 100,000 operations min. (under and at the rated load at 1,800 operations/hr) Mechanical: 20,000,000 operations min. (at 18,000 operations/hr)

- Note: 1. This value is for when the maximum 8 points are ON.
 2. This value is for a switching frequency of 120 times per minute.

Power MOSFET Relay (G3DZ) Specifications

The following values apply to the G3DZ Relay mounted to the G70D and do not apply to the G3DZ Relay itself before it is mounted.

Input Ratings

Rated voltage	24 VDC	
Operating voltage	19.2 to 28.8 VDC	
Voltage level	Must operate	19.2 VDC max.
	Must release	1 VDC min.
Input impedance	4 k Ω $\pm 20\%$	
Rated current	8.2 mA $\pm 20\%$	

Note: The rated current includes the current consumption of the operation indicator.

Output Ratings

Load voltage	3 to 264 VAC, 3 to 125 VDC
Load current	100 μ A to 0.3 A
Inrush current	6 A (10 ms)

■ CHARACTERISTICS

Part number		G70D-VSOC16/ G70D-SOC16 (-1)	G70D-SOC16(-1)	G70D-VFOM16/ G70D-FOM16 (-1)	G70D-FOM16 (-1)
Output type		Relay outputs		Power MOSFET Relay outputs	
Contact form		16 points (SPST-NO x 16)			
Contact mechanism		Single		—	
Contact resistance		100 mΩ max. measured at 1 A, 5 VDC			
Insulation method		—		Photocoupler	
Must operate time		10 ms max. at 23°C (73.4°F) ambient temperature		6 ms max.	
Release time		10 ms max. at 23°C (73.4°F) ambient temperature		10 ms max.	
Output ON-resistance		—		2.4 Ω max.	
Leakage current at OFF-state		—		10 μA max. at 125 VDC	
Max. switching frequency		Mechanical: 18,000 operations/hr Rated load: 1,800 operations/hr		—	
Insulation resistance		100 MΩ min. (at 500 VDC)			
Dielectric strength		2,000 VAC for 1 min between coil and contact		2,000 VAC for 1 min between input and output terminals	
Noise immunity		Power input (normal mode): 600 V for 10 min with a pulse width of 100 ns/1 μs Power input (common mode): 1.5 kV for 10 min with a pulse width of 100 ns/1 μs Input cable (coiling): 1.5 kV for 10 min with a pulse width of 100 ns/1 μs Unit body (coiling): 600 V for 10 min with a pulse width of 100 ns/1 μs			
Vibration resistance	Destruction	10 to 55 Hz, 1.0-mm double amplitude for 2 hrs each in X, Y, and Z directions			
	Malfunction	10 to 55 Hz, 0.75-mm double amplitude for 2 hrs each in X, Y, and Z directions			
Shock resistance	Destruction	300 m/s ²			
	Malfunction	100 m/s ²			
Operating voltage range		24 VDC +10%/-15%			
Current consumption		Approx. 170 mA at 24 VDC (See Note 2)	Approx. 300 mA at 24 VDC (See Note 2)	Approx. 125 mA at 24 VDC (See Note 3)	Approx. 300 mA at 24 VDC (See Note 3)
Cable length		Between block and controller: 5 m max. (reference value for AWG28) Between block and external device: Dependent on load			
LED color		Operation indicator: orange	Operation indicator: orange Power supply: green	Operation indicator: orange	Operation indicator: orange Power supply: green
Coil surge absorber		Diode (600 V, 1 A)	Diode (400 V, 0.3 A)	Diode (600 V, 1 A)	Diode (400 V, 0.3 A)
Ambient temperature	Operating	-25°C to 55°C (-13°F to 131°F) with no icing or condensation	0°C to 55°C (32°F to 131°F) with no icing or condensation	-25°C to 55°C (-13°F to 131°F) with no icing or condensation	0°C to 55°C (32°F to 131°F) with no icing or condensation
	Storage	-25°C to 65°C (-13°F to 149°F) with no icing or condensation	-20°C to 65°C (-4°F to 149°F) with no icing or condensation	-25°C to 65°C (-13°F to 149°F) with no icing or condensation	-20°C to 65°C (-4°F to 149°F) with no icing or condensation
Ambient humidity	Operating	45% to 85% RH	35% to 85% RH	45% to 85% RH	35% to 85% RH
Mounting strength		No damage when 49 N pull load was applied for 1 s in all directions (except for 9.8 N min. in direction of rail)			
Terminal strength		Tightening torque: 0.78 to 1.18 N • m Pull strength: 49 N for 1 min			
Weight (See Note 4)		Approx. 280 g	Approx. 200 g	Approx. 280 g	Approx. 200 g

Note: 1. The above values are initial values.

2. Current consumption is when all points are ON and includes G6D Relay coil current but does not include any external load current.

3. Current consumption is when all points are ON and includes G3DZ input current but does not include any external load current.

4. The Relay Output Block weighs approximately 315 g with the Expansion Terminal Block mounted.

Engineering Data

■ RELAY OUTPUT MODELS

G70D-SOC16(-1)/G70D-VSOC16

Max. Switching Capacity

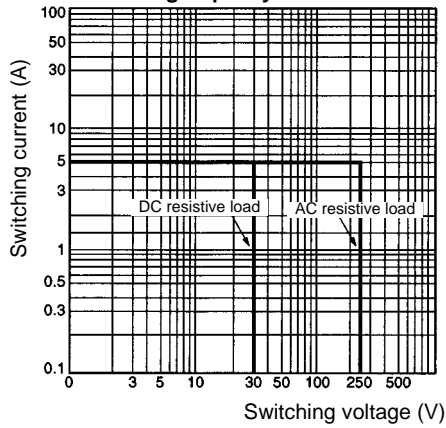

Life Expectancy

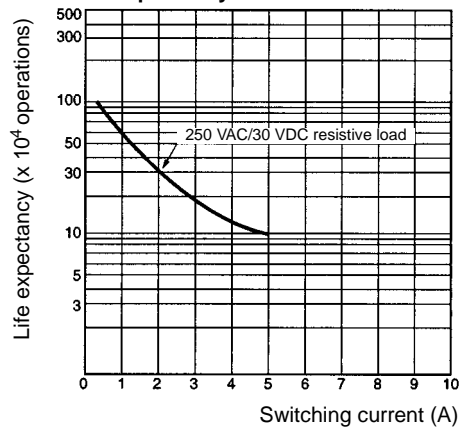

■ POWER MOSFET OUTPUT MODELS

G70D-FOM16(-1)/G70D-VFOM16

Load Current vs. Ambient Temperature Characteristics

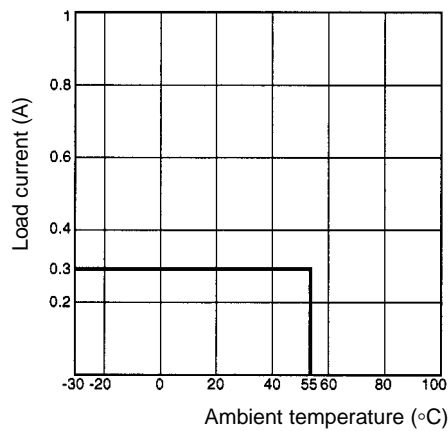

Inrush Current Resistivity

Non-repetitive (Keep the inrush current to half the rated value or less if it occurs repeatedly.)

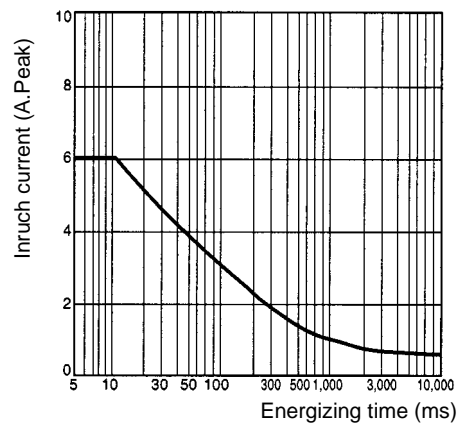

Operation

INTERNAL CIRCUIT

G70D-SOC16/G70D-FOM16

NPN-compatible output terminal (+ common output): A controller with an NPN transistor (- common output) can be connected.

Connector Terminal Arrangement (Top View)

I/O indications on Screw Terminals

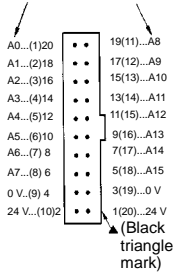

Connector pin numbers in parentheses are for G79 Cable.
Note: The pin numbers are indicated for user's convenience. The black triangle mark can be used to determine orientation.

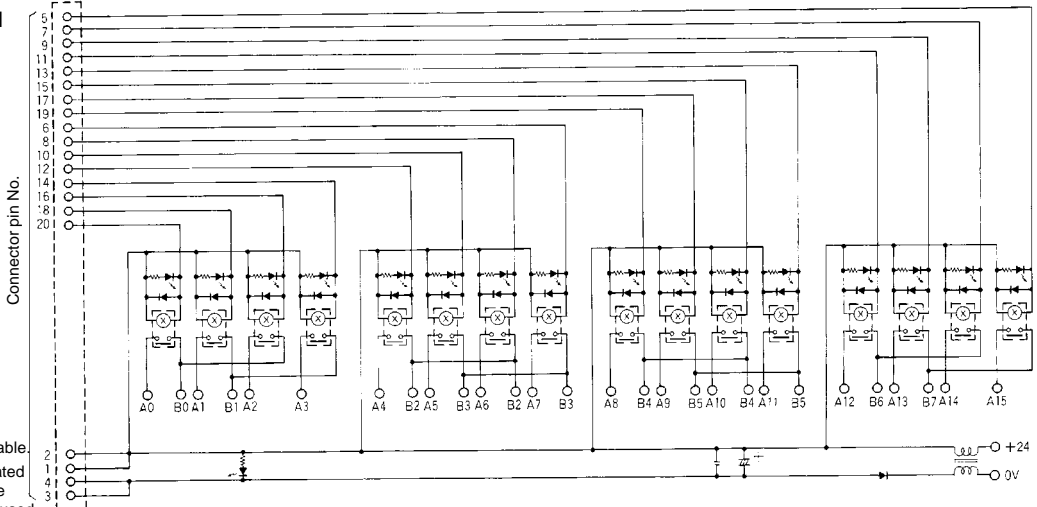

Note: Wiring shown above is for G6D Power Relays.

G70D-SOC16-1/G70D-FOM16-1

PNP-compatible output terminal (- common output): A controller with a PNP transistor (+ common output) can be connected.

Connector Terminal Arrangement (Top View)

I/O indications on Screw Terminals

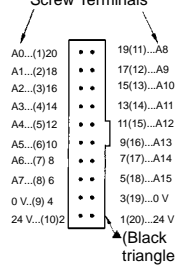

Connector pin numbers in parentheses are for G79 Cable.
Note: The pin numbers are indicated for user's convenience. The black triangle mark can be used to determine orientation.

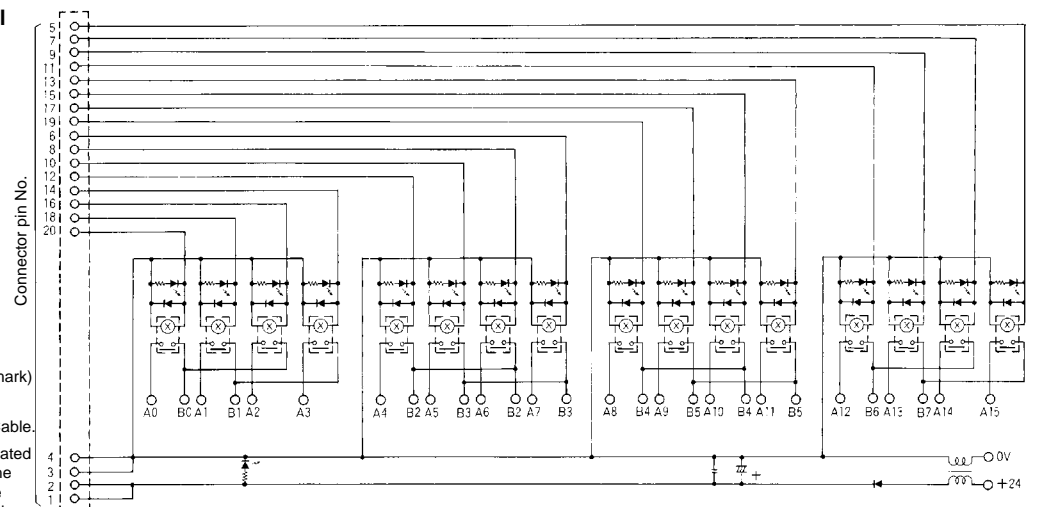

Note: Wiring shown above is for G6D Power Relays.

G70D-VSOC16/G70D-VFOM16

NPN-compatible output terminal (+ common output): A controller with an NPN transistor (- common output) can be connected.

Connector Terminal Arrangement (Top View)

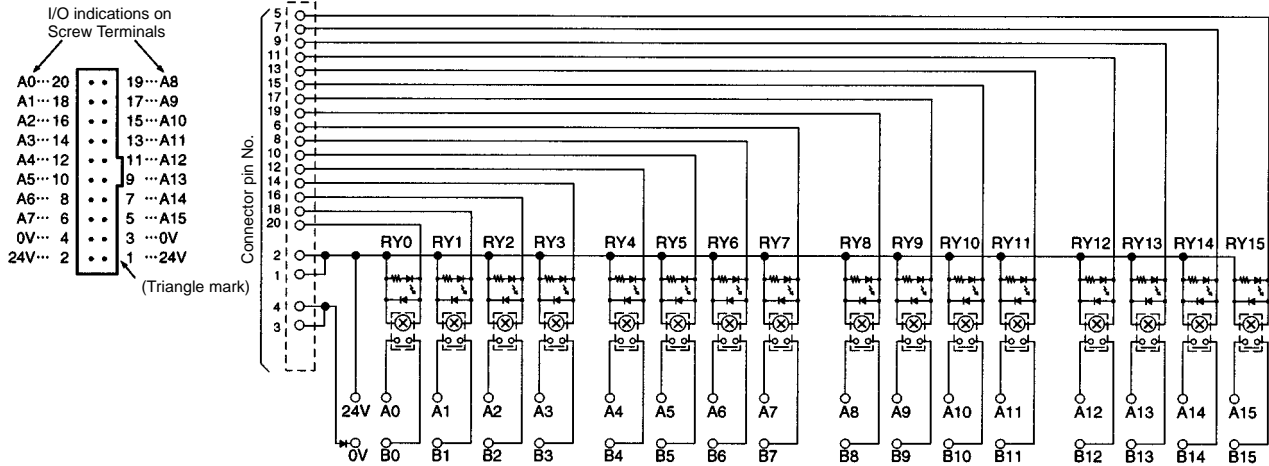

With Expansion Terminal Block



- Note: 1. The terminal block shows the G70D-VSOC16, which operates with G6D relays mounted. The G70D-VFOM16 terminal block uses G3DZ power MOSFET relays in place of G6D relays.
2. Terminals C0 to C15 are electrically independent from each other.
3. When the terminal block and relay block are connected to each other, each electrical check terminal of the relay block is connected to the corresponding terminal of the terminal block.

■ TERMINAL ARRANGEMENT AND LOAD CONNECTION EXAMPLES

G70D-SOC16(-1)/G70D-FOM16(-1)

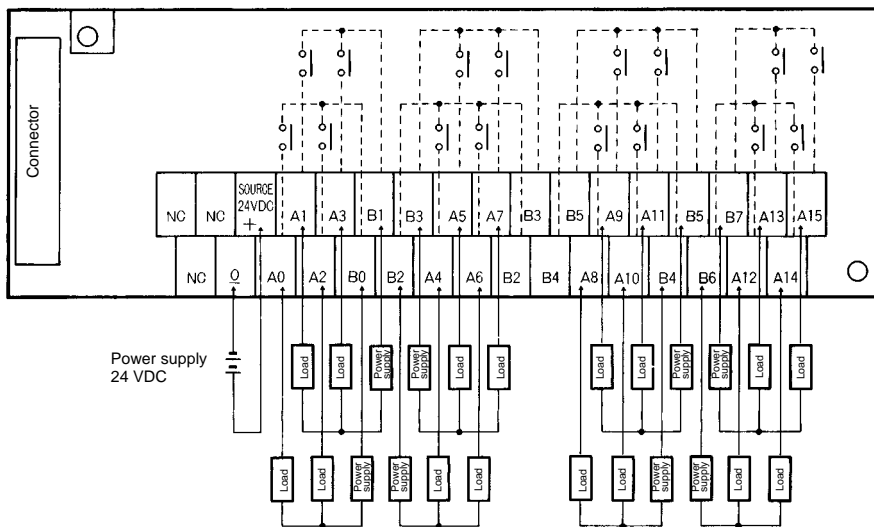

- Note: 1. Dotted lines show internal connections.
2. B2, B3, B4, and B5 are each found in two locations. Connect power to either of them.

G70D-VSOC16/VFOM16 Without Expansion Terminal Block

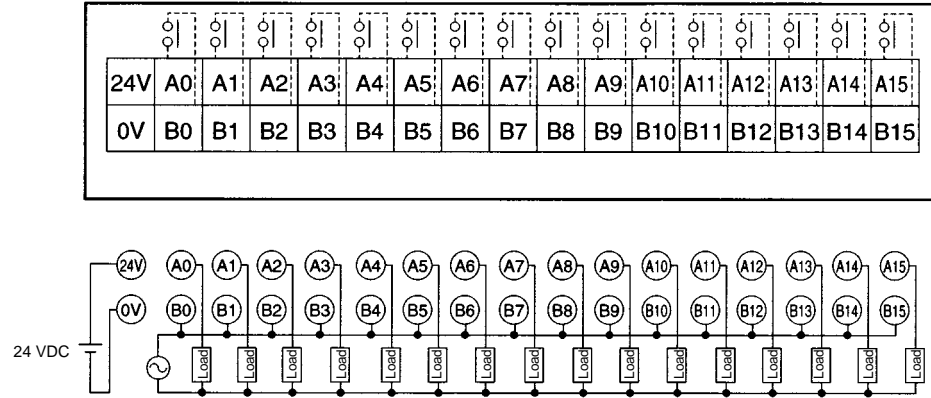

G70D-VSOC16/VFOM16 With Expansion Terminal Block

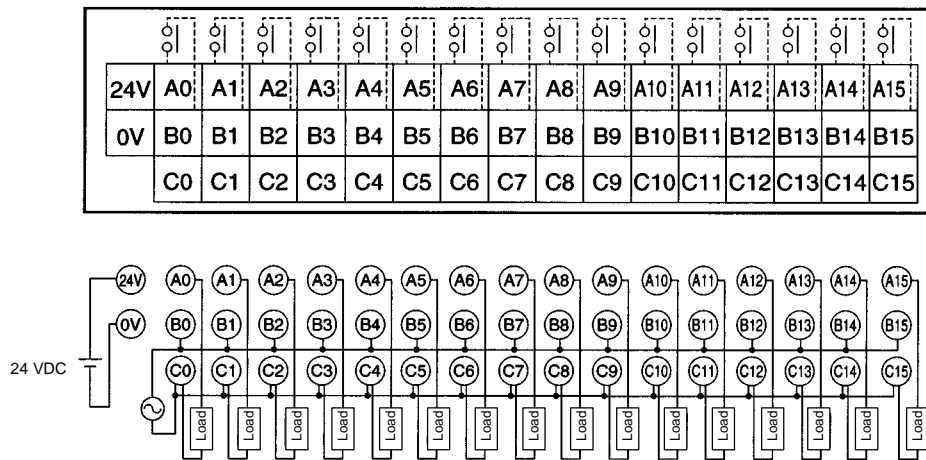

Electrical check terminals (See Note)

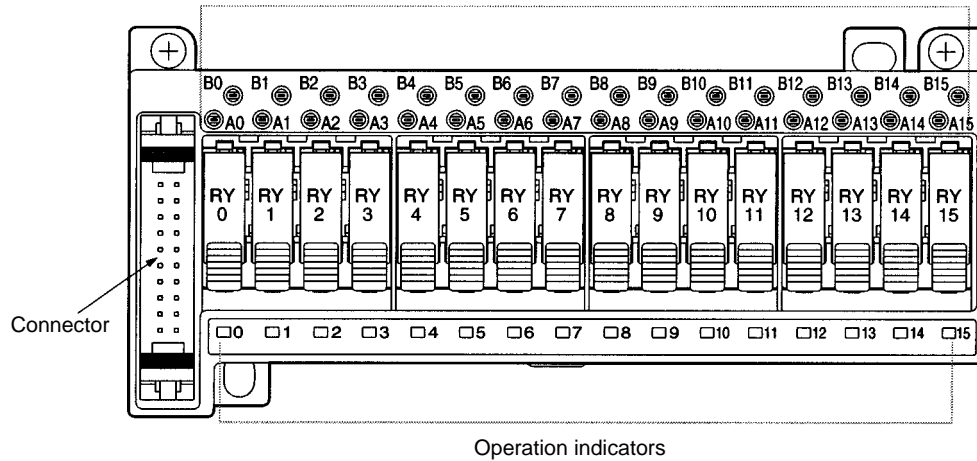

Note: When the terminal block and relay block are connected to each other, each electrical check terminal of the relay block is connected to the corresponding terminal of the terminal block.

Dimensions

Unit: mm (inch)

G70D-SOC16(-1) G70D-FOM16(-1)

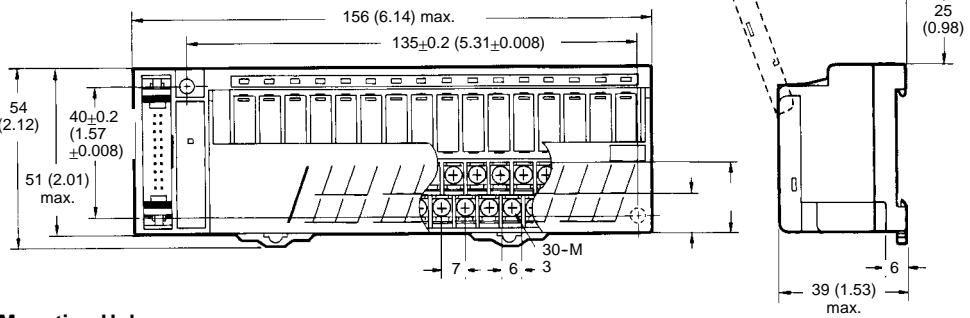
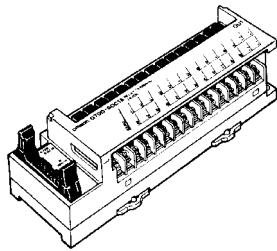

Mounting Holes

Two, 4.2 dia. or M4

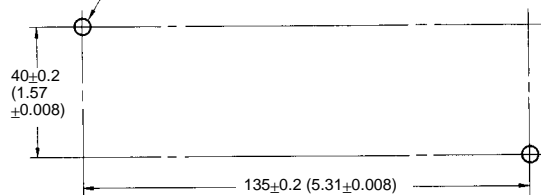

G70D-VSOC16 G70D-VFOM16

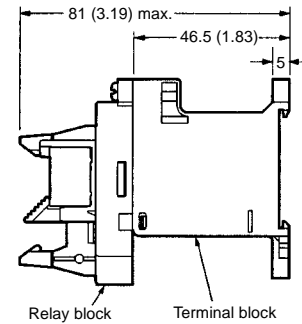
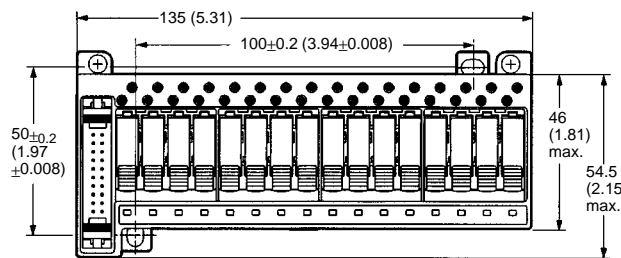
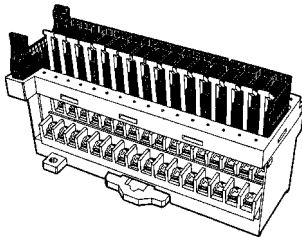

Relay block Terminal block

Terminal Block (without Expansion Terminal Block)

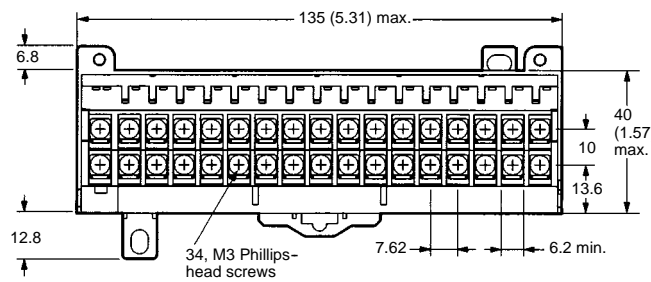

Terminal Block (with Expansion Terminal Block)

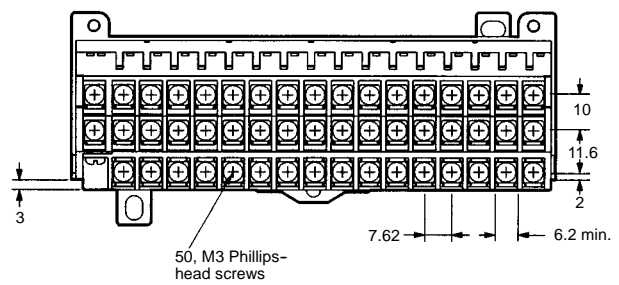

Mounting Holes

Two, 4.2 dia. or M4 holes

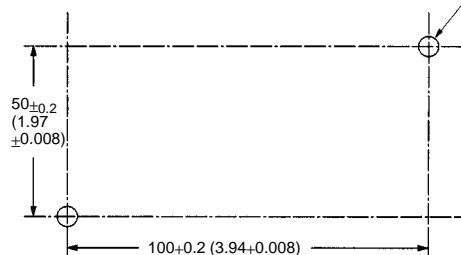

GENERAL-PURPOSE CONNECTING CABLES

Unit: mm (inch)

G79-Y□C Cable with Crimp Terminals

Convenient for connecting screw terminals to Output Blocks

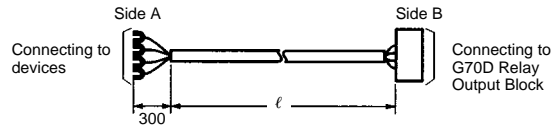
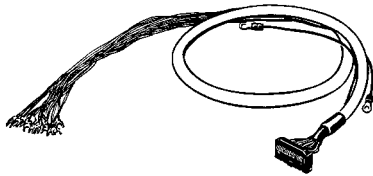

G79-A□C Cable with Loose Wires

Device connection end provides loose wires.

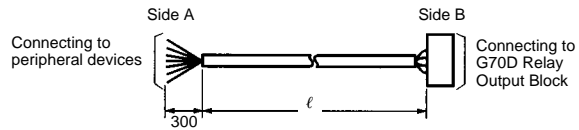
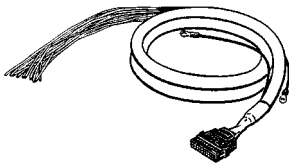

With loose wires and crimp terminals		With loose wires	
Length (ℓ)	Part number	Length (ℓ)	Part number
1,000 mm (3.28 ft)	G79-Y100C	2,000 mm (6.56 ft)	G79-A200C
1,500 mm (4.92 ft)	G79-Y150C	5,000 mm (16.40 ft)	G79-A500C
2,000 mm (6.56 ft)	G79-Y200C		
3,000 mm (9.84 ft)	G79-Y300C		
5,000 mm (16.40 ft)	G79-Y500C		

DEDICATED CONNECTING CABLES FOR OMRON PLC MODULES

Guidelines

The number of I/O points used must correspond to the number of Output Blocks.
 The number of I/O connectors used must correspond to the number of cables.

G79-□C Cable with Connector (1:1)

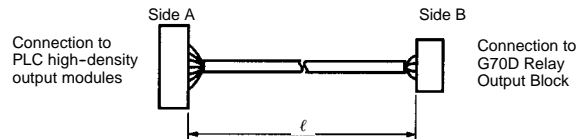
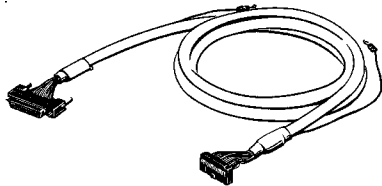

Applicable Omron PLC High-density I/O Modules		Connector Cable for Output Blocks	
Part number	No. of output points	Length (ℓ)	Part number
C200H-OD215	32 output points (2 cables)	1,000 mm	G79-100C
C200H-MD215	16 inputs/16 outputs (1 cable)	1,500 mm	G79-150C
C500-OD415CN	32 output points (2 cables)	2,000 mm	G79-200C
C500-MD211CN	16 inputs/16 outputs (1 cable)	3,000 mm	G79-300C
		5,000 mm	G79-500C

G79-O□C-□ Cable with Connector (1:2)

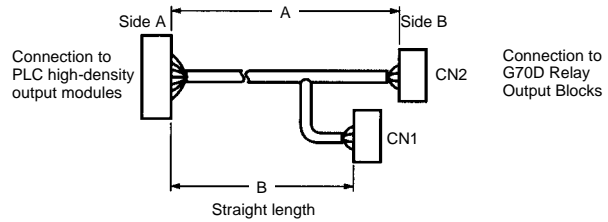
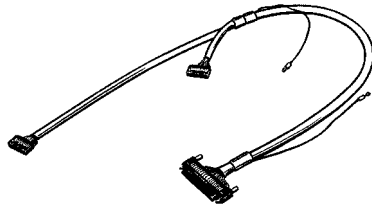

Applicable Omron PLC High-density I/O Modules		Connector Cable for Output Blocks		
Part number	No. of output points	Length (ℓ)		Part number
		A	B	
C200H-OD218	32 points (1 cable)	1,000 mm (3.28 ft)	750 mm (2.46 ft)	G79-O100C-75
C200H-OD219	64 points (2 cables)	1,500 mm (4.92 ft)	1,250 mm (4.10 ft)	G79-O150C-125
C500-OD213	64 points (2 cables)	2,000 mm (6.56 ft)	1,750 mm (5.74 ft)	G79-O200C-175
CQM1-OD213	32 points (1 cable)	3,000 mm (9.84 ft)	2,750 mm (9.02 ft)	G79-O300C-275
		5,000 mm (16.40 ft)	4,750 mm (15.58 ft)	G79-O500C-475

G79-□C-□-□ Cable with Connector (1:3)

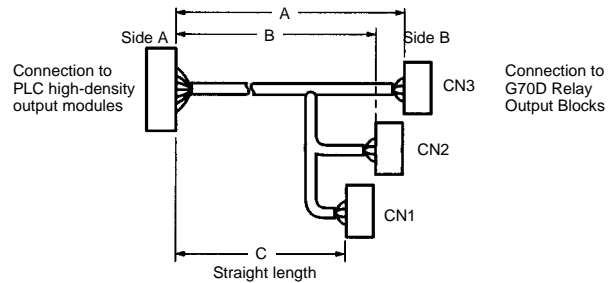
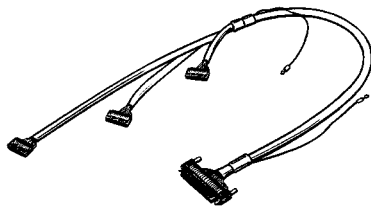

Applicable Omron PLC High-density I/O Modules		Connector Cable for Output Blocks			Part number
Part number	No. of output points	Length (ℓ)			
		A	B	C	
CS1W-OD29□	96 points (2 cables)	1,500 mm (4.92 ft)	1,250 mm (4.10 ft)	1,000 mm (3.28 ft)	G79-150C-125-100
CS1W-MD29□	48 inputs/48 outputs (1 cable)	2,000 mm (6.56 ft)	1,750 mm (5.74 ft)	1,500 mm (4.92 ft)	G79-200C-175-150
		3,000 mm (9.84 ft)	2,750 mm (9.02 ft)	2,500 mm (8.20 ft)	G79-300C-275-250

■ ACCESSORIES

Unit: mm (inch)

These accessories are for G70D-VSOC16 and G70D-VFOM16 Terminal Blocks.

G70D-ET Expansion Terminal Block

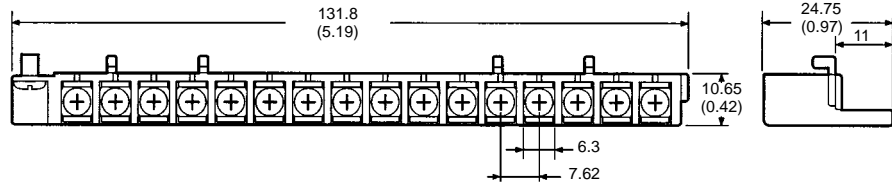
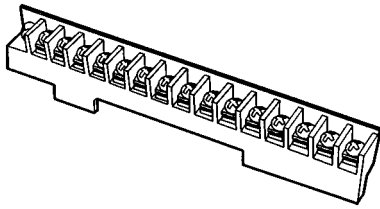

G6D-4-SB Short Bar

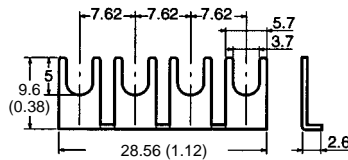
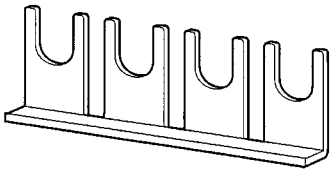

Precautions

■ GENERAL PRECAUTIONS

The G70D is used only for outputs.

Electric Shock

It is extremely dangerous to connect or disconnect relays with the power turned on. Always turn off the power before wiring the Output Block or replacing the relays.

Do not connect or disconnect connectors with the power turned on; faulty operation may occur.

Wiring

Be sure to turn OFF the power when wiring the Output Block and do not touch the charged terminals of the Output Block, or an electric shock may result. Turn ON the power after the Output Block is wired and the relay block is mounted.

Apply specified voltages to the input terminals. Otherwise, the Output Block may malfunction, be damaged, or burn.

Relay Models

Do not connect the Output Block to any load exceeding the rated switching voltage or current of the Output Block. Otherwise, faulty insulation, contact weld, or faulty contact of the Relays, damage to the Relays may result or the Relays may malfunction or burn.

The life of a Relay varies with the switching condition. Test the Relays under the actual operating conditions before using the Relays within the permissible switching frequency. The use of deteriorated Relays may result in the faulty insulation of the Relays or cause the Relays to burn.

Do not use the Output Block in places with flammable gas. A fire or explosion may result from the heat of the Relays or a spark from the Relays when they are switched.

Power MOSFET Models

Do not connect the Output Block to loads consuming a total current exceeding the rated output current of the Output Block. You may damage the output element and a short or open-circuit malfunction may result.

If the Output Block is connected to a DC inductive load, connect a diode to the Output Block to protect against counter-electromotive voltage. This may result in damage to the output element and a short or open-circuit malfunction.

■ CORRECT USE

Replacing Relays

The G70D-SOC16(-1) and G70D-VSOC16 are equipped with G6D-1A, 24 VDC relays. The G70D-FOM16(-1) and G70D-VFOM16 are equipped with G3DZ-2R6PL, 24 VDC power MOSFET solid state relays.

Turn OFF the Output Block to replace Relays. Otherwise, an electric shock may result or the Output Block may malfunction.

Mount the Relay by pressing the upper part straight down until the Relay is locked with the hooks. Make sure none of the Relay terminals are bent or the Output Block may malfunction or radiate heat.

Wiring

Make sure that the polarity of each terminal is correct, the power lines are wired properly, and the terminal voltage is appropriate.

Do not disconnect or connect the connector while the Output Block is turned ON. Otherwise, the Output Block may malfunction.

Cable Connector Locks

Before the Output Block is turned ON, make sure that the connectors of all the cables connected to the Output Block are locked.

Installation Environment

Do not install the Output Block in the following locations or damage or malfunction may result.

- Locations with direct sunlight.
- Locations with ambient temperature ranges not within -25°C to 55°C (-13°F to 131°F).
- Locations with rapid temperature changes resulting in condensation or relative humidity exceeding 45% to 85%.
- Locations with corrosive or inflammable gas.
- Locations with excessive dust, salinity, or metal powder.
- Locations with vibration or shock affecting the Output Block.
- Locations with water, oil, or chemical sprayed on the Output Block.

Screw Tightening Torque

Tighten all screws of the Output Block properly, or the Output Block may malfunction.

- Terminal screws: Tighten each terminal screw to a torque of 0.78 to 1.18 N • m.
- Mounting screws: Tighten each mounting screw to a torque of 0.59 to 0.98 N • m
- Relay block mounting screws: Tighten each mounting screw to a torque of 0.59 to 0.98 N • m.

Cleaning

Do not use paint thinner to clean the surface because damage or discoloration may result.

Handling

Do not drop the Output Block or shock or vibrate the Output Block excessively. This may damage the Output Block and result in malfunction.

Disassembling, Repairing, and Modifying

Do not disassemble, repair, or modify the Output Block. An electric shock may result or the Output Block may malfunction.

Output Block Configuration

G70D-SOC/G70D-FOM

To open the protective cover, lift cover at both points marked "A" in the following illustration.

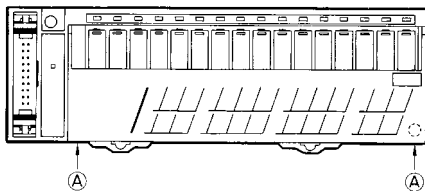

Use the Relay Removal Tool provided to the left of the screw terminals when replacing relays.

G70D-VSOC/G70D-VFOM

For ease-of-use and space-saving, the G70D-VSOC16 incorporates a terminal block and relay block that can be separated from the Output Block. The relay block has operation indicators and replaceable Relays along with electrical check terminals for monitoring the operation of the Output Block.

The Expansion Terminal Block can be mounted to the Output Block for power line connections.

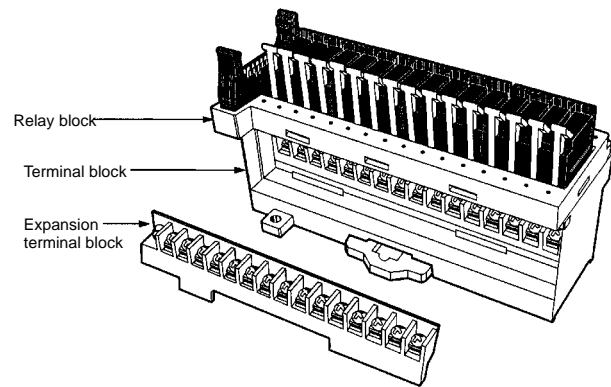

Removing and Mounting the Terminal Block and Relay Block

Refer to the diagram below.

1. Removing

Check that the load and the Output Block are both turned OFF.

Turn the mounting screws of the relay block counterclockwise alternately and equally until the relay block is slightly raised.

When the relay block is slightly raised, disconnect the protruding part A of the relay block from the interior wall of the Output Block.

Further turn the mounting screws counterclockwise and remove the mounting screws. Then remove the relay block.

2. Mounting

Check that the load and the Output Block are both turned OFF.

Check that the part B of the terminal block is free of metal dust or other foreign materials.

Mount the relay block straight along the groove of the terminal block.

Press the both ends of the relay block and place the protruding part A onto the interior wall of the Output Block.

Tighten the mounting screws of the relay block clockwise alternately and equally to secure the relay block

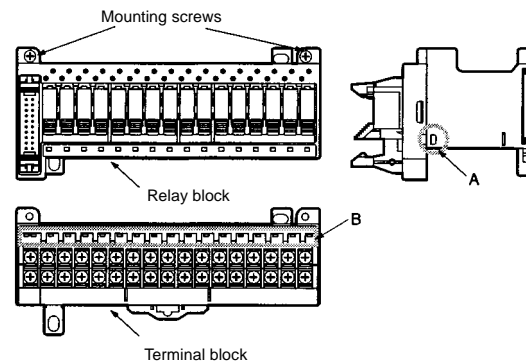

Nameplate of Terminal Block

As shown in Figure 1, the nameplate of the terminal block is located on the bottom surface of the relay block.

To fill in the nameplate, remove the nameplate from the relay block. Then return it to the original location when finished.

To read the nameplate after the Output Block is mounted to a panel, for example, pull out the nameplate from the bottom surface of the relay block as shown in Figure 2.

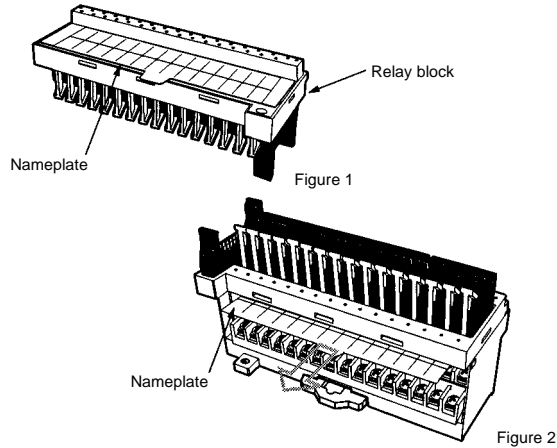

Electrical Check Terminals

The terminal block of the G70D-VS0C16 in operation is located under the relay block. Therefore, unlike the terminal blocks of other models, electrical checks on the terminals are not possible with multimeter probes. The relay block of the G70D-VS0C16, however, incorporates electrical check terminals, each of which is connected to the corresponding terminal of the terminal block. All the pairs of these terminals share single terminal numbers respectively.

To check these terminals, apply multimeter probes to these terminals.

Do not touch these energized terminals with a thin metal object or similar objects. Doing so may result in an electric shock.

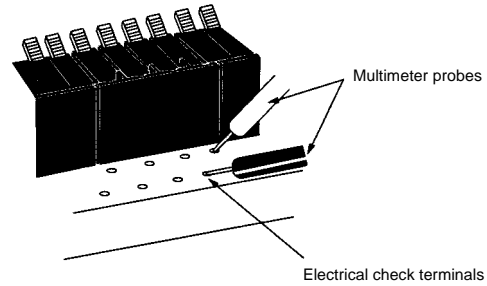

Mounting the Expansion Terminal Block

Insert the hooks of the Expansion Terminal Block into the mounting holes on the terminal block and slide the Expansion Terminal Block so that it will not separate from the terminal block.

Tighten the mounting screw of the Expansion Terminal Block securely.

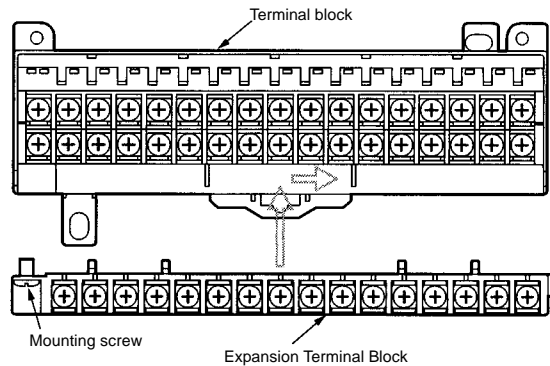

NOTE: DIMENSIONS SHOWN ARE IN MILLIMETERS. To convert millimeters to inches divide by 25.4.

OMRON®

OMRON ELECTRONICS, INC.

One East Commerce Drive
Schaumburg, IL 60173

1-800-55-OMRON

OMRON CANADA, INC.

885 Milner Avenue
Scarborough, Ontario M1B 5V

416-286-6465