

## HIGH EFFICIENCY ULTRAFAST DIODE

### MAIN PRODUCT CHARACTERISTICS

<b>I<sub>F(AV)</sub></b>	<b>3A</b>
<b>V<sub>RRM</sub></b>	<b>200 V</b>
<b>T<sub>j</sub> (max)</b>	<b>175 °C</b>
<b>V<sub>F</sub> (max)</b>	<b>0.75 V</b>
<b>trr (max)</b>	<b>35 ns</b>

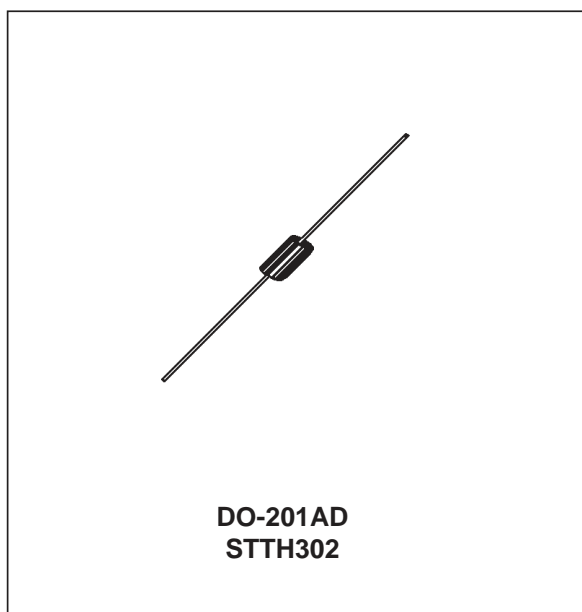
### FEATURES AND BENEFITS

- Very low conduction losses
- Negligible switching losses
- Low forward and reverse recovery times
- High junction temperature

### DESCRIPTION

The STTH302 which is using ST's new 200V planar technology, is specially suited for switching mode base drive & transistor circuits.

The device is also intended for use as a free wheeling diode in power supplies and other power switching applications.



### ABSOLUTE RATINGS (limiting values)

Symbol	Parameter		Value	Unit
V <sub>RRM</sub>	Repetitive peak reverse voltage		200	V
I <sub>F(AV)</sub>	Average forward current	T <sub>I</sub> = 107°C    δ = 0.5	3	A
I <sub>FSM</sub>	Surge non repetitive forward current	t <sub>p</sub> = 10ms    Sinusoidal	130	A
T <sub>stg</sub>	Storage temperature range		- 65 to + 175	°C
T <sub>j</sub>	Maximum operating junction temperature		175	°C

### THERMAL PARAMETERS

Symbol	Parameter	Value	Unit
R <sub>th(j-a)</sub>	Junction-ambient*	25	°C/W

\* On infinite heatsink with 10mm lead length.

## STATIC ELECTRICAL CHARACTERISTICS

Symbol	Parameter	Test Conditions		Min.	Typ.	Max.	Unit
$I_R^*$	Reverse leakage current	$T_j = 25^\circ\text{C}$	$V_R = V_{RRM}$			3	$\mu\text{A}$
		$T_j = 125^\circ\text{C}$			4	75	
$V_F^{**}$	Forward voltage drop	$T_j = 25^\circ\text{C}$	$I_F = 3\text{A}$			0.95	V
		$T_j = 125^\circ\text{C}$			0.66	0.75	

Pulse test : \*  $t_p = 5\text{ ms}$ ,  $\delta < 2\%$

\*\*  $t_p = 380\ \mu\text{s}$ ,  $\delta < 2\%$

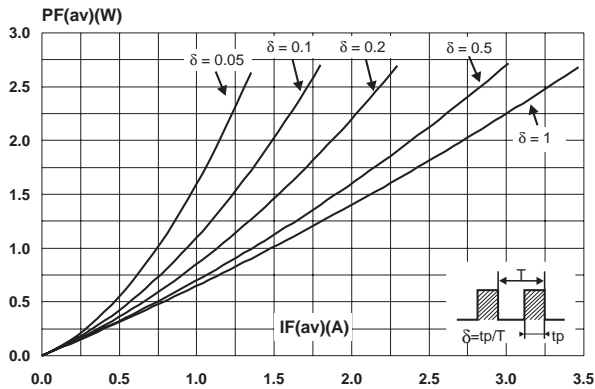
To evaluate the maximum conduction losses use the following equations:

$$P = 0.60 \times I_{F(AV)} + 0.05 I_{F(RMS)}^2$$

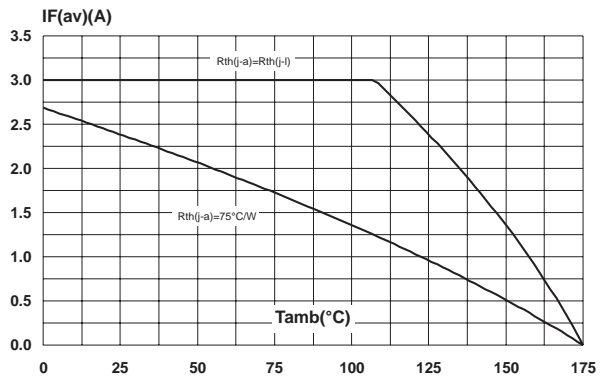
## DYNAMIC ELECTRICAL CHARACTERISTICS

Symbol	Parameter	Test conditions		Min.	Typ.	Max.	Unit
$t_{rr}$	Reverse recovery time	$I_F = 1\text{A}$ $dI_F/dt = -50\text{A}/\mu\text{s}$ $V_R = 30\text{V}$	$T_j = 25^\circ\text{C}$			35	ns
$t_{fr}$	Forward recovery time	$I_F = 3\text{A}$ $dI_F/dt = 50\text{A}/\mu\text{s}$ $V_{FR} = 1.1 \times V_F \text{ max}$	$T_j = 25^\circ\text{C}$		70		ns
$V_{FP}$	Forward recovery voltage		$T_j = 25^\circ\text{C}$		1.6		V

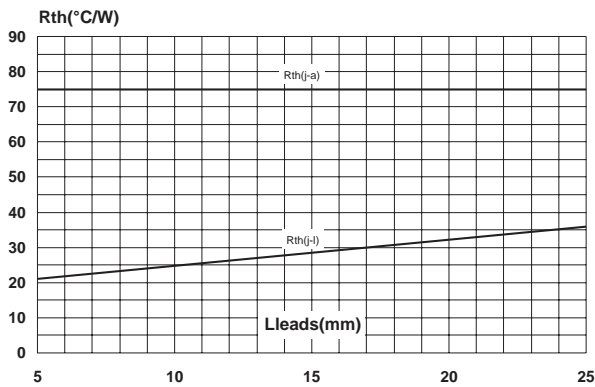
**Fig. 1:** Average forward power dissipation versus average forward current.



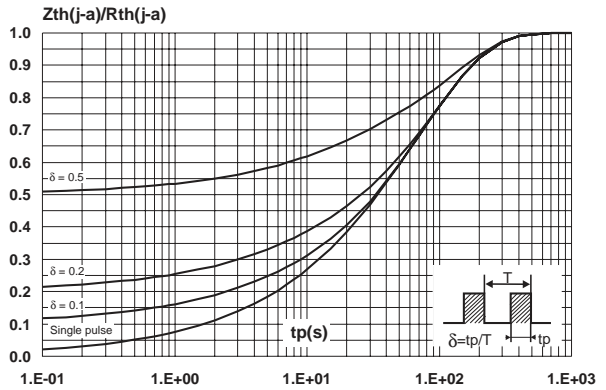
**Fig. 2:** Average forward current versus ambient temperature ( $\delta=0.5$ ).



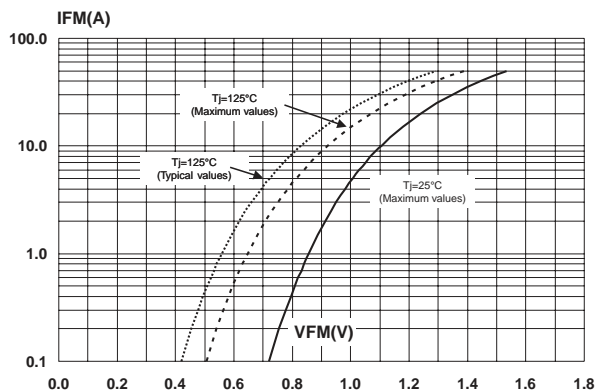
**Fig. 3:** Thermal resistance versus lead length.



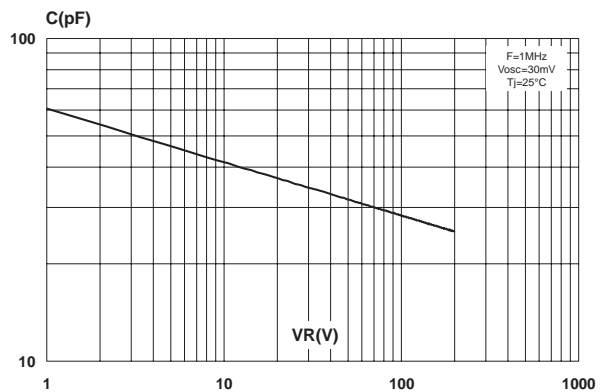
**Fig. 4:** Relative variation of thermal impedance junction ambient versus pulse duration (printed circuit board epoxy FR4, Leads = 10mm).



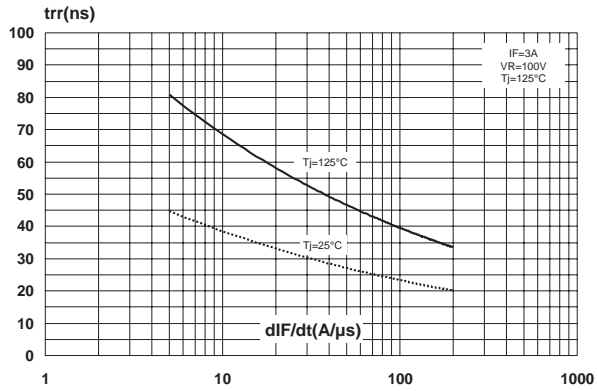
**Fig. 5:** Forward voltage drop versus forward current.



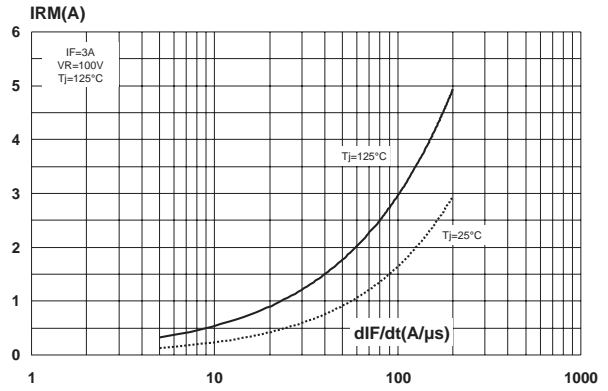
**Fig. 6:** Junction capacitance versus reverse voltage applied (typical values).



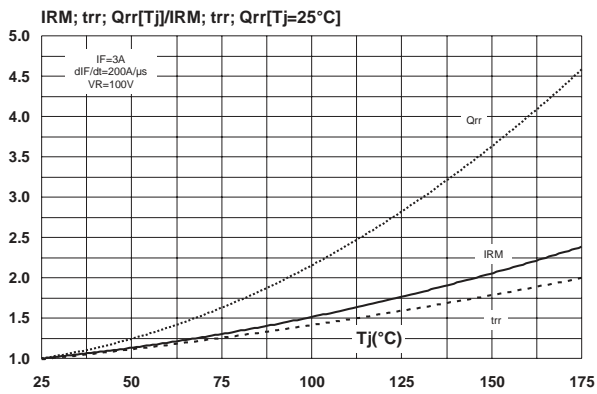
**Fig. 7:** Reverse recovery time versus  $di_F/dt$  (90% confidence).



**Fig. 8:** Peak reverse recovery current versus  $di_F/dt$  (90% confidence).

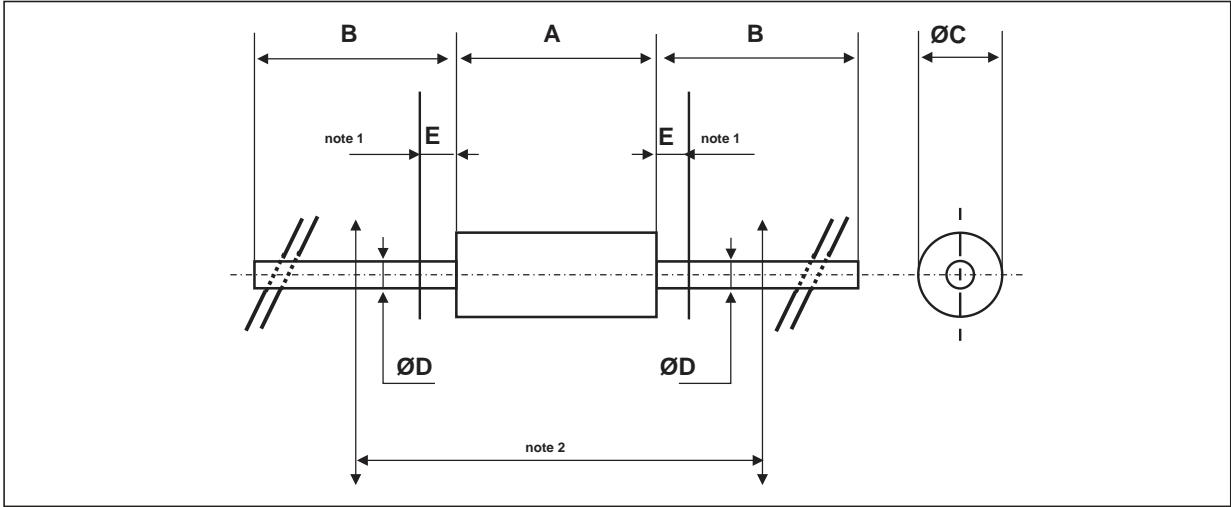


**Fig. 9:** Relative variations of dynamic parameters versus junction temperature.



**PACKAGE MECHANICAL DATA**

DO-201AD



REF.	DIMENSIONS				NOTES
	Millimeters		Inches		
	Min.	Max.	Min.	Max.	
A		9.50		0.374	1 - The lead diameter $\varnothing D$ is not controlled over zone E  2 - The minimum axial length within which the device may be placed with its leads bent at right angles is 0.59" (15 mm)
B	25.40		1.000		
$\varnothing C$		5.30		0.209	
$\varnothing D$		1.30		0.051	
E		1.25		0.049	

Ordering code	Marking	Package	Weight	Base qty	Delivery mode
STTH302	STTH302	DO-201AD	1.16 g	600	Ammopack
STTH302RL	STTH302	DO-201AD	1.16 g	1900	Tape and reel

- White band indicates cathode
- Epoxy meets UL94,V0

Information furnished is believed to be accurate and reliable. However, STMicroelectronics assumes no responsibility for the consequences of use of such information nor for any infringement of patents or other rights of third parties which may result from its use. No license is granted by implication or otherwise under any patent or patent rights of STMicroelectronics. Specifications mentioned in this publication are subject to change without notice. This publication supersedes and replaces all information previously supplied. STMicroelectronics products are not authorized for use as critical components in life support devices or systems without express written approval of STMicroelectronics.

The ST logo is a registered trademark of STMicroelectronics  
 © 2001 STMicroelectronics - Printed in Italy - All rights reserved.  
 STMicroelectronics GROUP OF COMPANIES  
 Australia - Brazil - Canada - China - Finland - France - Germany  
 Hong Kong - India - Israel - Italy - Japan - Malaysia - Malta - Morocco - Singapore  
 Spain - Sweden - Switzerland - United Kingdom - United States.  
<http://www.st.com>

