

Type 0ADGX

High In-Rush Fuse Series

 0ADGX Series, 6x32mm Ceramic Tube High In-Rush Fuse

RoHS Compliant

Description

500VAC/DC rated ceramic tube cartridge fuse in a compact 6 x 32mm package.

Features

- High I²T withstand High In-Rush Current
- High breaking capacity for high energy application
- Full compliance with EU Directive 2011/65/EU and amending directive 2015/863
- Lead Free

Applications



- Industrial Power Supplies
- Charging Module for EV/HEV

LEAD FREE = 



UK CA c  CE

Physical Specifications

Materials	Body : Ceramic
	Cap: Silver Plated Caps
	Pigtail Leads : Tin Plated Copper
Marking	On Fuse :
	"bel"
	"0ADGX", "Current Rating", "Voltage Rating", "Appropriate Safety Logos"
	On Label :
	"bel", "0ADGX", "Current Rating", "Voltage Rating", "Interrupting Rating", "Appropriate Safety Logos" and "  ", "  "(China RoHS compliant).

Electrical Characteristics

Testing Current	Opening Time
100%	4 hours, Minimum
250%	60 seconds, Maximum

Safety Agency Approvals

Safety Agency	Safety Agency Certificate	Ampere Rating / Voltage Rating	Ampere Range / Volt @ I.R. ability*
	E20624	8A-30A/500V AC/DC	8A-30A/500V@1kA AC/DC
*I.R.= Interrupting Rating = Short Circuit Rating(Amps)			

Environmental Specifications

Operating Temperature	-50°C to 125°C
Terminal Strength	MIL-STD-202, Method 211, Test Condition A
Lead Solderability	MIL-STD-202, Method 208
Mechanical Vibration	MIL-STD-202, Method 201
Thermal Shock	MIL-STD-202, Method 107, Test Condition B (5 cycles -65°C to 125°C)
Humidity	MIL-STD-202, Method 103, Test Condition A: 95%RH and 40°C for 240 hours

Electrical Specifications

Part Number	Ampere Rating	Typical Cold Resistance (mOhms)	Voltage and Interrupting Ratings	Typical Pre-Arcing I ² t (A ² Sec)
0ADGX8000-XX	8A	15	See Table of Ratings on Page 1 for Voltage and associated Interrupting Ratings	165
0ADGX9100-XX	10A	11.5		260
0ADGX9160-XX	16A	5.3		410
0ADGX9200-XX	20A	4.0		680
0ADGX9250-XX	25A	3.0		1500
0ADGX9300-XX	30A	2.5		2350

Consult manufacturer for other ratings

* DC Cold Resistance are measured at <10% of rated current in ambient temperature of 25°C

* Typical Pre-arcing I²t are measured at 10In Current

Temperature Re-Rating Curve

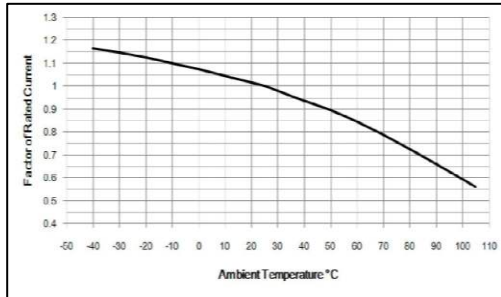

Average Time Current Curve

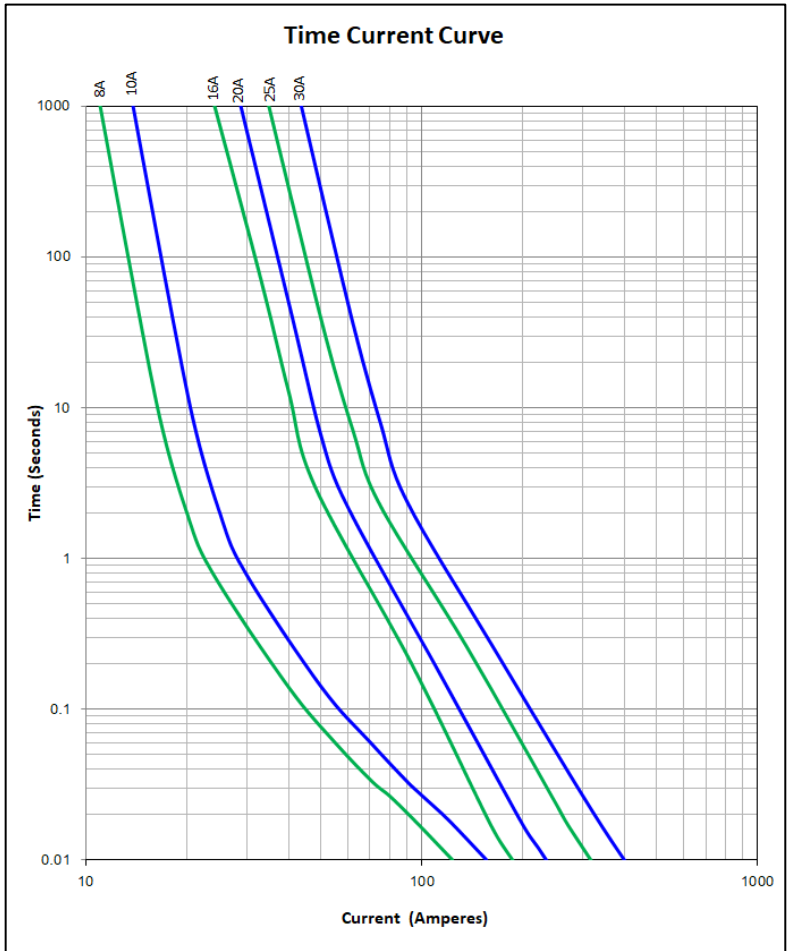

Soldering parameters

Wave Soldering:

Solder Pot Temperature: 260°C Max.

Solder Dwell Time: 10s Max.

Hand-Solder:

Solder Iron Temperature: 350°C +/- 5°C

Heating Time: 5s Max.



Specifications subject to change without notice

Bel Fuse Inc.
206 Van Vorst Street
Jersey City, NJ 07302 USA

+1 201.432.0463
Bel.US.CS@belf.com
belfuse.com/circuit-protection

© 2023 Bel Fuse, Inc.

Rev. :0ADGX Apr2023

Fuse FGNO Explanation

0ADG X [XXXX] -XX

0ADGC/P/W=0ADGC/P/W; [XXXX]=Ampere Rating; XX=See Ordering Information as below

Amps	Bel FGNO[XXXX]
10	9100
16	9160
20	9200
25	9250
30	9300

Mechanical Dimensions

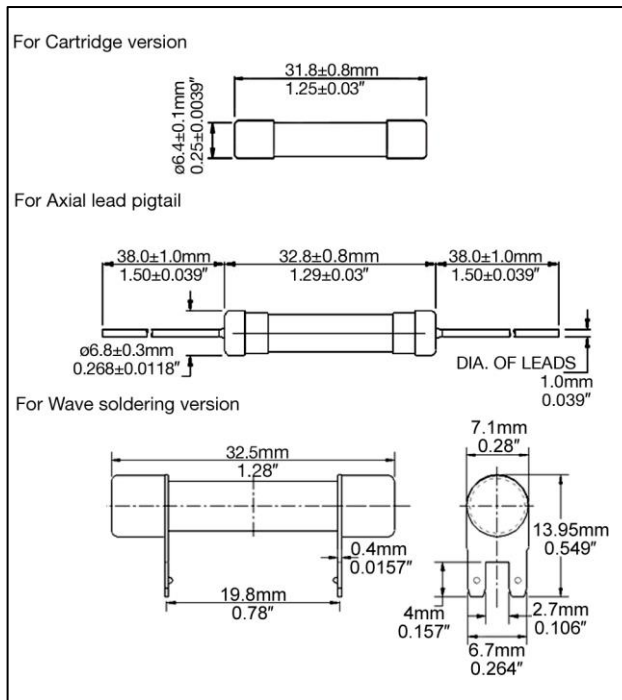

Ordering Information

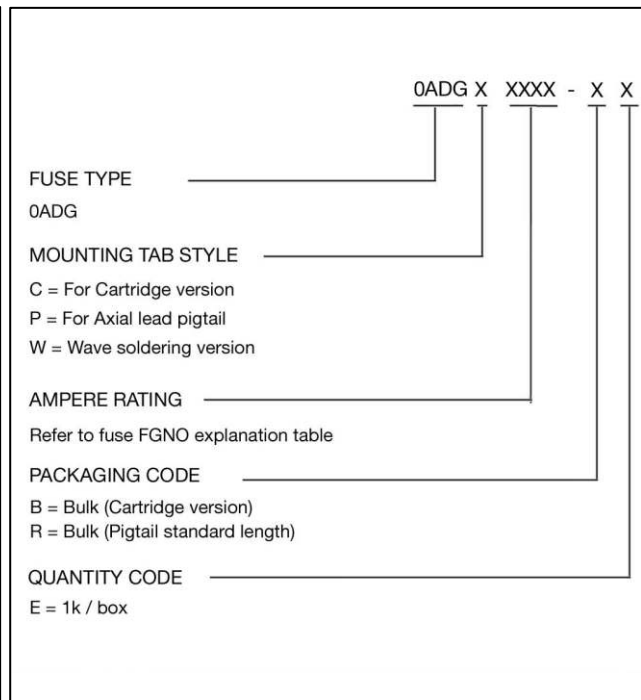

Packaging

Packaging Option	Quantity	Packaging Code
Bulk	1000	BE
Bulk (Pigtail standard length)	1000	RE