

## AN-1691 LM20143 Evaluation Board

### 1 Introduction

The LM20143 is a full featured buck switching regulator capable of driving up to 3A of load current. The switching frequency of the LM20143 can be varied from 500kHz to 1.5MHz with an external resistor allowing the size of the power stage components to be reduced while still providing efficient operation. The LM20143 is capable of converting an input voltage between 2.95 V and 5.5 V down to an output voltage as low as 0.8 V. Fault protection features include cycle-by-cycle current limit, output power good, and output over-voltage protection. The dual function soft-start/tracking pin can be used to control the startup response of the LM20143, and the precision enable pin can be used to easily sequence the LM20143 in applications with sequencing requirements. The LM20143 is available in a 16-pin HTSSOP package with an exposed pad for enhanced thermal performance.

The LM20143 evaluation board has been designed to balance overall solution size with the efficiency of the regulator. The evaluation board measures just under 1.3" x 1.1" on a two layer PCB, with all components placed on the top layer. The power stage and compensation components of the LM20143 evaluation board have been optimized for an input voltage of 5 V and a switching frequency of 1.5 MHz, but for testing purposes, the input can be varied across the entire operating range. The output voltage of the evaluation board is nominally 1.2 V, but this voltage can be easily changed by replacing one of the feedback resistors ( $R_{FB1}$  or  $R_{FB2}$ ). The control loop compensation of the LM20143 evaluation board has been designed to provide a stable solution over the entire input and output voltage range with a reasonable transient response. The EN pin must be above 1.18 V (typ) on the board to initiate switching. If the EN function is not necessary, the EN pin should be externally tied to  $V_{IN}$ .

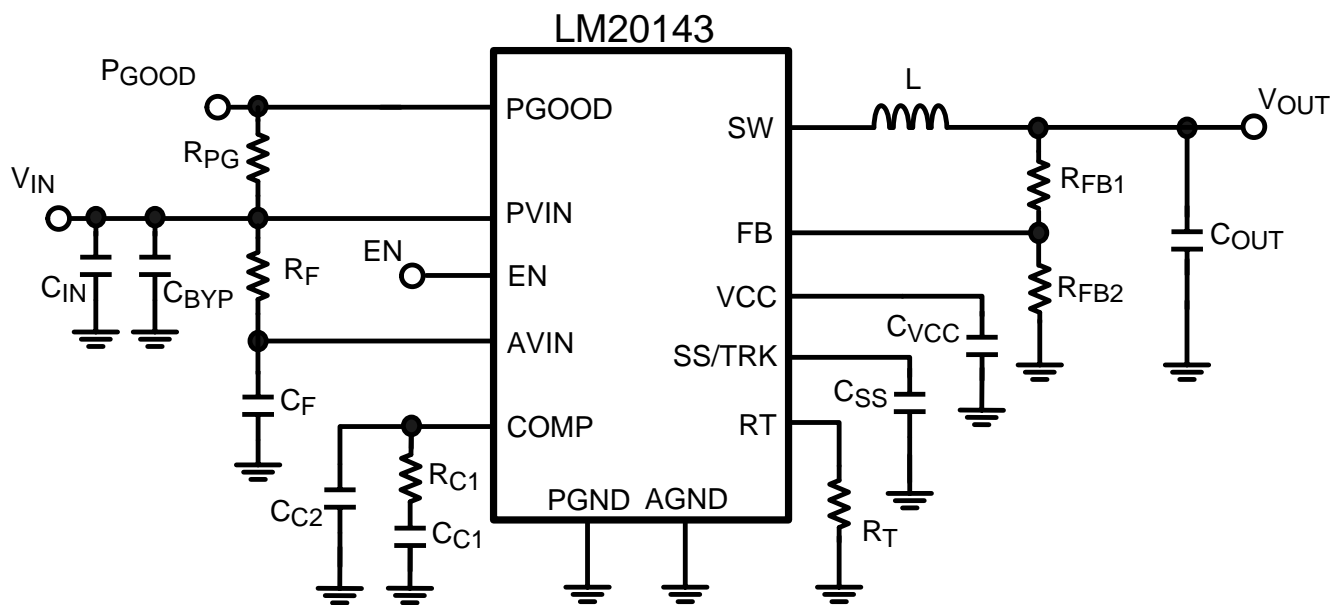

**Figure 1. Evaluation Board Schematic**

## 2 Bill of Materials (BOM)

Designator	Description	Part Number	Qty	Manufacturer
U1	Synchronous Buck Regulator	LM20143	1	Texas Instruments
C <sub>IN</sub>	47 $\mu$ F, 1210, X5R, 6.3 V	GRM32ER60J476ME20	1	Murata
C <sub>BYP</sub>	1 $\mu$ F, 0603, X5R, 6.3 V	GRM188R60J105KA01	1	Murata
C <sub>OUT</sub>	47 $\mu$ F, 1210, X5R, 6.3 V	GRM32ER60J476ME20	1	Murata
L	1.2 $\mu$ H, 17 m $\Omega$	DO1813H-122ML	1	Coilcraft
R <sub>F</sub>	1 $\Omega$ , 0603	CRCW06031R0J-e3	1	Vishay-Dale
C <sub>F</sub>	100 nF, 0603, X7R, 16 V	GRM188R71C104KA01	1	Murata
CV <sub>CC</sub>	1 $\mu$ F, 0603, X5R, 6.3 V	GRM188R60J105KA01	1	Murata
R <sub>PG</sub>	10 k $\Omega$ , 0603	CRCW06031002F-e3	1	Vishay-Dale
R <sub>C1</sub>	1 k $\Omega$ , 0603	CRCW06031001F-e3	1	Vishay-Dale
C <sub>C1</sub>	4.7 nF, 0603, X7R, 25 V	VJ0603Y472KXXA	1	Vishay-Vitramon
C <sub>C2</sub>	OPEN	OPEN	0	N/A
C <sub>SS</sub>	33 nF, 0603, X7R, 25 V	VJ0603Y333KXXA	1	Vishay-Vitramon
R <sub>FB1</sub>	4.99 k $\Omega$ , 0603	CRCW06034991F-e3	1	Vishay-Dale
R <sub>FB2</sub>	10 k $\Omega$ , 0603	CRCW06031002F-e3	1	Vishay-Dale
R <sub>T</sub>	49.9 k $\Omega$ , 0603	CRCW06034992F-e3	1	Vishay-Dale
Test Points	Test Points	160-1026-02-01-00	7	Cambion

## 3 Connection Descriptions

Terminal Silkscreen	Description
V <sub>IN</sub>	This terminal is the input voltage to the device. The device will operation over the input voltage range of 2.95 V to 5.5 V. The absolute maximum voltage rating for this pin is 6 V.
GND	This terminal is the ground connection to the device. There are two different GND connections on the PCB. One should be used for the input supply and the other for the load.
V <sub>OUT</sub>	This terminal connects to the output voltage of the power supply and should be connected to the load.
EN	This terminal connects to the enable pin of the device. This terminal should be connected to V <sub>IN</sub> or driven externally. If driven externally, a voltage typically greater than 1.18 V will enable the device. The operating voltage for this pin should not exceed 5.5 V. The absolute maximum voltage rating on this pin is 6 V.
SS/TRACK	This terminal provides access to the SS/TRK pin of the device. Connections to this terminal are not needed for most applications. The feedback pin of the device will track the voltage on the SS/TRK pin if it is driven with an external voltage source that is below the 0.8 V reference. The voltage on this pin should not exceed 5.5 V during normal operation. The absolute maximum voltage rating on this pin is 6 V.
PGOOD	This terminal connects to the power good output of the device. There is a 10 k $\Omega$ pull-up resistor from this pin to the input voltage. The voltage on this pin should not exceed 5.5 V during normal operation and has an absolute maximum voltage rating of 6 V.

## 4 Performance Characteristics

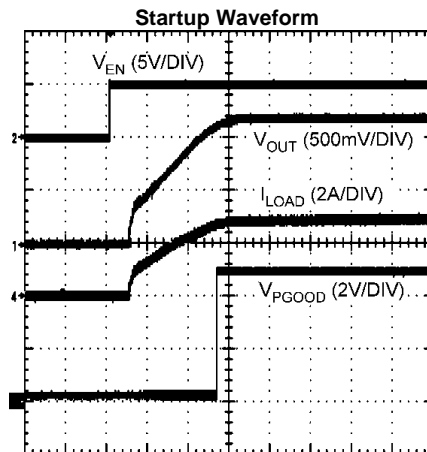
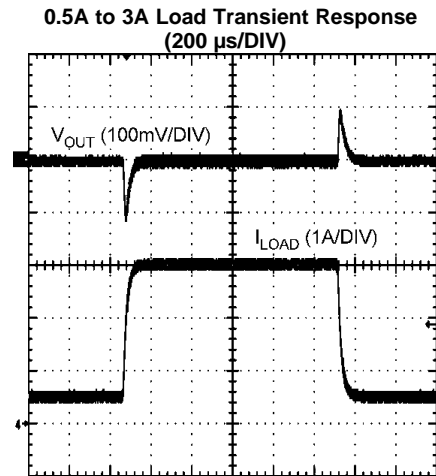
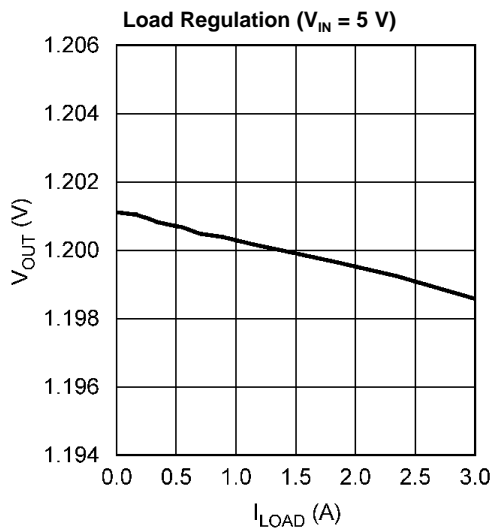
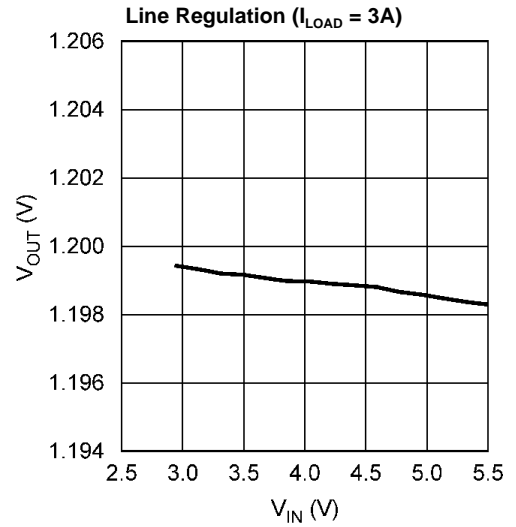
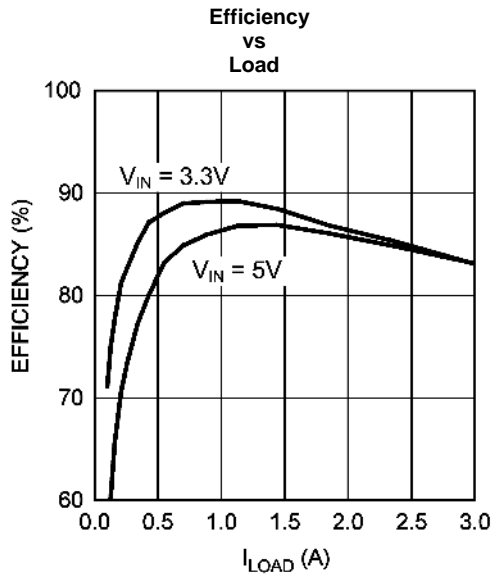

## 5 Component Selection

This section provides a walk-through of the design process of the LM20143 evaluation board. Unless otherwise indicated, all equations assume units of Amps (A) for current, Farads (F) for capacitance, Henries (H) for inductance, and Volts (V) for voltages.

### 5.1 Input Capacitor

The required RMS current rating of the input capacitor for a buck regulator can be estimated by [Equation 1](#):

$$I_{CIN(RMS)} = I_{OUT} \sqrt{D(1-D)} \quad (1)$$

The variable D refers to the duty cycle, and can be approximated by:

$$D = \frac{V_{OUT}}{V_{IN}} \quad (2)$$

From [Equation 3](#), it follows that the maximum  $I_{CIN(RMS)}$  requirement will occur at a full 3A load current with the system operating at 50% duty cycle. Under this condition, the maximum  $I_{CIN(RMS)}$  is given by:

$$I_{CIN(RMS)} = 3A \sqrt{0.5 \times 0.5} = 1.5A \quad (3)$$

Ceramic capacitors feature a very large  $I_{RMS}$  rating in a small footprint, making a ceramic capacitor ideal for this application. A 47  $\mu$ F X5R ceramic capacitor from Murata provides the necessary input capacitance for the evaluation board. For improved bypassing, a small 1  $\mu$ F high frequency capacitor is placed in parallel with the 47  $\mu$ F bulk capacitor to filter high frequency noise pulses on the supply.

### 5.2 AVIN Filter

An RC filter should be added to prevent any switching noise on PVIN from interfering with the internal analog circuitry connected to AVIN. These can be seen on the schematic as components  $R_F$  and  $C_F$ . There is a practical limit to the size of the resistor  $R_F$  as the AVIN pin will draw a short 60mA burst of current during startup, and if  $R_F$  is too large the resulting voltage drop can trigger the UVLO comparator. For the demo board a 1  $\Omega$  resistor is used for  $R_F$  ensuring that UVLO will not be triggered after the part is enabled. A recommended 1  $\mu$ F  $C_F$  capacitor coupled with the 1  $\Omega$  resistor provides greater than 16dB of attenuation at the set 1.5 MHz switching frequency.

### 5.3 Inductor

As per the datasheet recommendations, the inductor value should initially be chosen to give a peak-to-peak ripple current equal to roughly 30% of the maximum output current. The peak-to-peak inductor ripple current can be calculated by [Equation 4](#):

$$\Delta I_{P-P} = \frac{(V_{IN} - V_{OUT}) \times D}{L \times f_{SW}} \quad (4)$$

Rearranging this equation and solving for the inductance reveals that for this application ( $V_{IN} = 5$  V,  $V_{OUT} = 1.2$  V,  $f_{SW} = 1.5$  MHz, and  $I_{OUT} = 3$  A) the nominal inductance value is roughly 0.68  $\mu$ H. However, a final inductance of 1.2  $\mu$ H was selected to accommodate the full output voltage range of the device. This results in a peak-to-peak ripple current of 507 mA and 623 mA when the converter is operating from 5 V and 3.3 V, respectively. Once an inductance value is calculated, an actual inductor needs to be selected based on a trade-off between physical size, efficiency, and current carrying capability. For the LM20143 evaluation board, a Coilcraft DO1813H-122ML inductor offers a good balance between efficiency (17 m $\Omega$  DCR), size, and saturation current rating (5.3A  $I_{SAT}$  rating).

### 5.4 Output Capacitor

The value of the output capacitor in a buck regulator influences the voltage ripple that will be present on the output voltage, as well as the large signal output voltage response to a load transient. Given the peak-to-peak inductor current ripple ( $\Delta I_{P-P}$ ) the output voltage ripple can be approximated by [Equation 5](#):

$$\Delta V_{OUT} = \Delta I_{P-P} \times \left[ R_{ESR} + \frac{1}{8 \times f_{SW} \times C_{OUT}} \right] \quad (5)$$

The variable  $R_{ESR}$  above refers to the ESR of the output capacitor. As can be seen in [Equation 5](#), the ripple voltage on the output can be divided into two parts, one of which is attributed to the AC ripple current flowing through the ESR of the output capacitor and another due to the AC ripple current actually charging and discharging the output capacitor. The output capacitor also has an effect on the amount of droop that is seen on the output voltage in response to a load transient event.

For the evaluation board, a Murata 47  $\mu\text{F}$  ceramic capacitor is selected for the output capacitor to provide good transient and DC performance in a relatively small package. From the technical specifications of this capacitor, the ESR is roughly 3  $\text{m}\Omega$ , and the effective in-circuit capacitance is approximately 32  $\mu\text{F}$  (reduced from 47  $\mu\text{F}$  due to the 1.2 V DC bias). With these values, the peak-to-peak voltage ripple on the output when operating from a 5 V input can be calculated to be 3 mV.

## 5.5 $C_{SS}$

A soft-start capacitor can be used to control the startup time of the LM20143 voltage regulator. The startup time of the regulator when using a soft-start capacitor can be estimated by [Equation 6](#):

$$t_{SS} = \frac{0.8V \times C_{SS}}{I_{SS}} \quad (6)$$

For the LM20143,  $I_{SS}$  is nominally 5  $\mu\text{A}$ . For the evaluation board, the soft-start time has been designed to be roughly 5 ms, resulting in a  $C_{SS}$  capacitor value of 33 nF.

## 5.6 $C_{VCC}$

The  $C_{VCC}$  capacitor is necessary to bypass an internal 2.7 V sub-regulator. This capacitor should be sized equal to or greater than 1  $\mu\text{F}$ , but less than 10  $\mu\text{F}$ . A value of 1  $\mu\text{F}$  is sufficient for most applications..

## 5.7 $C_{C1}$

The capacitor  $C_{C1}$  is used to set the crossover frequency of the LM20143 control loop. Since this board was optimized to be stable over the full input and output voltage range, the value of  $C_{C1}$  was selected to be 4.7 nF. Once the operating conditions for the device are known, the transient response can be optimized by reducing the value of  $C_{C1}$  and calculating the value for  $R_{C1}$  as outlined in [Section 5.8](#).

## 5.8 $R_{C1}$

Once the value of  $C_{C1}$  is known, resistor  $R_{C1}$  is used to place a zero in the control loop to cancel the output filter pole. This resistor can be sized according to [Equation 7](#):

$$R_{C1} = \left[ \frac{C_{C1}}{C_{OUT}} \times \left[ \frac{I_{OUT}}{V_{OUT}} + \frac{1-D}{f_{SW} \times L} + \frac{15 \times D}{V_{IN}} \right] \right]^{-1} \quad (7)$$

For stability purposes the device should be compensated for the maximum output current expected in the application.

## 5.9 $C_{C2}$

A second compensation capacitor  $C_{C2}$  can be used in some designs to provide a high frequency pole, useful for cancelling a possible zero introduced by the ESR of the output capacitor. For the LM20143 evaluation board, the  $C_{C2}$  footprint is unpopulated, as the low ESR ceramic capacitor used on the output does not contribute a zero to the control loop before the crossover frequency. If the ceramic capacitor on the evaluation board is replaced with a different capacitor having significant ESR, the required value of the capacitor  $C_{C2}$  can be estimated by [Equation 8](#):

$$C_{C2} = \frac{C_{OUT} \times R_{ESR}}{R_{C1}} \quad (8)$$

### 5.10 $R_T$

The value for  $R_T$  will set the operating frequency of the device. For this evaluation board, a value of 49.9 k $\Omega$  was chosen that sets oscillator frequency to 1.5 MHz. The value of  $R_T$  can be adjusted to support operating frequencies from 500 kHz to 1.5 MHz by using [Equation 9](#):

$$R_T = \left( \frac{154750}{f_{sw}} \right) - 55 \quad (9)$$

Where,  $f_{sw}$  is the switching frequency in kHz, and  $R_T$  is the frequency adjust resistor in k $\Omega$ .

### 5.11 $R_{FB1}$ and $R_{FB2}$

The resistors labeled  $R_{FB1}$  and  $R_{FB2}$  create a voltage divider from  $V_{OUT}$  to the feedback pin that is used to set the output of the voltage regulator. Nominally, the output of the LM20143 evaluation board is set to 1.2 V, giving resistor values of  $R_{FB1} = 4.99$  k $\Omega$  and  $R_{FB2} = 10$  k $\Omega$ . If a different output voltage is required, the value of  $R_{FB1}$  can be adjusted according to [Equation 10](#):

$$R_{FB1} = \left( \frac{V_{OUT}}{0.8} - 1 \right) \times R_{FB2} \quad (10)$$

$R_{FB2}$  does not need to be changed from its value of 10 k $\Omega$ .

## 6 PCB Layout

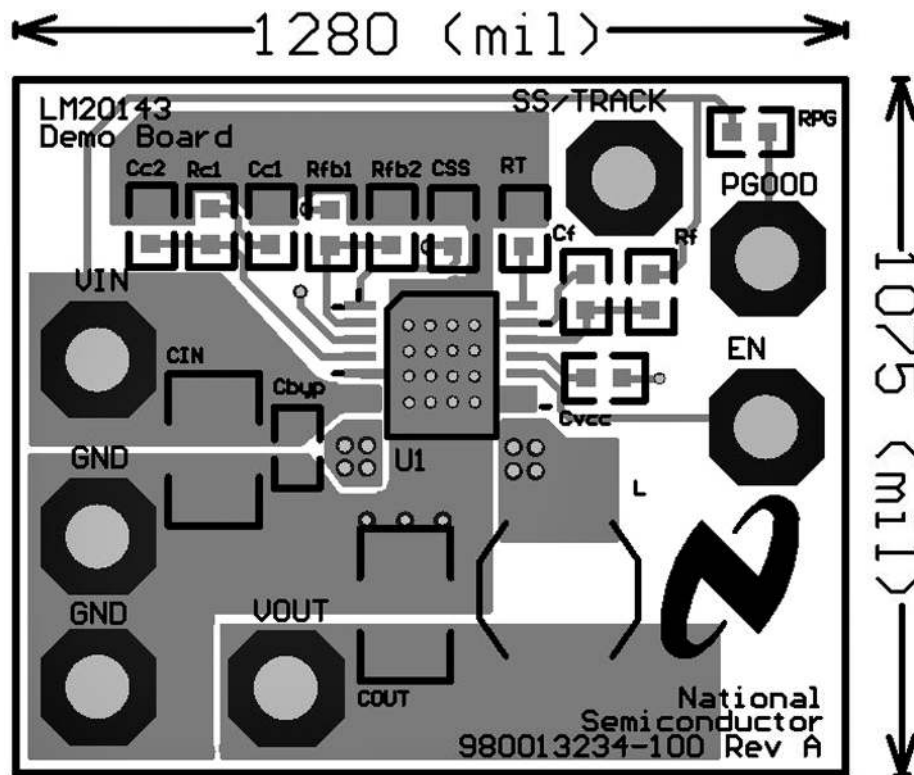

Figure 2. Top Layer

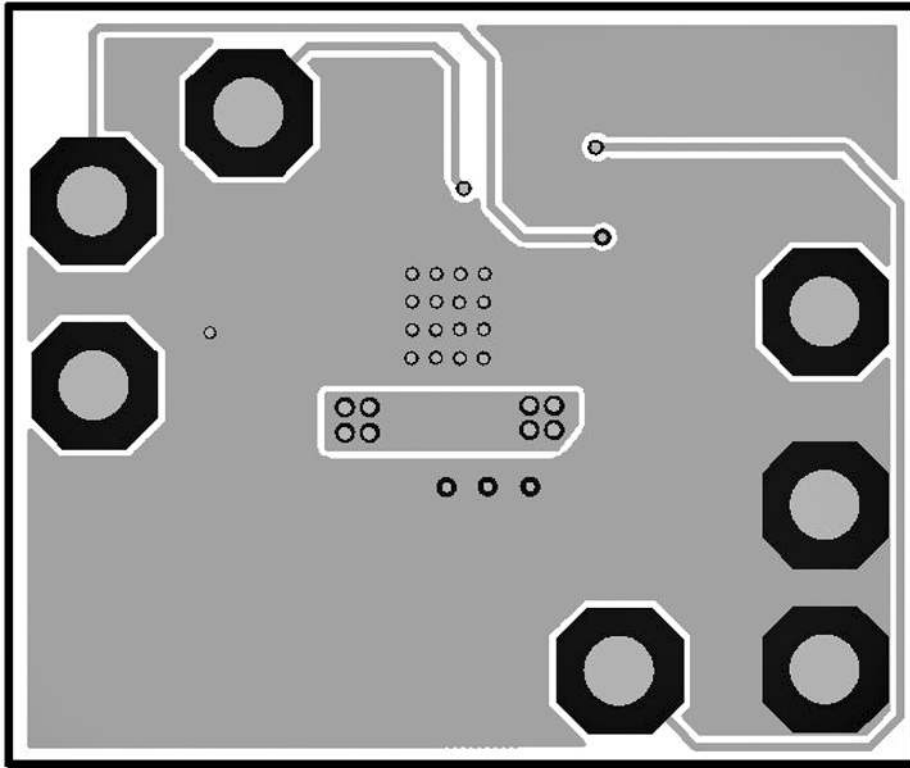

Figure 3. Bottom Layer

## IMPORTANT NOTICE

Texas Instruments Incorporated and its subsidiaries (TI) reserve the right to make corrections, enhancements, improvements and other changes to its semiconductor products and services per JESD46, latest issue, and to discontinue any product or service per JESD48, latest issue. Buyers should obtain the latest relevant information before placing orders and should verify that such information is current and complete. All semiconductor products (also referred to herein as "components") are sold subject to TI's terms and conditions of sale supplied at the time of order acknowledgment.

TI warrants performance of its components to the specifications applicable at the time of sale, in accordance with the warranty in TI's terms and conditions of sale of semiconductor products. Testing and other quality control techniques are used to the extent TI deems necessary to support this warranty. Except where mandated by applicable law, testing of all parameters of each component is not necessarily performed.

TI assumes no liability for applications assistance or the design of Buyers' products. Buyers are responsible for their products and applications using TI components. To minimize the risks associated with Buyers' products and applications, Buyers should provide adequate design and operating safeguards.

TI does not warrant or represent that any license, either express or implied, is granted under any patent right, copyright, mask work right, or other intellectual property right relating to any combination, machine, or process in which TI components or services are used. Information published by TI regarding third-party products or services does not constitute a license to use such products or services or a warranty or endorsement thereof. Use of such information may require a license from a third party under the patents or other intellectual property of the third party, or a license from TI under the patents or other intellectual property of TI.

Reproduction of significant portions of TI information in TI data books or data sheets is permissible only if reproduction is without alteration and is accompanied by all associated warranties, conditions, limitations, and notices. TI is not responsible or liable for such altered documentation. Information of third parties may be subject to additional restrictions.

Resale of TI components or services with statements different from or beyond the parameters stated by TI for that component or service voids all express and any implied warranties for the associated TI component or service and is an unfair and deceptive business practice. TI is not responsible or liable for any such statements.

Buyer acknowledges and agrees that it is solely responsible for compliance with all legal, regulatory and safety-related requirements concerning its products, and any use of TI components in its applications, notwithstanding any applications-related information or support that may be provided by TI. Buyer represents and agrees that it has all the necessary expertise to create and implement safeguards which anticipate dangerous consequences of failures, monitor failures and their consequences, lessen the likelihood of failures that might cause harm and take appropriate remedial actions. Buyer will fully indemnify TI and its representatives against any damages arising out of the use of any TI components in safety-critical applications.

In some cases, TI components may be promoted specifically to facilitate safety-related applications. With such components, TI's goal is to help enable customers to design and create their own end-product solutions that meet applicable functional safety standards and requirements. Nonetheless, such components are subject to these terms.

No TI components are authorized for use in FDA Class III (or similar life-critical medical equipment) unless authorized officers of the parties have executed a special agreement specifically governing such use.

Only those TI components which TI has specifically designated as military grade or "enhanced plastic" are designed and intended for use in military/aerospace applications or environments. Buyer acknowledges and agrees that any military or aerospace use of TI components which have **not** been so designated is solely at the Buyer's risk, and that Buyer is solely responsible for compliance with all legal and regulatory requirements in connection with such use.

TI has specifically designated certain components as meeting ISO/TS16949 requirements, mainly for automotive use. In any case of use of non-designated products, TI will not be responsible for any failure to meet ISO/TS16949.

### Products

Audio	<a href="http://www.ti.com/audio">www.ti.com/audio</a>
Amplifiers	<a href="http://amplifier.ti.com">amplifier.ti.com</a>
Data Converters	<a href="http://dataconverter.ti.com">dataconverter.ti.com</a>
DLP® Products	<a href="http://www.dlp.com">www.dlp.com</a>
DSP	<a href="http://dsp.ti.com">dsp.ti.com</a>
Clocks and Timers	<a href="http://www.ti.com/clocks">www.ti.com/clocks</a>
Interface	<a href="http://interface.ti.com">interface.ti.com</a>
Logic	<a href="http://logic.ti.com">logic.ti.com</a>
Power Mgmt	<a href="http://power.ti.com">power.ti.com</a>
Microcontrollers	<a href="http://microcontroller.ti.com">microcontroller.ti.com</a>
RFID	<a href="http://www.ti-rfid.com">www.ti-rfid.com</a>
OMAP Applications Processors	<a href="http://www.ti.com/omap">www.ti.com/omap</a>
Wireless Connectivity	<a href="http://www.ti.com/wirelessconnectivity">www.ti.com/wirelessconnectivity</a>

### Applications

Automotive and Transportation	<a href="http://www.ti.com/automotive">www.ti.com/automotive</a>
Communications and Telecom	<a href="http://www.ti.com/communications">www.ti.com/communications</a>
Computers and Peripherals	<a href="http://www.ti.com/computers">www.ti.com/computers</a>
Consumer Electronics	<a href="http://www.ti.com/consumer-apps">www.ti.com/consumer-apps</a>
Energy and Lighting	<a href="http://www.ti.com/energy">www.ti.com/energy</a>
Industrial	<a href="http://www.ti.com/industrial">www.ti.com/industrial</a>
Medical	<a href="http://www.ti.com/medical">www.ti.com/medical</a>
Security	<a href="http://www.ti.com/security">www.ti.com/security</a>
Space, Avionics and Defense	<a href="http://www.ti.com/space-avionics-defense">www.ti.com/space-avionics-defense</a>
Video and Imaging	<a href="http://www.ti.com/video">www.ti.com/video</a>

### TI E2E Community

[e2e.ti.com](http://e2e.ti.com)