

SMD Wire Wound Ceramic Chip Inductors IWC0402 Series

APPLICATIONS

Resonant circuits, impedance matching for

- Antenna amplifiers
- Multimedia
- Wireless communication systems

FEATURES

- High resonance frequency
- Narrow inductance tolerance
- Suitable for lead-free reflow soldering
- RoHS-compatible

MATERIAL LIST

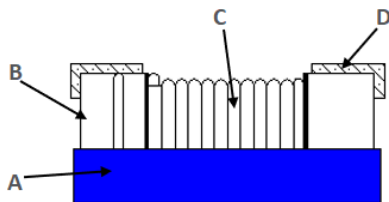

- (A) Epoxy
- (B) Ceramic
- (C) Wire
- (D) Terminal

Part Numbering

IWC	0402	D	24N	R	-3□
Product Series Code	Size Code	Rated Current Code	Inductance Value Code	Packing Code R-Tape&Reel	Additional Description
		A ≤ 100mA B=200mA C=300mA D=400mA E=500mA F=600mA G=700mA H=800mA I=900mA	0N3=0.3nH 6N8=6.8nH 24N=24nH R10=100nH		□-Tolerance Code G - ±2% J - ±5%

Notes

Standard testing conditions , unless otherwise specified

- Temperature: 15 °C to 35°C
- Humidity: 25% to 85% (RH)
- L、 Q、 SRF : Agilent E4991A+ Agilent 16197A
- Operating Temperature: -40 °C to +125 °C
- Storage Temperature: -10 °C to +40 °C
- Products should be used within 12 months, from the time of delivery
- Cosmetic specification refer to WI-QA-124

1.SPECIFICATION

Part Number	L (nH)	Tolerance	L Test Fre (MHz)	Q Min	Q Test Fre (MHz)	DCR Max (Ω)	Rated current (mA)	SRF (MHz)
IWC0402D22NR-3G	22	$\pm 2\%$	250	25	250	0.3	400	2800
IWC0402D22NR-3J	22	$\pm 5\%$	250	25	250	0.3	400	2800
IWC0402D27NR-3G	27	$\pm 2\%$	250	24	250	0.4	400	2480
IWC0402D27NR-3J	27	$\pm 5\%$	250	24	250	0.4	400	2480
IWC0402D33NR-3G	33	$\pm 2\%$	250	24	250	0.45	400	2350
IWC0402D33NR-3J	33	$\pm 5\%$	250	24	250	0.45	400	2350
IWC0402B39NR-3G	39	$\pm 2\%$	250	25	250	0.55	200	2100
IWC0402B39NR-3J	39	$\pm 5\%$	250	25	250	0.55	200	2100
IWC0402A47NR-3G	47	$\pm 2\%$	250	20	250	0.83	150	2100
IWC0402A47NR-3J	47	$\pm 5\%$	250	20	250	0.83	150	2100
IWC0402A68NR-3G	68	$\pm 2\%$	250	22	250	1.12	100	1620
IWC0402A68NR-3J	68	$\pm 5\%$	250	22	250	1.12	100	1620
IWC0402A82NR-3G	82	$\pm 2\%$	250	20	250	1.55	50	1230
IWC0402A82NR-3J	82	$\pm 5\%$	250	20	250	1.55	50	1230
IWC0402AR10R-3G	100	$\pm 2\%$	250	20	250	2	30	1160
IWC0402AR10R-3J	100	$\pm 5\%$	250	20	250	2	30	1160
IWC0402AR12R-3G	120	$\pm 2\%$	100	20	100	2.66	110	1000
IWC0402AR12R-3J	120	$\pm 5\%$	100	20	100	2.66	110	1000

2.Dimensions

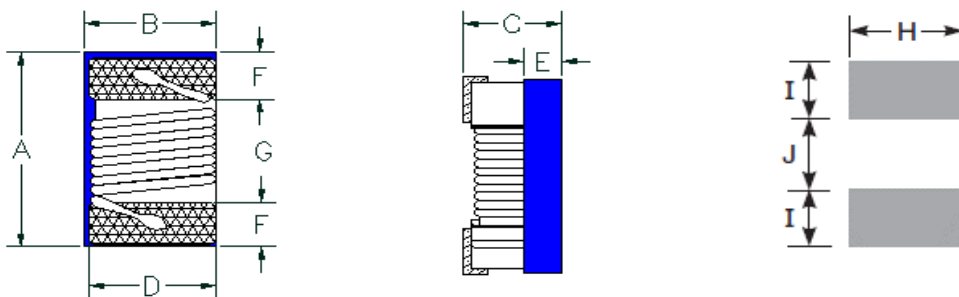

A Max	B Max	C Max	D Ref	E Ref	F Ref	G Ref	H Ref	I Ref	J Ref
1.19	0.7	0.66	0.51	0.25	0.23	0.56	0.66	0.36	0.46

3.CURVES

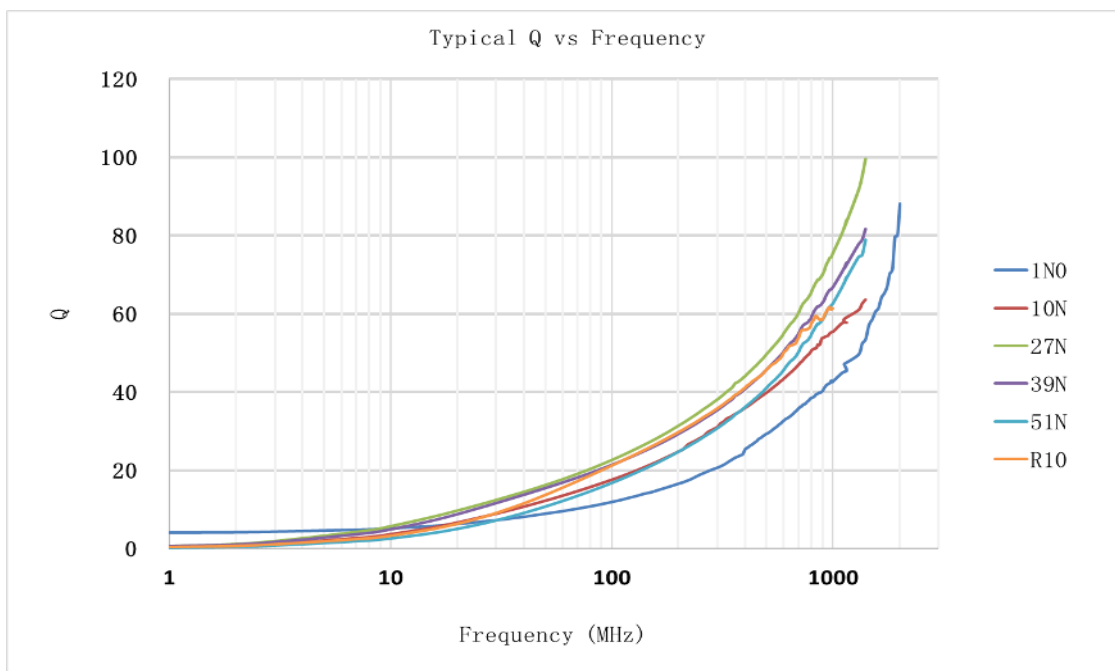
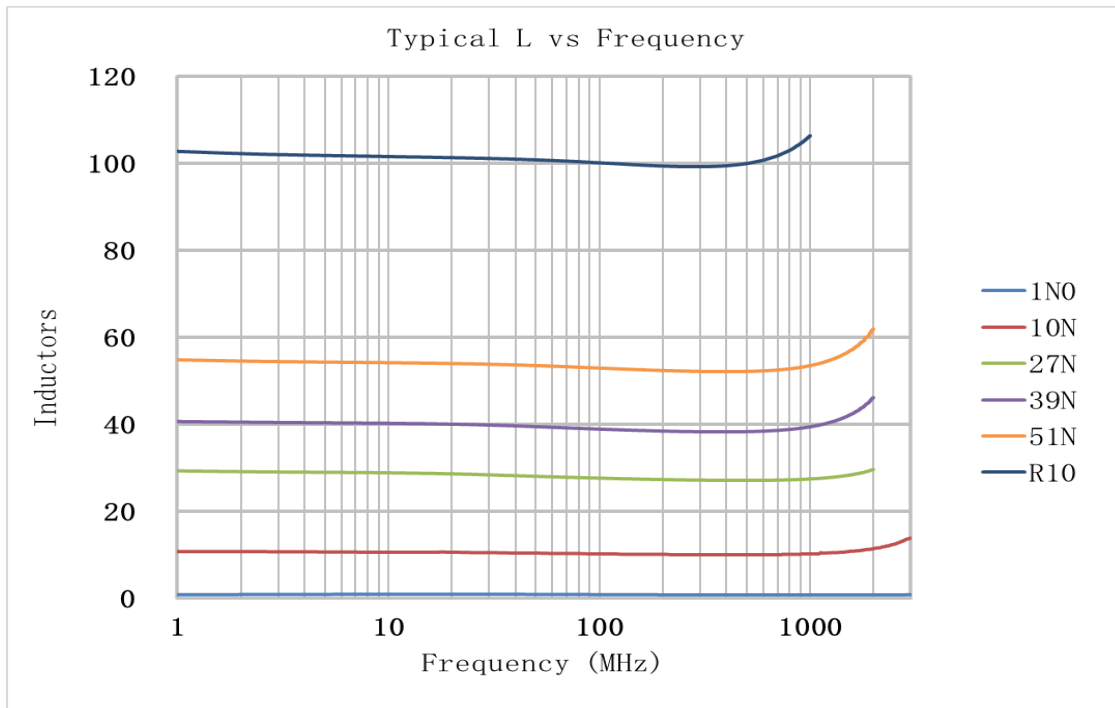

4. SOLDERING

Typical RoHS Reflow Profile

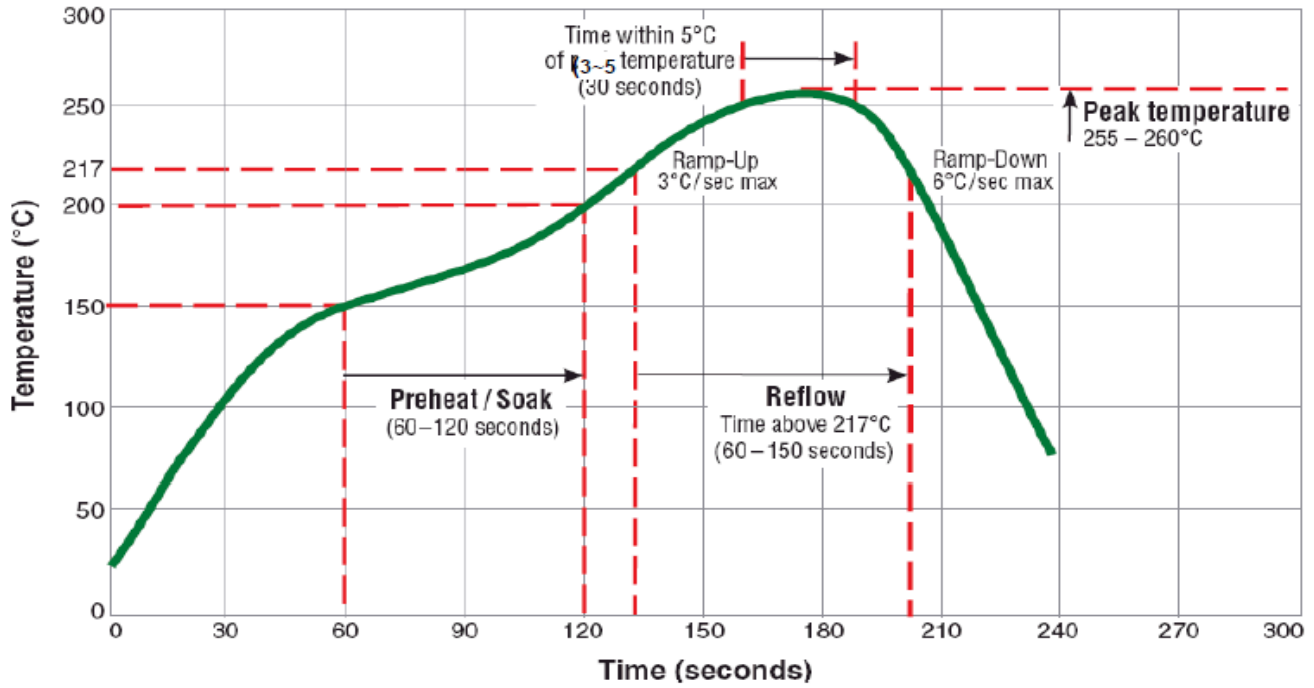

5. PACKAGING

Packaging Style and Quantity

Laird Part Number	Packaging Type	Reel Quantity	Inner box Quantity
IWC0402 Series	Tape & Reel	4000	20000

Taping Condition (Typ)

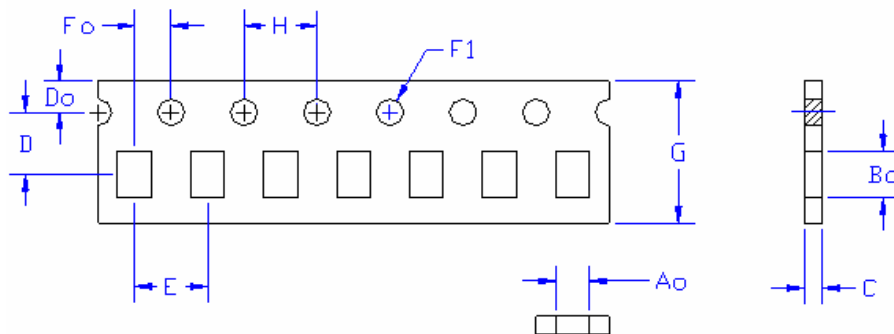

Ao	Bo	C	D	Do
0.78	1.35	0.75	3.5	1.75
E	Fo	F1	G	H
4	2	1.5	81	4

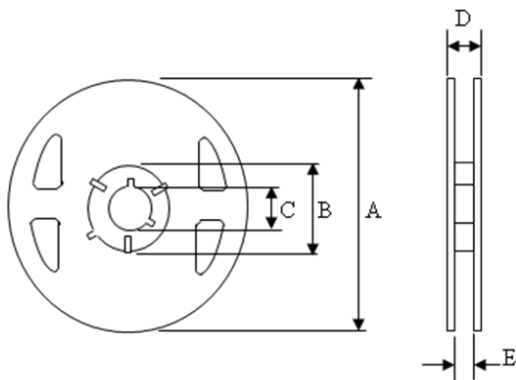

Reel Specifications (Typ)	
A	180
B	60
C	13
D	14.4
E	8.4

Tape Strength

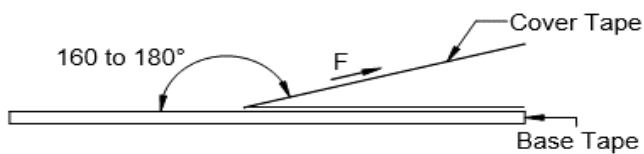

Tape Width	Peeling Force
8 mm	0.1N to 0.6N

6.RELIABILITY

No	Stress	Reference	Additional Requirements
1	High Temperature Exposure (Storage)	MIL-STD-202 Method 108	85±2°C, 168+24hours Inductance:within±10% of initial value
2	Temperature Cycling	JESD22 Method JA-104	-40°C~+85°C, 100cycles Inductance:within±10% of initial value
3	Operational Life	MIL-PRF-27	85°C(Including self-heating), 168hrs, rated current applied(as the part drawing). Inductance:within±10% of initial value
4	External Visual	MIL-STD-883 Method 2009	Inspect device construction, marking and workmanship. Electrical Test not required.
5	Physical Dimension	JESD22 Method JB-100	Verify physical dimensions to the applicable device detail specification. Note: User(s) and Suppliers spec. Electrical Test not required.
6	Vibration	MIL-STD-202 Method 204	10~55Hz,1.5mm,2 hours in each 3mutually perpendicular directions,(total of 6 hours) Inductance:within±10% of initial value
7	Resistance to Soldering Heat	MIL-STD-202 Method 210	1. Max. 260±5°C,10±1s, 2 times 2.Solder Composition: Sn/3Ag/0.5Cu
8	Solderability	J-STD-002	245±5°C, 5±1sec, Solder: Sn/3.0Ag/0.5Cu
9	Electrical Characterization	User Spec.	Parametrically test per lot and sample size requirements, summary to show Min, Max, Mean and Standard deviation at room as well as Min and Max Operating temperatures.
10	Board Flex	AEC-Q200-005	2mm(min), Dwell:30±1 sec.
11	Terminal Strength	AEC-Q200-006	Force:≥2.94N, Dwell:5+1 sec, X, Y direct