

MC10160

12-Bit Parity Generator-Checker

The MC10160 consists of nine Exclusive-OR gates in a single package, internally connected to provide odd parity checking or generation. Output goes high when an odd number of inputs are high. Unconnected inputs are pulled to low logic levels allowing parity detection and generation for less than 12 bits.

- $P_D = 320 \text{ mW typ/pkg (No Load)}$
- $t_{pd} = 5.0 \text{ ns typ}$
- $t_r, t_f = 2.0 \text{ ns typ (20\%–80\%)}$

LOGIC DIAGRAM

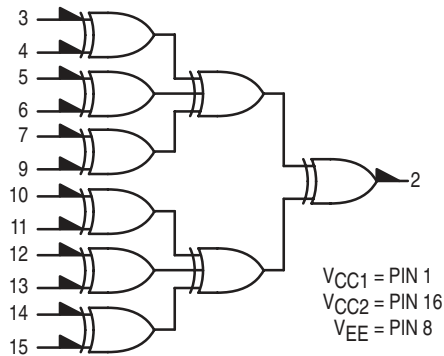

DIP PIN ASSIGNMENT

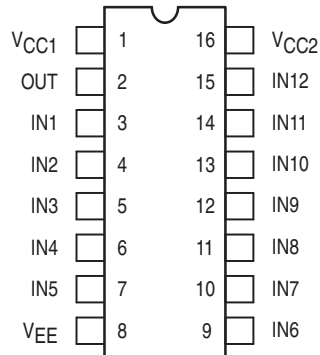

Pin assignment is for Dual-in-Line Package.
For PLCC pin assignment, see the Pin Conversion Tables on page 18.

| INPUT | OUTPUT |
|--------------------------|--------|
| Sum of High Level Inputs | Pin 2 |
| Even | Low |
| Odd | High |



ON Semiconductor

<http://onsemi.com>

MARKING DIAGRAMS

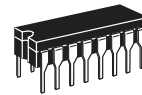

CDIP-16
L SUFFIX
CASE 620

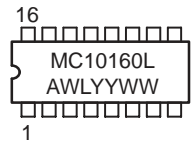

PDIP-16
P SUFFIX
CASE 648

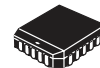
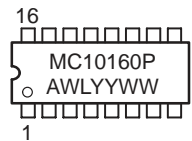

PLCC-20
FN SUFFIX
CASE 775

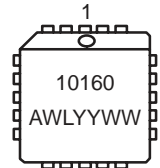

A = Assembly Location
WL = Wafer Lot
YY = Year
WW = Work Week

ORDERING INFORMATION

| Device | Package | Shipping |
|-----------|---------|-----------------|
| MC10160L | CDIP-16 | 25 Units / Rail |
| MC10160P | PDIP-16 | 25 Units / Rail |
| MC10160FN | PLCC-20 | 46 Units / Rail |

MC10160

ELECTRICAL CHARACTERISTICS

| Characteristic | Symbol | Pin Under Test | Test Limits | | | | | | Unit | |
|------------------------------------|------------------------|----------------|-------------|--------|--------|-----|--------|--------|--------|-----------|
| | | | -30°C | | +25°C | | +85°C | | | |
| | | | Min | Max | Min | Typ | Max | Min | | Max |
| Power Supply Drain Current | I_E | 8 | | 86 | | 62 | 78 | | 86 | mAdc |
| Input Current | I_{inH} (Note 1.) | 3 | | 425 | | | 265 | | 265 | μ Adc |
| | | 4 | | 350 | | | 220 | | 220 | μ Adc |
| | I_{inL} | 3 | 0.5 | | 0.5 | | | 0.3 | | μ Adc |
| Output Voltage Logic 1 | V_{OH} | 2 | -1.060 | -0.890 | -0.960 | | -0.810 | -0.890 | -0.700 | Vdc |
| Output Voltage Logic 0 | V_{OL} | 2 | -1.890 | -1.675 | -1.850 | | -1.650 | -1.825 | -1.615 | Vdc |
| Threshold Voltage Logic 1 | V_{OHA} | 2 | -1.080 | | -0.980 | | | -0.910 | | Vdc |
| Threshold Voltage Logic 0 | V_{OLA} | 2 | | -1.655 | | | -1.630 | | -1.595 | Vdc |
| Switching Times (50 Ω Load) | | | | | | | | | | ns |
| Propagation Delay | t_{3+2+} | 2 | 1.8 | 8.1 | 2.0 | 5.0 | 7.5 | 2.0 | 8.0 | |
| | t_{3+2-} | 2 | 1.8 | 8.1 | 2.0 | 5.0 | 7.5 | 2.0 | 8.0 | |
| | t_{3-2-} | 2 | 1.8 | 8.1 | 2.0 | 5.0 | 7.5 | 2.0 | 8.0 | |
| | t_{3-2+} | 2 | 1.8 | 8.1 | 2.0 | 5.0 | 7.5 | 2.0 | 8.0 | |
| | t_{4+2+} | 2 | 1.8 | 8.1 | 2.0 | 5.0 | 7.5 | 2.0 | 8.0 | |
| | t_{4+2-} | 2 | 1.8 | 8.1 | 2.0 | 5.0 | 7.5 | 2.0 | 8.0 | |
| | t_{4-2-} | 2 | 1.8 | 8.1 | 2.0 | 5.0 | 7.5 | 2.0 | 8.0 | |
| | t_{4-2+} | 2 | 1.8 | 8.1 | 2.0 | 5.0 | 7.5 | 2.0 | 8.0 | |
| Rise Time (20 to 80%) | t_{2+} | 2 | 1.1 | 3.5 | 1.1 | 2.0 | 3.3 | 1.0 | 3.5 | |
| Fall Time (20 to 80%) | t_{2-} | 2 | 1.1 | 3.5 | 1.1 | 2.0 | 3.3 | 1.0 | 3.5 | |

1. Pins 3, 6, 7, 11, 12, 15 are similar. Pins 4, 5, 9, 10, 13, 14 are similar.

MC10160

ELECTRICAL CHARACTERISTICS (continued)

| | | | TEST VOLTAGE VALUES (Volts) | | | | | (V _{CC}) Gnd |
|----------------------------|-------------------------------|----------------|---|-------------------------------|---------------------|---------------------|-----------------|---------------------------|
| | | | V _{IHmax} | V _{ILmin} | V _{IHAmin} | V _{ILAmax} | V _{EE} | |
| @ Test Temperature | | | | | | | | |
| -30°C | | | -0.890 | -1.890 | -1.205 | -1.500 | -5.2 | |
| +25°C | | | -0.810 | -1.850 | -1.105 | -1.475 | -5.2 | |
| +85°C | | | -0.700 | -1.825 | -1.035 | -1.440 | -5.2 | |
| Characteristic | Symbol | Pin Under Test | TEST VOLTAGE APPLIED TO PINS LISTED BELOW | | | | | |
| | | | V _{IHmax} | V _{ILmin} | V _{IHAmin} | V _{ILAmax} | V _{EE} | |
| Power Supply Drain Current | I _E | 8 | 4,5,9,10,13,14 | | | | 8 | 1,16 |
| Input Current | I _{inH} (Note 1.) | 3 | 3 | | | | 8 | 1,16 |
| | | 4 | 4 | | | | 8 | 1,16 |
| | I _{inL} | 3 | | 3 | | | 8 | 1,16 |
| Output Voltage Logic 1 | V _{OH} | 2 | 3 | 4,5,6,7,9,10,11,12,13,14,15 | | | 8 | 1,16 |
| Output Voltage Logic 0 | V _{OL} | 2 | | 3,4,5,6,7,9,10,11,12,13,14,15 | | | 8 | 1,16 |
| Threshold Voltage Logic 1 | V _{OHA} | 2 | | 4,5,6,7,9,10,11,12,13,14,15 | 3 | | 8 | 1,16 |
| Threshold Voltage Logic 0 | V _{OLA} | 2 | | 3,5,6,7,9,10,11,12,13,14,15 | | 4 | 8 | 1,16 |
| Switching Times (50Ω Load) | | | +1.11V | | Pulse In | Pulse Out | -3.2 V | +2.0 V |
| Propagation Delay | t ₃₊₂₊ | 2 | | | 3 | 2 | 8 | 1,16 |
| | t ₃₊₂₋ | 2 | 4 | | 3 | 2 | 8 | 1,16 |
| | t ₃₋₂₋ | 2 | | | 3 | 2 | 8 | 1,16 |
| | t ₃₋₂₊ | 2 | 4 | | 3 | 2 | 8 | 1,16 |
| | t ₄₊₂₊ | 2 | | | 4 | 2 | 8 | 1,16 |
| | t ₄₊₂₋ | 2 | 3 | | 4 | 2 | 8 | 1,16 |
| | t ₄₋₂₋ | 2 | | | 4 | 2 | 8 | 1,16 |
| | t ₄₋₂₊ | 2 | 3 | | 4 | 2 | 8 | 1,16 |
| Rise Time (20 to 80%) | t ₂₊ | 2 | | | 3 | 2 | 8 | 1,16 |
| Fall Time (20 to 80%) | t ₂₋ | 2 | | | 3 | 2 | 8 | 1,16 |

1. Pins 3, 6, 7, 11, 12, 15 are similar. Pins 4, 5, 9, 10, 13, 14 are similar.

Each MECL 10,000 series circuit has been designed to meet the dc specifications shown in the test table, after thermal equilibrium has been established. The circuit is in a test socket or mounted on a printed circuit board and transverse air flow greater than 500 linear fpm is maintained. Outputs are terminated through a 50-ohm resistor to -2.0 volts. Test procedures are shown for only one gate. The other gates are tested in the same manner.