

QT-Brightek PLCC-6 Series

PLCC6 LED

Part No.: QBLP679-XXK

Table of Contents:

Introduction	3
Electrical / Optical Characteristic (Ta=25 °C)	4
Absolute Maximum Rating	4
Characteristic Curves.....	7
Solder Profile & Footprint.....	9
Packing	10
Labeling	11
Ordering Information	11
Revision History	12
Disclaimer	12

Introduction

Feature:

- Package in tape and reel
- Ultra bright PLCC6
- InGaN technology for IB/IG
- AlInGaP technology for R/Y/O/S
- 120 degree viewing angle

Description:

This PLCC6 LEDs have a height profile of 1.60mm. Combination of high brightness output and robust package, this LED is ideal for architecture lighting, status indication, and general application.

Application:

- Status indication
- Industrial equipment backlighting
- Architecture lighting

Certification & Compliance:

- TS16949
- ISO9001
- RoHS Compliant



Dimension:

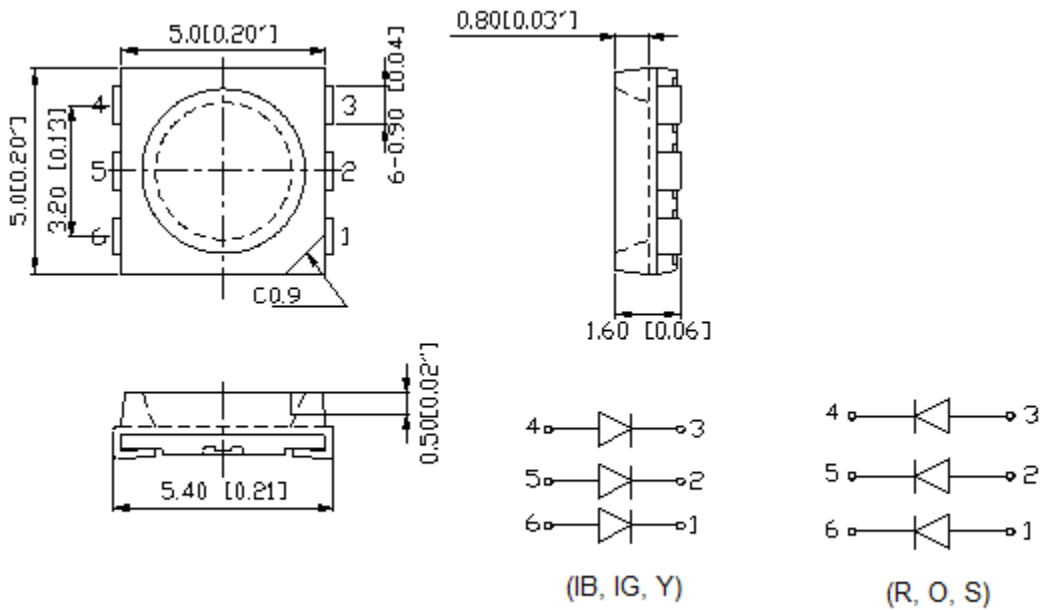

Units: mm / tolerance = +/-0.2mm

Electrical / Optical Characteristic (Ta=25 °C)

Product	Color	I _F (mA)*	V _F (V)		λ _D (nm)			I _V (mcd)	
			Typ.	Max.	Min.	Typ.	Max.	Min.	Typ.
QBLP679-IBK	Blue	60	3.3	3.7	462.5	467	472.5	780	1100
QBLP679-IGK	True Green	60	3.3	3.7	520	525	535	3600	4700
QBLP679-RK	Red	60	2.0	2.5	620	625	630	350	630
QBLP679-YK	Yellow	60	2.0	2.5	585	590	595	1250	1600
QBLP679-OK	Orange	60	2.0	2.5	600	605	610	350	780
QBLP679-SK	Deep Red	60	2.0	2.5	630	640	650	125	220

*Total forward current for three dies

Absolute Maximum Rating

Material	P _d (mW)	I _F (mA)	I _{FP} (mA)*	V _R (V)	T _{OP} (°C)	T _{ST} (°C)	T _{SO L} (°C)**	ESD (V)
InGaN (IB/IG)	333	90	125	5	-40 ~ +80	-40 ~ +85	260	HBM 2000
AllnGaP (R/Y/O/S)	225	90	125	5	-40 ~ +80	-40 ~ +85	260	HBM 8000

*Duty 1/8 @ 1KHz

**IR Reflow for no more than 10 sec @ 260 °C

Forward Voltage V_F for AllnGaP @ I_F=60mA

Bin	Min.	Max.	Unit
□	1.7	2.5	V

Forward Voltage V_F for InGaN @ I_F=60mA

Bin	Min.	Max.	Unit
f	2.8	3.1	V
g	3.1	3.4	
h	3.4	3.7	

Luminous Intensity I_V for Blue @ $I_F=60\text{mA}$

Bin	Min.	Max.
14	780	1000
15	1000	1300

Luminous Intensity I_V for True Green @ $I_F=60\text{mA}$

Bin	Min.	Max.
20	3600	4600
21	4600	6000

Luminous Intensity I_V for Red @ $I_F=60\text{mA}$

Bin	Min.	Max.
11	350	460
12	460	600
13	600	780
14	780	1000
15	1000	1300

Luminous Intensity I_V for Yellow @ $I_F=60\text{mA}$

Bin	Min.	Max.
U	1250	1600
V	1600	2000
W	2000	2500

Luminous Intensity I_V for Orange @ $I_F=60\text{mA}$

Bin	Min.	Max.
11	350	460
12	460	600
13	600	780
14	780	1000
15	1000	1300

Luminous Intensity I_V for Deep Red @ $I_F=60\text{mA}$

Bin	Min.	Max.
K	125	160
L	160	200
M	200	250
N	250	320
O	320	400

Dominant Wavelength λ_D for Blue @ $I_F=60\text{mA}$

Bin	Min.	Max.	Unit
D	462.5	467.5	nm
E	467.5	472.5	

Dominant Wavelength λ_D for True Green @ $I_F=60\text{mA}$

Bin	Min.	Max.	Unit
G	520	525	nm
H	525	530	
I	530	535	

Dominant Wavelength λ_D for Red @ $I_F=60\text{mA}$

Bin	Min.	Max.	Unit
C	620	625	nm
D	625	630	

Dominant Wavelength λ_D for Yellow @ $I_F=60\text{mA}$

Bin	Min.	Max.	Unit
m	585	590	nm
n	590	595	

Dominant Wavelength λ_D for Orange @ $I_F=60\text{mA}$

Bin	Min.	Max.	Unit
p	600	605	nm
q	605	610	

Dominant Wavelength λ_D for Deep Red @ $I_F=60\text{mA}$

Bin	Min.	Max.	Unit
v	630	635	nm
w	635	650	

Note:

Tolerance of measurement of forward voltage: $\pm 0.05\text{V}$ Tolerance of measurement of luminous intensity: $\pm 15\%$ Tolerance of measurement of dominant wavelength: $\pm 1\text{nm}$

Characteristic Curves

AllnGaP(R/Y/O/S)

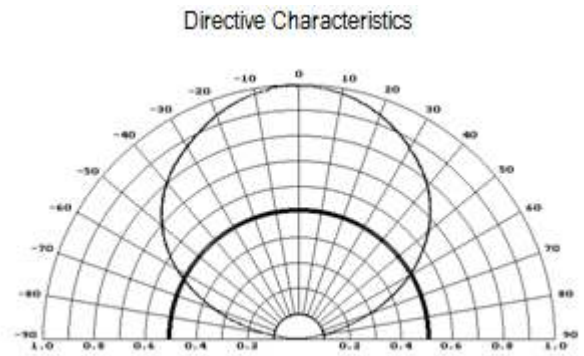
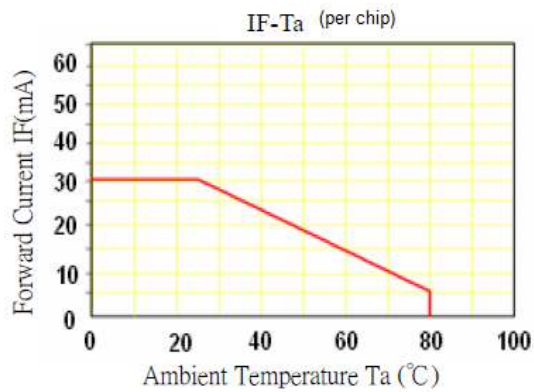
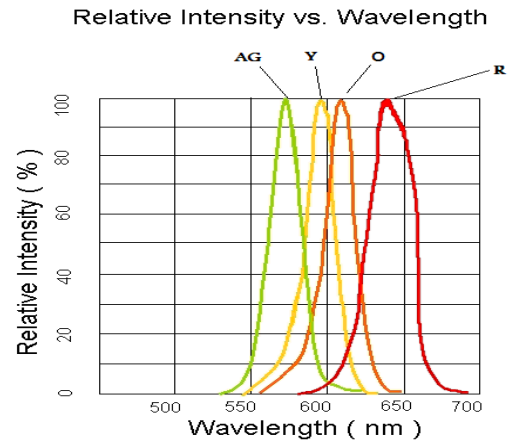
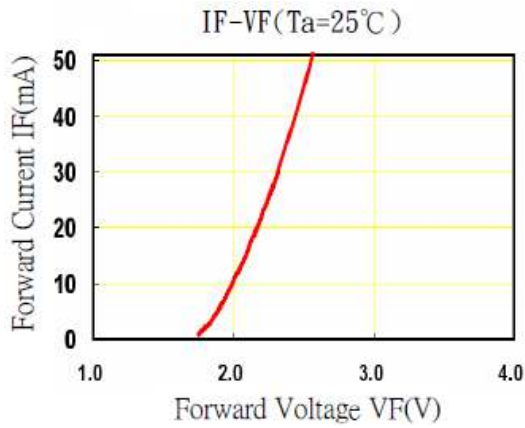

InGaN (IB/IG)

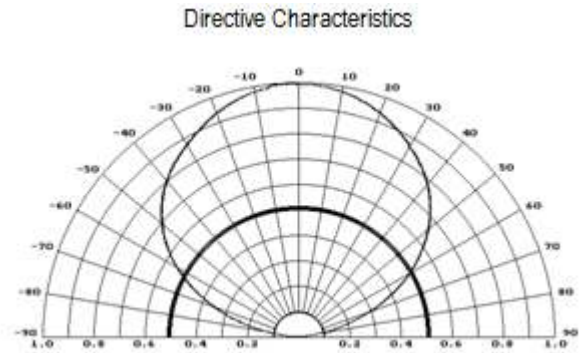
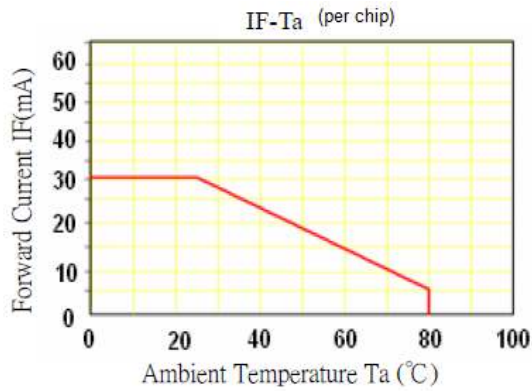
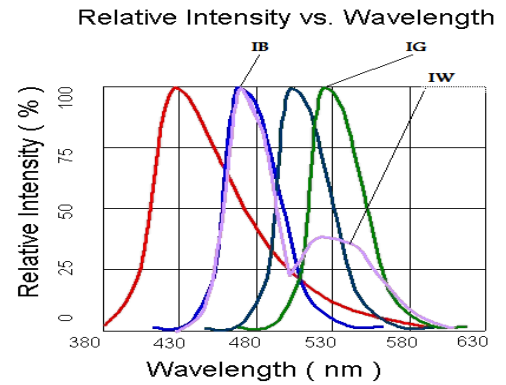
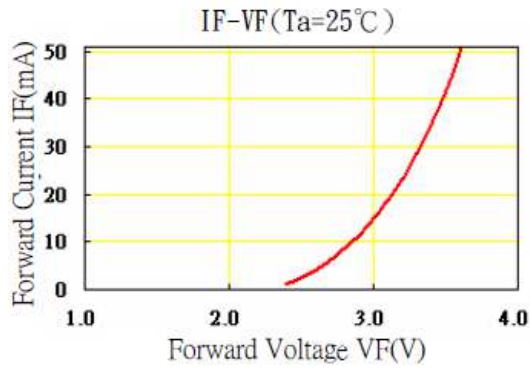

Solder Profile & Footprint

- Recommended tin solder specifications: melting temperature in the range of 178~192 °C
- The recommended reflow soldering profile is as follows (temperatures indicated are as measured on the surface of the LED resin):

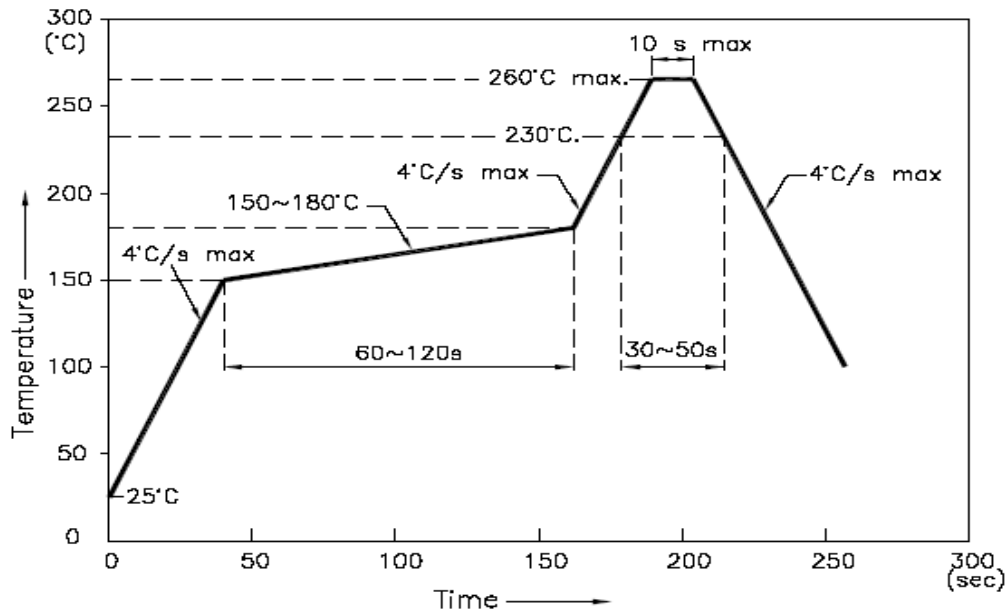

RECOMMEND PAD LAYOUT

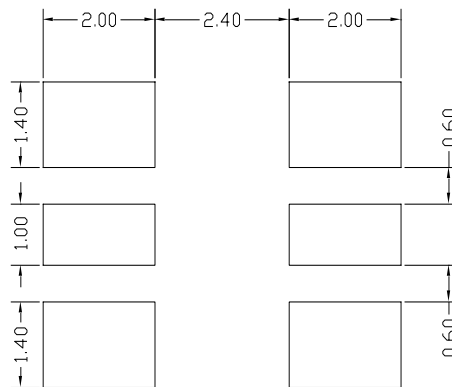

Units: mm

tolerance: +/- 0.2mm

Packing

Reel Dimension:

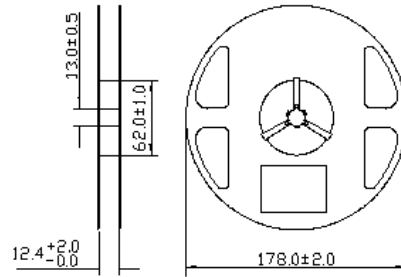

Unit: mm

Tape Dimension:

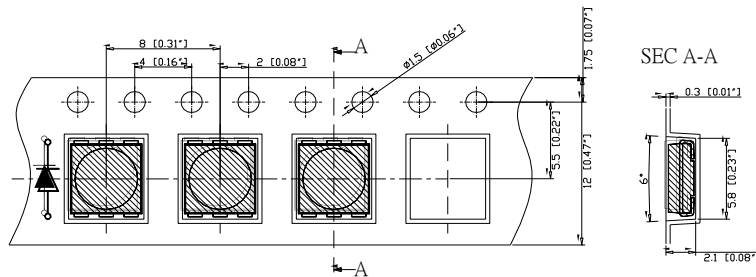

Unit: mm

Arrangement of Tape:

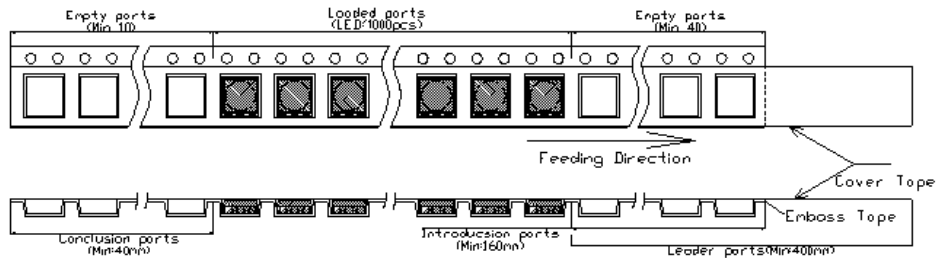

Packaging Specifications:

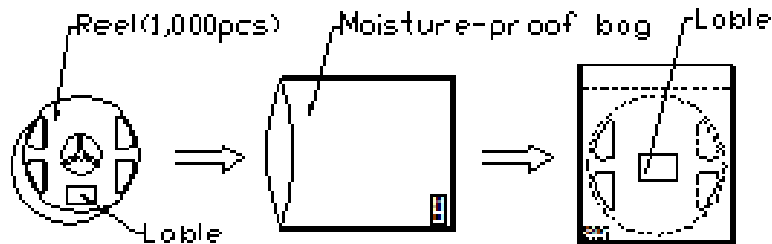

Labeling



Part No: _____
 Customer P/N: _____
 Item: _____
 Q'ty: _____
 Vf: _____
 Iv: _____
 VI: _____
 Date: _____

Made in China

Ordering Information

Part #	Orderable Part #	Spec Range	Quantity per reel
QBLP679-IBK	QBLP679-IBK	Iv=1100mcd typ. @ 60mA / Color=462.5-472.5nm	1,000 units
QBLP679-IGK	QBLP679-IGK	Iv=4700mcd typ. @ 60mA / Color=520-535nm	1,000 units
QBLP679-RK	QBLP679-RK	Iv=630mcd typ. @ 60mA / Color=620-630nm	1,000 units
QBLP679-YK	QBLP679-YK	Iv=1600mcd typ. @ 60mA / Color=585-595nm	1,000 units
QBLP679-OK	QBLP679-OK	Iv=780mcd typ. @ 60mA/ Color=600-615nm	1,000 units
QBLP679-SK	QBLP679-SK	Iv =220mcd typ. @ 60mA/ Color=630-650nm	1,000 units

Revision History

Description:	Revision #	Revision Date
New Release of QBLP679-XXK_series	V1.0	02/13/2012
New format/ Add the "Deep Red" spec / Amend the brightness for InGaN blue and InGaN Green	V1.1	06/25/2013
Add ESD HBM information	V1.2	08/12/2013
Update package dimension and spec	V2.0	03/27/2014

Disclaimer

QT-BRIGHTTEK reserves the right to make changes without further notice to any products herein to improve reliability, function or design. QT-BRIGHTTEK does not assume any liability arising out of the application or use of any product or circuit described herein; neither does it convey any license under its patent rights, nor the rights of others.

Life Support Policy

QT-BRIGHTTEK's products are not authorized for use as critical components in life support devices or systems without the express written approval of QT-BRIGHTTEK. As used herein:

1. Life support devices or systems are devices or systems which, (a) are intended for surgical implant into the body, or (b) support or sustain life, and (c) whose failure to perform when properly used in accordance with instructions for use provided in the labeling, can be reasonably expected to result in a significant injury of the user.
2. A critical component in any component of a life support device or system whose failure to perform can be reasonably expected to cause the failure of the life support device or system, or to affect its safety or effectiveness.