

SL10.100

- Input: AC 230/115V, DC 240...375V
- Output: 24-28V/240W
- Power boost up to 288W
- High overload current, no switch-off
- Robust mechanics and EMC

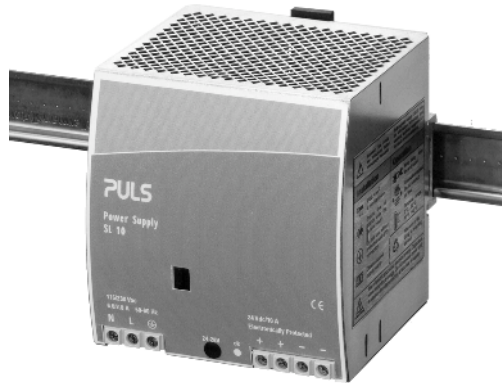

Input

Input voltage	AC 100-120/220-240V (switchable), 47-63Hz (AC 85...132/176...264V, DC 240...375V)
Note:	At DC input, always leave the switch in the 230V position
Input current	<6A (switch in 115V position) <2.6A (switch in 230V position)
DCin at open output	8mA (preserves battery sources)
Inrush current	typ. <30A at AC 264V and cold start
Unit is internally fused (fuse not accessible). For external fusing of unit and for input line protection, use circuit breaker with B-characteristic 10A or slower action, or alternatively T10A HBC fuse.	
Transient handling	Transient resistance acc. to VDE 0160 / W2 (750V/1.3ms), for all load conditions.
Hold up time	>25ms at AC 196V, 24V/10A (see diagram overleaf)

Efficiency, Reliability etc.*

Efficiency	typ. 90% (AC 230V, 24V/10A)
Losses	typ. 26.7W (AC 230V, 24V/10A)
MTBF	425.000h acc. to Siemensnorm SN 29500 (24V/10A, AC 230V, Tamb = +40°C)
Life cycle (electrolytics)	The unit exclusively uses longlife electrolytics, specified for +105°C (cf. 'The SilverLine', p.2).

Start / Overload Behaviour

Startup delay	typ. 0.1s
Rise time	ca. 5-20ms, depending on load
Overload Behaviour	<ul style="list-style-type: none"> • Special PULS Overload Design (see diagram overleaf) • 20% power boost

– no disconnection, no hiccup if overloaded
– high overload current (up to 1.6 INom), Vout is gradually reduced with increasing current.
– 12A short-term, at 45°C or forced cooling even continuous

Advantages:

- High short-circuit current, giving large 'start-up window': unit starts reliably even with awkward loads (DC-DC converters, motors).
- No 'sticking' such as can occur with fold-back characteristics
- Secondary fuses operate more reliably

* For further information see data sheets „The SilverLine“, „SilverLine Family Branches“ and mechanics data sheet

Order information

Order number	Description
SL10.100	Basic version*
SLR10.100	N+1 redundancy*
SLS10.100	Safety Cover*
SLZ02	Screw mounting set, two needed per unit

Output

Output voltage	DC 24-28V, adjustable by (covered) front panel potentiometer; preset: 24.5V ±0.5% Adj. range guaranteed
Output noise suppression	Radiated EMI values below EN 61000-6-3, even when using long, unscreened output cables.
Ambient temperature range Tamb	Operation: 0°C...+70°C (>60°C: Derating) Storage: -25°C...+85°C
Rated continuous loading with convection cooling	<ul style="list-style-type: none"> • Tamb=0°C - 60°C 24V/10A (240W) resp. 28V/8.6A (240W) • Tamb=0°C - 45°C 24V/12A (288W) resp. 28V/10.3A (288W) short-term also at 60°C
Output is protected against short-circuit, open circuit and overload	
Derating	typ. 6W/K (at Tamb= +60°C...+70°C)
Voltage regulation	better than 2% Vout overall
Ripple / Noise	<30mVPP, (20MHz bandw., 50W measurement)
Overvolt. protection	typ. 35V
Parallel operation	yes, load sharing available on request
Power back immunity	34V
Front panel indicator	Green LED on front panel

Construction / Mechanics*

Housing dimensions and Weight	
<ul style="list-style-type: none"> • W x H x D • Free space for ventilation • Weight 	120mm x 124mm x 102mm (+ DIN rail) above/below 25mm recommended left/right 15mm recommended 980g
Design advantages:	
<ul style="list-style-type: none"> • All connection blocks are easy to reach as mounted at the front panel. 	

Functional diagrams

Efficiency (typ.)

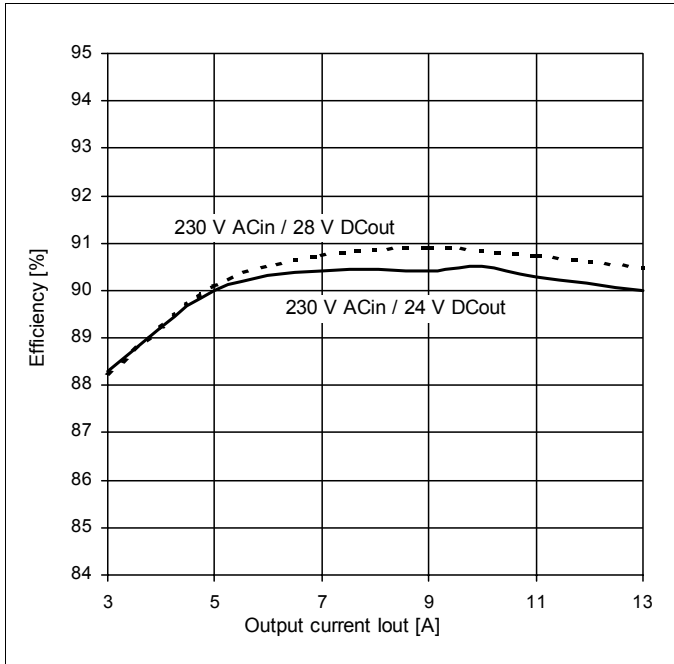

Output characteristic (min.)

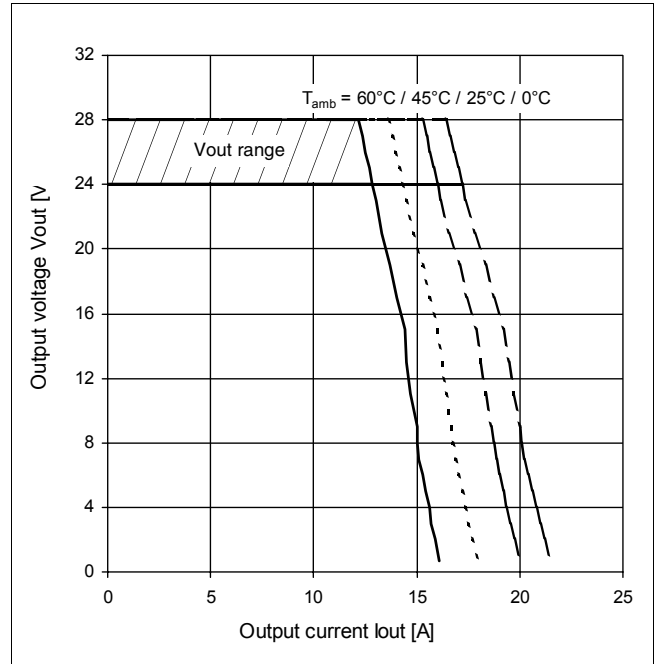

Hold-up time (typ., at Vout=24V)

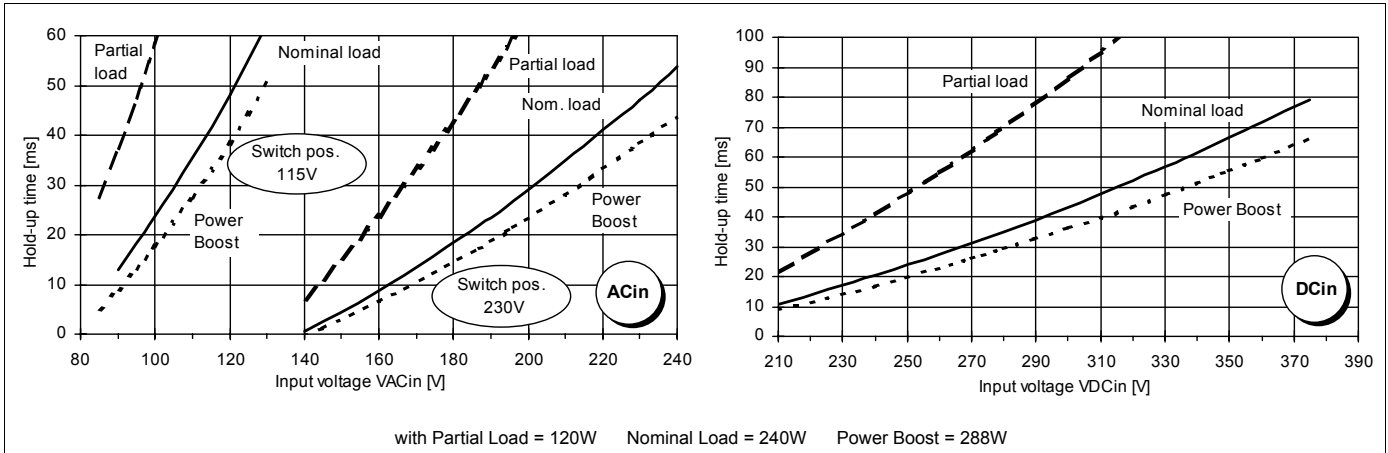

For further information, especially about

- EMC
 - Connections
 - Safety, Approvals
 - Mechanics und Mounting,
- see page 2 of the „The SilverLine“ data sheet.

For detailed dimensions

see SilverLine mechanics data sheet SL2.5/ SL5/ SL10

Unless otherwise stated, specifications are valid for AC 230V input voltage, +25°C ambient temperature, and 5 min. run-in time. They are subject to change without prior notice.

Your partner in power supply:



European Power Supply Manufacturers Association



Bayerns Best 50
Czech 100 Best
Europe's 500

PULS GmbH

Arabellastraße 15
D-81925 München
Tel.: +49 89 9278-0
Fax: +49 89 9278-199
www.puls-power.com

SL2.5/ SL5/ SL10

- Innovative DIN-Rail mount, unit holds even at vibration or lateral pressure
- Clearly arranged and user oriented
- Large, robust screw terminals
- Sealed metal housing
- Fine ventilating grid



Data sheet

Side view SL2.5

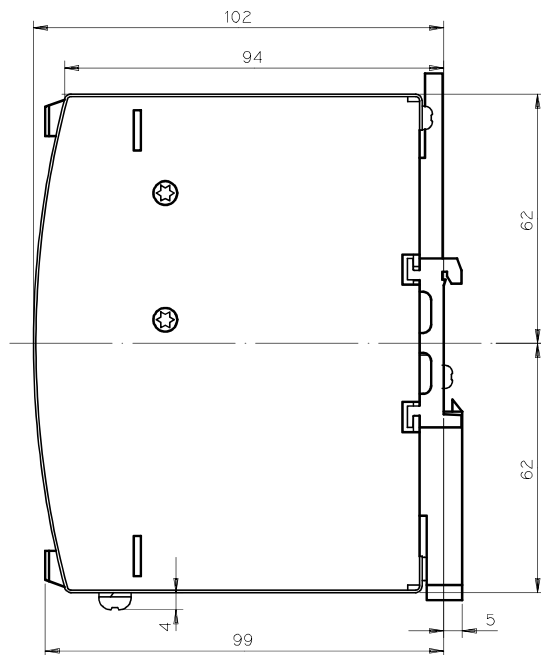

Front view SL2.5

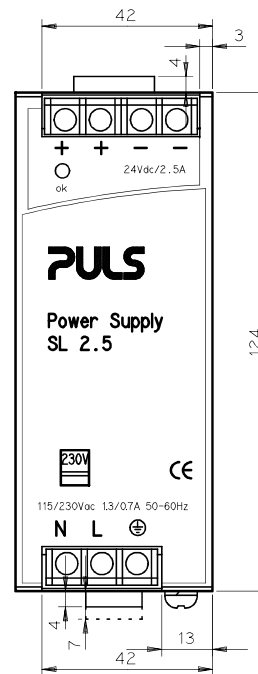

Bottom view SL2.5

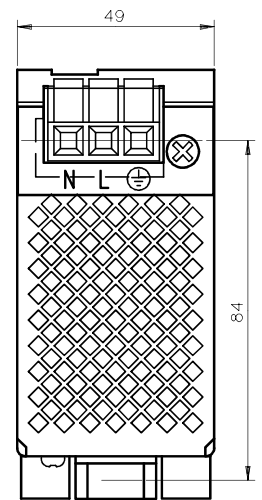

Construction / Mechanics

Unit	Housing dimensions and Weight		Free space for ventilation		
	W x H x D [mm]	weight	left	above/below	right
• SL2.5	49 x 124 x 102	460 g	0 mm	25 mm each	10 mm
• SL5.10x	64 x 124 x 102	620 g	15 mm	25 mm each	15 mm
• SL5.300	73 x 124 x 117	730 g	15 mm	50 mm each	15 mm
• SL10	120 x 124 x 102	980 g	15 mm	25 mm each	15 mm

Overall depth = depth value as mentioned + DIN rail depth

Robust metal housing with fine ventilat. grid (◇ 3,5 mm, IP20), to keep out small parts (e.g. screws)

Mounting on DIN-Rail (TS35/7.5 or TS35/15, 1...1.5 mm thick), thus

- Simple snap-on system
- Sits safely and firmly on the DIN-Rail
- No tools required to remove

or backplane-mounted (two optional screw mounting sets SLZ01 required)

Connections

- Connections
- Input/Output
 - Current handling capacity
 - Grid
- Screw terminals, connector size range: solid 0.5- 6 mm² / flexible 0.5- 4 mm²
30 A per output
Two connectors per output, 9 mm distance between adjacent connectors

Design advantages:

- All connection blocks are easy to reach as mounted at the the front panel.
- Input and output are strictly apart from each other and so cannot be mixed up

Order information

Order number	Description
SL2.100	24V/2.5A
SL2.103	12-15V/40W
SL5.100	24V/5A
SL5.102	24-28V/120W
SL5.105	24-28V/120W
SL5.300	24-28V/120W, 3AC400-500V input
SL10.100 and SL10.105	24-28V/240W
SL10.101	48-56V/240W
SLZ01	Screw mounting set, two needed per unit

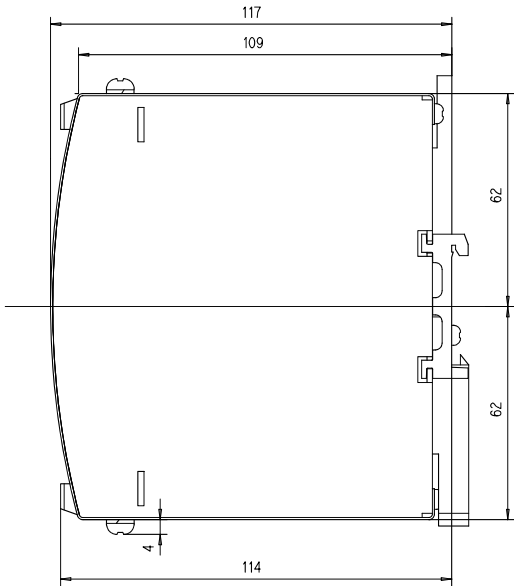

All views SL5.300

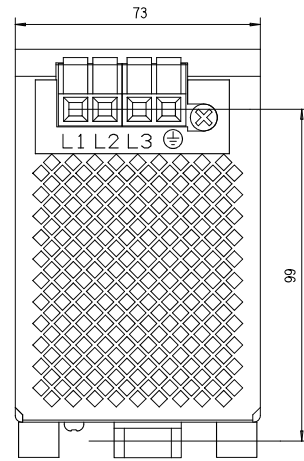
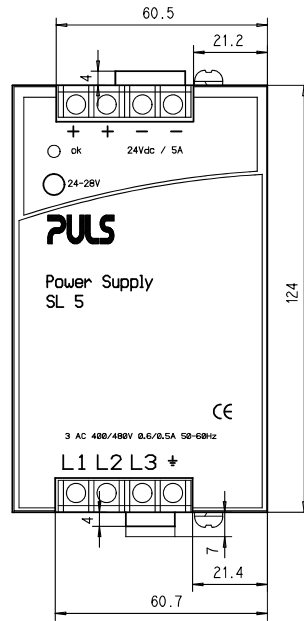

**Bottom view
SL10 SL5.10x**

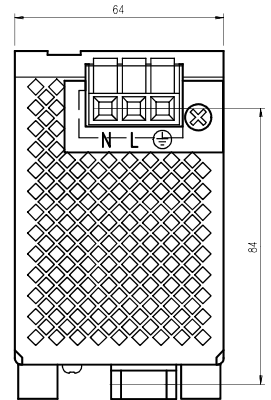
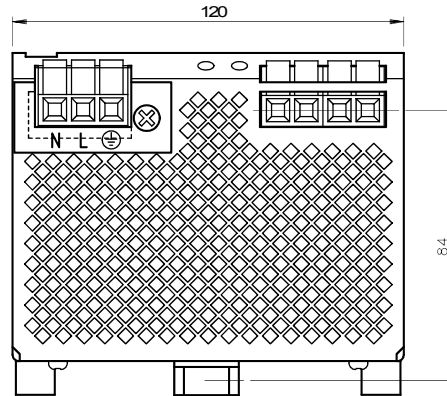

**Side view and front view
SL10, SL5.10x**

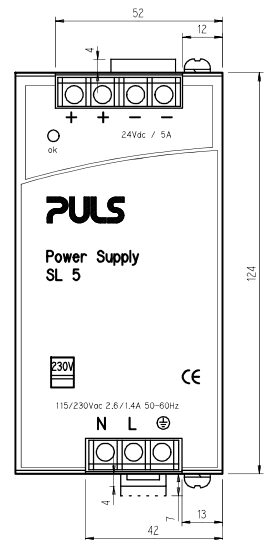
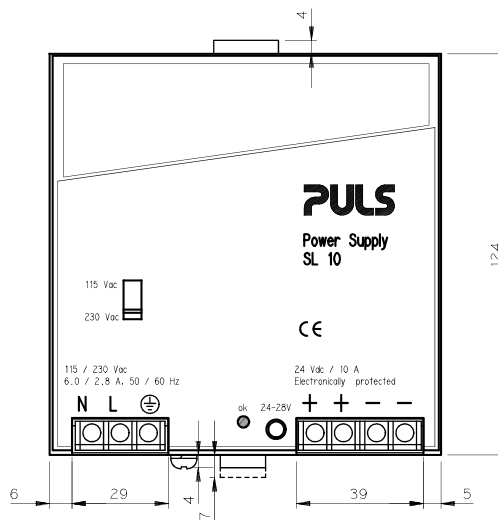
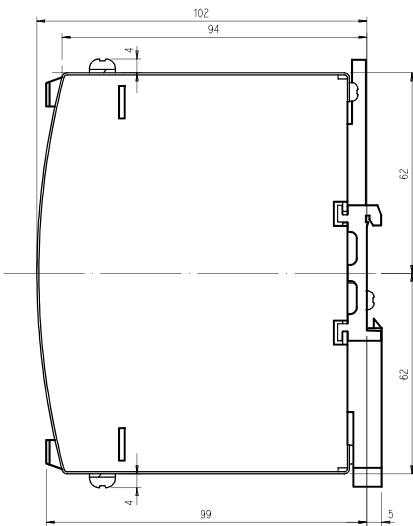

This 'mechanics data sheet' exclusively deals with the mechanical properties of the product. For further information (especially concerning electrical properties), please refer to the generic data sheet of the SL2.5, SL5 and SL10 and to the basic data sheet „The SilverLine“ dealing with common features of all SilverLine units. This data sheet is subject to change without prior notice.

Your partner in power supply:



Bayerns Best 50
Czech 100 Best
EuropeOs 500

PULS GmbH
Arabellastraße 15
D-81925 München
Tel.: +49 89 9278-0
Fax: +49 89 9278-199
www.puls-power.com