

DWG. NO. SD-35407-002
 SIMILAR ITEM
 PROJECT NO.
 F
 D
 C
 B
 DO NOT SCALE DRAWING DIMENSION IN METRIC

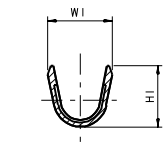

SECTION: C-C

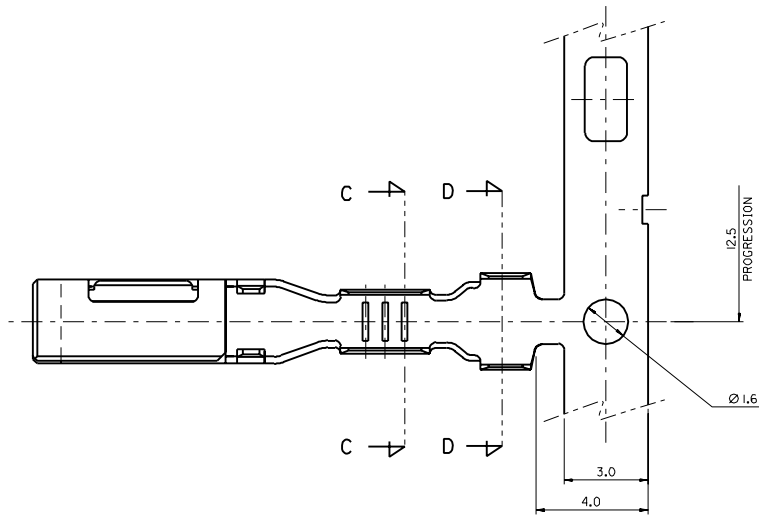
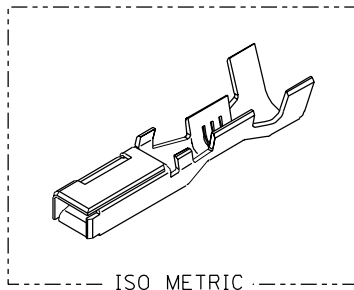
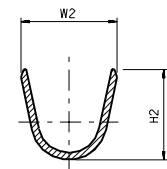
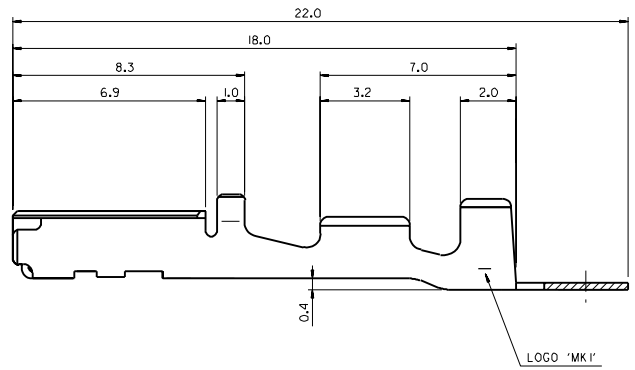

SECTION: D-D

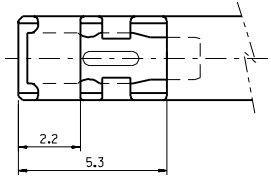
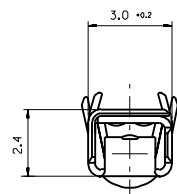

NOTE

1. MATERIAL: COPPER ALLOY, ±0.25.
2. FINISH: PRE-TIN PLATE.
3. RECOMMENDED LENGTH OF WIRE STRIP: 5.0-5.6.
4. INSERTION-EXTRACTION FORCE WITH TAB TERMINAL P/N 35420.
 INSERTION FORCE : 0.30±1.0 Kgf.
 AFTER SIX TIMES OF INSERTION & EXTRACTION FORCE : 0.15±1.0 Kgf.

NO.	ENG-NO.	TYPE	PART NAME	CABLE SIZE (mm ²)	DEMENSION			
					W1	H1	W2	H2
1	35407-6102	(S)	.090 FEMALE TER'L	AVSS(AVS) 0.3 - 0.5	2.5	2.4	3.4	3.5
2	35407-6202	(L)	.090 FEMALE TER'L	AVSS(AVS) 2.0	3.6	3.5	4.0	4.0
3	35407-6502	(M)	.090 FEMALE TER'L	AVSS(AVS) 0.85 - 1.25	2.6	3.0	4.0	4.0

CHANGED TENSION SPEC. EC NO. KPR2002-0090 DRWNS:MKJM 02/07/08 CHK'Y:SKJW 02/07/08 APPR:WLEE	QUALITY SYMBOLS MAJOR CRITICAL	GENERAL TOLERANCES: (UNLESS SPECIFIED) mm ± .10 INCH ± .005	SCALE 8:1	DESIGN UNITS <input checked="" type="checkbox"/> mm <input type="checkbox"/> INCH	DIMENSIONS: <input type="checkbox"/> mm <input type="checkbox"/> INCH <input type="checkbox"/> mm ONLY	SHT REV
		DRAWN BY & DATE B.C.YOON '98.4.10 CHECKED BY & DATE B.K.CHOI '98.4.10 APPROVED BY & DATE C.W.LEE '98.4.10	THIRD ANGLE PROJECTION <input checked="" type="checkbox"/> THIRD ANGLE <input type="checkbox"/> FIRST ANGLE	TITLE: .090 FEMALE TER'L (FT TYPE)	MOLEX INCORPORATED	SHEET NO. 1 OF 1
CAD FILENAME SD35407.DGN	MATERIAL NO. 354076102	DRAWING NO. SD-35407-002	THIS DRAWING CONTAINS INFORMATION THAT IS PROPRIETARY TO MOLEX INCORPORATED AND SHOULD NOT BE USED WITHOUT WRITTEN PERMISSION.	SIZE C	MX-A2	