

High precision fluxgate AC/DC current transducer for galvanically isolated measurement up to 150 A

Features

- 100 A rms nominal current
- 1000 primary/secondary current ratio
- Current output
- Ø20.7 mm aperture
- 51 ppm total accuracy
- 1 ppm linearity
- 50 ppm offset
- 2 MHz bandwidth
- Status signal and LED

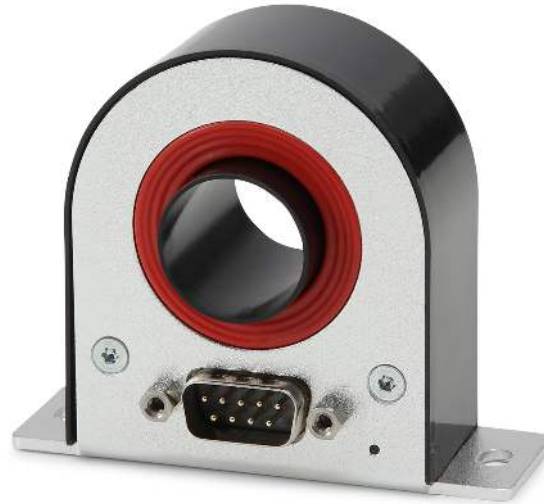

Description

High precision DC current transducer (DCCT) measuring up to 150 A currents and continuously measuring 100 A currents with a linearity error less than 1 ppm. With a compact size and lightweight design, the DT100ID allows precision current sensing in tight spaces.

Based on the ultra stable Danisense closed loop flux gate technology, the DT100ID has very low offset and ultra low drift. The 2 MHz bandwidth allows high frequency and high precision measurements combined in a convenient package.

It provides high resolution for precise monitoring, reliable and consistent performance, and a compact and rugged design for easy installation and durability.

Applications

- Space constrained applications
- Power measurement and power analysis
- Particles accelerators
- MRI devices and medical scanners
- Battery testing and evaluation systems
- Current calibration purposes
- Precision current sensing

Electrical specifications at 23 °C, $V_S = \pm 15$ V supply voltage

Parameter	Symbol	Unit	Min	Typ.	Max	Comment
Nominal primary AC current	$I_{PN\ AC}$	Arms			100	Refer to Fig. 3 for derating
Nominal primary DC current	$I_{PN\ DC}$	A	-100		100	Refer to Fig. 3 for derating
Measuring range	I_{PM}	A	-150		150	Refer to Fig. 3 for derating
Overload capacity	I_{OL}	A	-500		500	Non-measured 100ms
Nominal secondary current	I_{SN}	mA	-100		100	At nominal primary DC current
Primary / secondary ratio	k	A/A	1000		1000	$I_{primary}/I_{secondary}$
Measuring resistance	R_M	Ω	0	50		Refer to Fig. 2 for details
Linearity error	ϵ_L	ppm	-1	0.4	1	ppm refers to nominal current
Offset current (including earth field)		ppm	-50		50	ppm refers to nominal current
Offset temperature coefficient		ppm/K	-0.3	0.15	0.3	ppm refers to nominal current
Offset stability over time		ppm/month	-0.1		0.1	ppm refers to nominal current
Bandwidth	$f(\pm 3dB)$	MHz		2		Small signal. See Fig. 4
Response time to a step current I_{PN}	t_r	μs		1		To 90% of step current
Total accuracy	ϵ_{tot}		% of reading + % of full scale			Without offset.
<10 Hz			0.0001 + 0.00001			Full scale refers to $I_{PN\ DC}$.
<100 Hz			0.0002 + 0.0001			For details, see Reading and full scale .
<1 kHz			0.01 + 0.0002			See Fig. 4 for more.
<10 kHz			0.015 + 0.0002			
<100 kHz			3 + 0.002			
<1MHz			15 + 0.01			
<2MHz			30 + 0.01			
Phase shift				0.01°		
<10 Hz				0.01°		
<100 Hz				0.01°		
<1 kHz				0.03°		
<10 kHz				0.2°		
<100 kHz				3°		
<1MHz				20°		
<2MHz				30°		
RMS noise		ppm rms		0.03	0.07	ppm refers to nominal current
<10 Hz				0.03	0.07	
<100 Hz				0.5	1.1	
<1 kHz				0.6	1.5	
<10 kHz				0.9	2	
<100 kHz				6.5	12	
Peak-to-peak noise		ppm p-p		0.4	0.5	ppm refers to nominal current
<10 Hz				0.4	0.5	
<100 Hz				1.6	2	
<1 kHz				3.2	4	
<10 kHz				5.1	8	
<100 kHz				50	80	
Fluxgate excitation frequency	f_{exc}	kHz		15.6		
Power supply voltages		V_{ac}	± 14.25		± 15.75	
Idle current consumption		mA		± 40		Primary current = 0 A
Current consumption at max current		mA	-190		190	At I_{PM}
Power consumption		W			3.7	At I_{PM}
Operating temperature range	T_a	°C	-40		85	
Offset change with external magnetic field		ppm/mT	-8	2	8	ppm refers to nominal current
Offset change with power supply voltage changes		ppm/V		2.6		ppm refers to nominal current

1 ppm nominal = 0.1 μA secondary current.

Linearity error

Linearity error is defined as the deviation from a straight line. The straight line is a linear regression trend line based on the least squares method of the measurement points from 0 to positive max current and another trendline is calculated from 0 to negative max current. The difference between each measured point and the linear trend line is the linearity error. The linearity error ϵ_L can be expressed as (1), where I_{reading} is the measurement result and I_{fitted} is the regression value.

$$\epsilon_L = I_{\text{reading}} - I_{\text{fitted}} \tag{1}$$

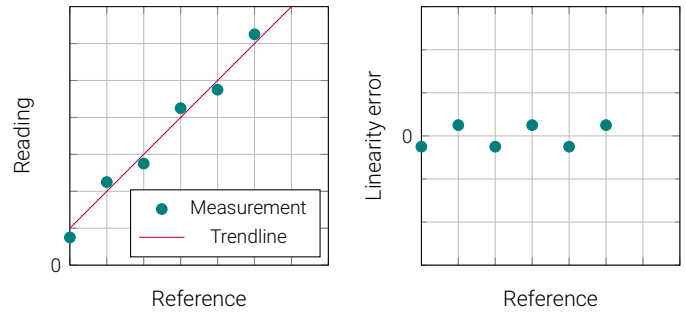

Figure 1: Linearity error definition

Reading and full scale

Reading is the actual value measured at a given time. Full scale is the rated nominal value of the device. If a given current I_{reading} is measured, the total accuracy is calculated as (2). Example: A 500 A rated device has a specification of 0.005% + 0.0015% (reading + full scale) at < 10 Hz. The device is measuring (reading) 10 A dc, and the accuracy is calculated as (3).

$$\epsilon_{\text{tot}} = \epsilon_{\text{reading}} \cdot I_{\text{reading}} + \epsilon_{\text{fullscale}} \cdot I_{\text{PNDC}} \tag{2}$$

$$\epsilon_{\text{tot}} = 0.005\% \cdot 10\text{A} + 0.0015\% \cdot 500\text{A} = 8\text{mA} \tag{3}$$

Primary and secondary current/voltage

The secondary current I_S or voltage V_S is calculated by using the transfer ratio k , as in (4).

$$I_S = \frac{I_P}{k}, \quad V_S = \frac{V_P}{k} \tag{4}$$

Converting from ppm of nominal to secondary current/voltage

The nominal primary current is the rated current for the device. If ϵ_{ppm} is the error in ppm referred to nominal, use (5) to convert to ampere primary current. If the primary/secondary transfer ratio is k , use (6) to convert to ampere secondary current. If the device has voltage output, use (7)

$$\epsilon_{\text{Pampere}} = \epsilon_{\text{ppm}} \cdot I_{\text{PNDC}} \cdot 1 \times 10^{-6} \tag{5}$$

$$\epsilon_{\text{Sampere}} = \epsilon_{\text{ppm}} \cdot \frac{I_{\text{PNDC}}}{k} \cdot 1 \times 10^{-6} \tag{6}$$

$$\epsilon_{\text{Svoltage}} = \epsilon_{\text{ppm}} \cdot \frac{V_{\text{PNDC}}}{k} \cdot 1 \times 10^{-6} \tag{7}$$

Linear interpolation of accuracy specification

If the accuracy at a specific frequency is required, it is possible to use linear interpolation between known points. If the frequency f is $f_1 < f < f_2$ and the accuracy at the frequency $\epsilon(f)$ is $\epsilon(f_1) < \epsilon(f) < \epsilon(f_2)$, then the accuracy at f is found as (8).

$$\epsilon(f) = \frac{f_2 - f_1}{\epsilon(f_2) - \epsilon(f_1)} (f - f_1) + \epsilon(f_1) \tag{8}$$

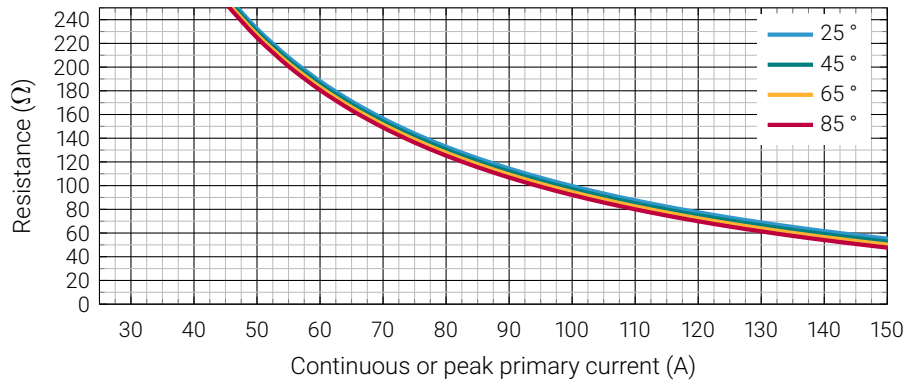

Figure 2: Maximum measurement resistor R_M vs. current and ambient temperature

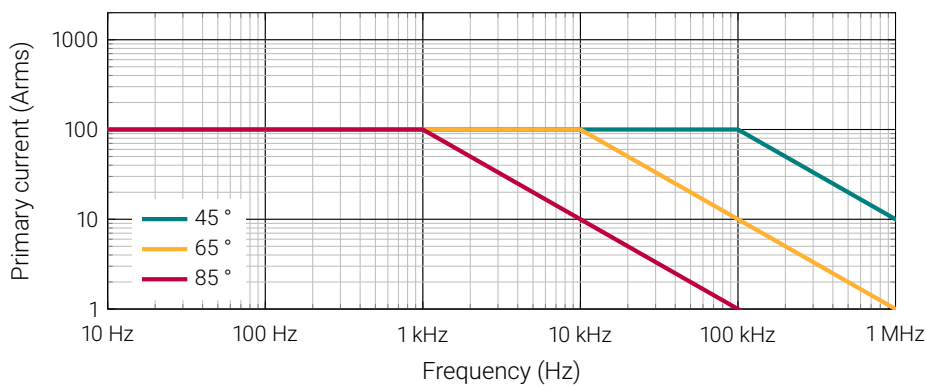

Figure 3: Maximum continuous primary current vs. frequency

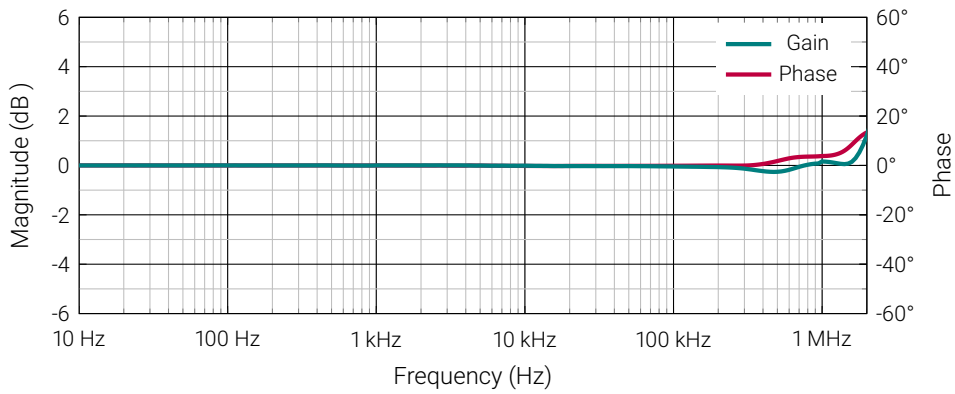

Figure 4: Frequency characteristics. For high frequency measurement, see <https://danisense.com/wp-content/uploads/Current-Measurements-at-High-Frequencies.pdf>

Isolation specifications according to IEC 61010-1



When using *REINFORCED insulated* wire, all wiring must be insulated for the highest voltage used. When using *BASIC insulated* or *uninsulated* wire, follow the specified voltages in the table below:

Parameter	Unit	Value
Clearance	mm	8.5
Creepage distance	mm	11.5
Comparative tracking index (CTI)	V	> 600
Continuous working voltage according to IEC 61010-1 with:		
<i>Uninsulated</i> wire:		
Non mains		1000
CAT II (dc and rms)		600
CAT III (dc and rms)		300
<i>BASIC insulated</i> wire:	V	
Non mains		2000
CAT II (dc and rms)		1000
CAT III (dc and rms)		1000
Transient voltage according to IEC 61010-1 with:		
<i>Uninsulated</i> wire:		
Non mains		4000
CAT II		6000
CAT III		6000
<i>BASIC insulated</i> wire:	V	
Non mains		3500
CAT II		6000
CAT III		8000



Do not connect the transducer to signals or use for measurements within Measurement Category IV, or for measurements on MAINS circuits or on circuits derived from Overvoltage Category IV which may have transient overvoltages above what the product can withstand. The product must not be connected to circuits that have a maximum voltage above the continuous working voltage, relative to earth or to other channels, or this could damage and defeat the insulation.

Environmental and mechanical characteristics

Parameter	Unit	Min	Typ	Max	Comment
Altitude	m			2000	
Usage					Designed for indoor use
Pollution degree				2	
Operating temperature range	°C	-40		85	
Storage temperature range	°C	-40		85	
Relative humidity	%	20		80	Non-condensing
Ingress protection rating				IP20	
Mass	kg		0.15		

Connections: DSUB-9
 EMC: EN 61326-1:2013-2021
 Safety: IEC 61010-2-030:2021/A11:2021 and IEC 61010-1:2010/A1:2019
 Random vibration test: IEC 60068-2-64:2008

Shock test:	IEC 60068-2-27:2009
External devices:	External devices connected to current transducers must comply with the standards IEC61010-1 and IEC62368-1 and be energy-limited circuitry
Cleaning:	The transducer should only be cleaned with a damp cloth. No detergent or chemicals should be used.
Temperature:	When multiple primary turns are used or high primary currents are applied the temperature around the transducer will increase, please monitor to ensure that the maximum ratings are not exceeded. It is recommended to have minimum 1 mm ² per ampere in the primary bus bar.

Intended use

The DT100ID is designed to measure current up to 150 A, and be powered by a DSSIU-4-1U or DSSIU-6-1U or similar power supplies. Please see the product manual: <https://danisense.com/wp-content/uploads/2021/11/DS-Product-Manual-v1-2.pdf>

Instruction for use

 Please follow the polarity of the voltage supply to avoid damaging the device. See Fig. 6.

1. Do not power up the device before all cables are connected.
2. Place the primary conductor through the aperture of the transducer.
3. Connect a DSUB cable between DSSIU-4/6-1U and each sensor.
4. Connect a low impedance amperemeter, measuring resistor or power analyzer on the secondary output (4mm red and black connectors on the DSSIU-4/6-1U).
5. Ensure that no calibration connectors are attached when measuring primary current. Always avoid to create a calibration short circuit, between + and – calibration connection.
6. When all connection are secured - connect mains power.
7. Apply primary current.

 There is a risk of electrical shock if an uninsulated busbar with high voltages is touching the metal enclosure of the transducer. Please ensure, before powering up the system, that no uninsulated wire can touch the metal enclosure.

 Do not disassemble the unit. If the green status LED is not operating with all cables connected and the system powered up, disconnect power and contact Danisense for further instruction. If the equipment is used in a manner not specified by the manufacturer, the protection provided by the equipment may be impaired.

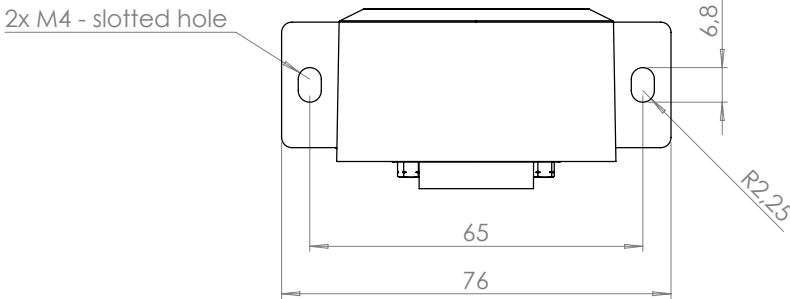
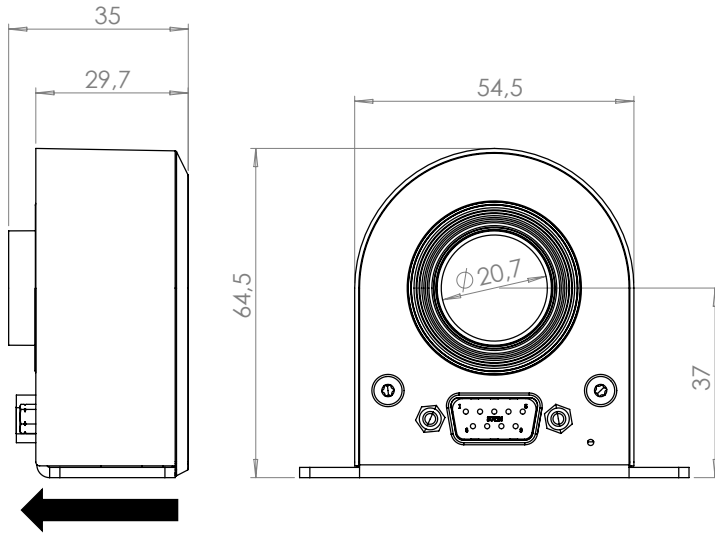

Figure 5: Dimensions of transducer. 0.3 mm Tolerance

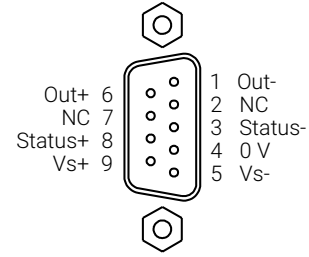

Figure 6: DSUB-9 connection pinout

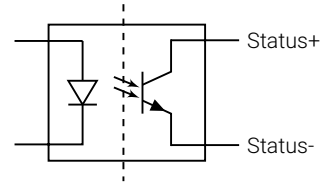

Figure 7: Status signal optocoupler

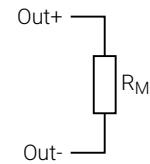

Figure 8: External measurement resistor connection, see Fig. 2

Mounting

- Base plate mounting: 2 slotted holes $\varnothing 6$ mm
- Back plate mounting: 4 slotted holes $\varnothing 6$ mm
- Fastening torque: 5.5 Nm

Pin out description

- | | | |
|---|-----------------|--------------------------------------|
| 1 | Out- | Measurement output negative terminal |
| 2 | NC | No connection |
| 3 | Status- | Status signal negative terminal |
| 4 | 0 V | 0 V connection for supply voltage |
| 5 | V _{s-} | Negative supply voltage |
| 6 | Out+ | Measurement output positive terminal |
| 7 | NC | No connection |
| 8 | Status+ | Status signal positive terminal |
| 9 | V _{s+} | Positive supply voltage |

Positive current direction

Is identified by an arrow on the back side isolation plastic insert.

Status signal and LED

When the sensor is operating in normal condition the status pins (Status+ and Status-) are shorted by an optocoupler and the green status LED is ON, see Fig. 7. When a fault is detected, or the power is off, the status pins are opened and the green status LED is OFF. Status signal optocoupler ratings found below:

- Forward direction: Status+ to Status- (Pin 8 to pin 3)
- Maximum forward current: 10 mA
- Maximum forward voltage: 60 V
- Maximum reverse voltage: 5 V

Declaration of Conformity

Danisense A/S
Malervej 10
DK-2630 Taastrup
Denmark

Declares that under our sole responsibility that this product is in conformity with the provisions of the following EC Directives, including all amendments, and with national legislation implementing these directives:

Directive 2014/30/EU

Directive 2014/35/EU

And that the following harmonized standards have been applied

EEN 61010-1 (Third Edition):2010, EN 61010-1:2010/A1:2019

EN 61010-2-030:2021/A11:2021

EN 61326-1:2013

All DANISENSE products are manufactured in accordance with RoHS directive 2011/65/EU. Annex II of the RoHS directive was amended by directive 2015/863 in force since 2015, expanding the list of 6 restricted substances (Lead, Hexavalent Chromium, PBB, PBDE and Cadmium)

Danisense follows the provision in EN 63000:2018



Place

Taastrup, Denmark

Date

2022-03-15

Henrik Elbæk