

SMT power inductors

PID differential mode inductors

Series/Type: PID*-560M/650M

Date: September 2022

Rated inductance 2 x 56 μ H or 2 x 65 μ H

Construction

- Ferrite core
- Magnetically shielded
- Winding enamel copper wire
- Winding welded to terminals



Features

- Temperature range up to +150 °C
- High rated current
- Low DC resistance
- Functional isolation up to 500 V
- Suitable for lead-free reflow soldering as referenced in JEDEC J-STD 020E
- RoHS-compatible

Applications

- Industrial electronics
- Power over Data Line (PoDL) for 10BASE-T1L (IEEE 802.3 cg)
- Differential mode choke

Terminals

- Base material CuSn6P
- Lead-finish Sn (lead-free)
- Electro-plated

Marking

- Marking on component:
 PID75 and PID100: Date of manufacture (YWWD), Code letter "D", L value (in μ H), dot for Pin 1 identification
 PID120L and PID120HS: Product series, code letter "D", L value (in μ H), date of manufacture (YWWD), two last digits of production order, dot for Pin 1 identification

Delivery mode and packing units

- Blister tape, wound on 330-mm \varnothing reel
 - 16-mm blister tape for PID75
 - 24-mm blister tape for PID100, PID120L, PID120HS
- Packing unit:
 - 1000 pcs./reel for PID75
 - 600 pcs./reel for PID100
 - 350 pcs./reel for PID120L
 - 250 pcs./reel for PID120HS

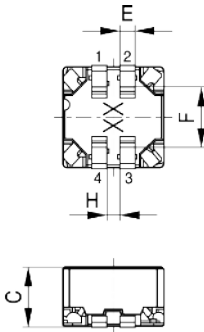
Dimensional drawing

Ordering code	A	B	C
PID75	7.5 max.	7.5 max.	4.8 max.
PID100	10.4 max.	10.4 max.	6.3 max.
PID120L	12.5 max.	12.5 max.	8.5 max.
PID120HS	12.5 max.	12.5 max.	10.5 max.

Ordering code	E	F	H
PID75	0.8 ±0.1	3.8 ±0.2	1.0 ±0.1
PID100	1.5 ±0.2	6.0 ±0.2	1.3 ±0.2
PID120L	1.8 ±0.2	7.2 ±0.2	1.5 ±0.2
PID120HS	1.8 ±0.2	7.2 ±0.2	1.5 ±0.2

Dimensions in mm

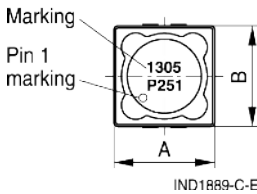
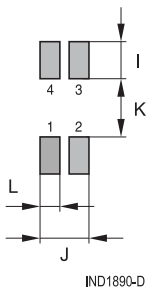
Layout recommendation

Ordering code	I	J	K	L
PID75	2.1	2.8	3.3	1.1
PID100	2.4	4.5	5.7	1.7
PID120L	3.1	5.8	6.8	2.3
PID120HS	3.1	5.8	6.8	2.3

Dimensions in mm

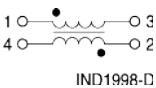
Circuit diagram

Taping and packing

PID75

Blister tape

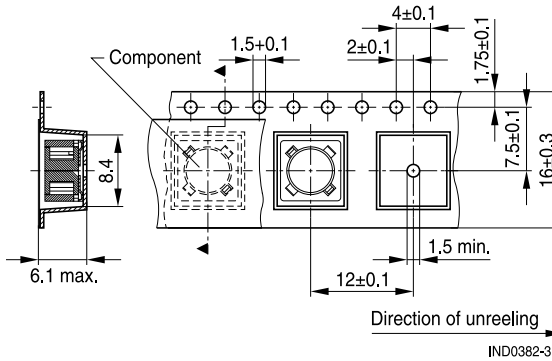

Reel

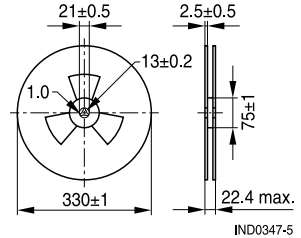

PID100

Blister tape

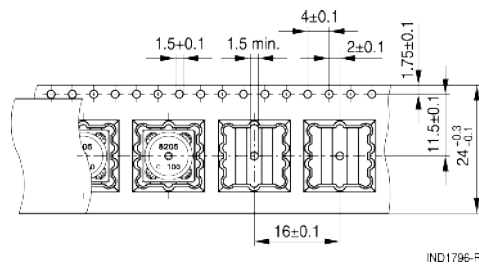

Reel

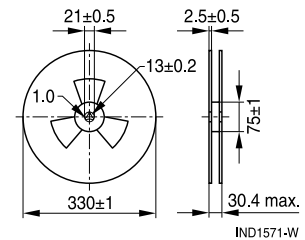

PID120L

Blister tape

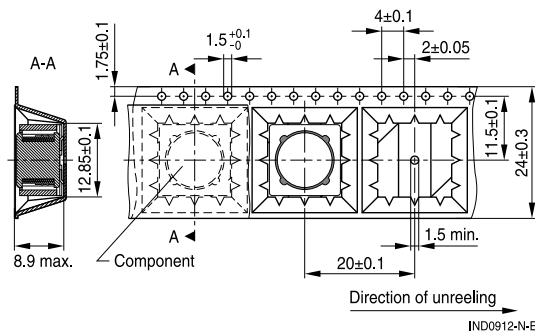

Reel

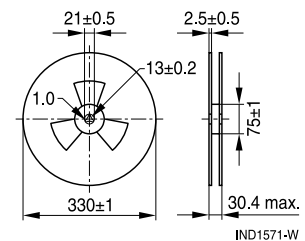

Technical data and measuring conditions

Rated inductance L_1, L_2	Measured with LCR meter Agilent 4284A (or equivalent) at frequency f_L , 0.1 V, +23 °C, per winding
Tolerance	±20%
Coupling factor K_{typ}	Coupling in between the 2 windings. $K = \sqrt{1 - \frac{L_s}{L_n}}$
Inductance L_{PoDL}	Typ. 225 µH (for PID*-560M) and typ. 250 µH (for PID*-650M), equivalent inductance when both windings are connected in series (measured in 1-4 with 2-3 shorted)
Operating temperature range	-40 °C to +150 °C (self-rise temperature included)
Rated current I_R	Max. typ. permissible DC with temperature increase of ≤40 K Method as per IEC62024-2, when both windings are connected in series (measured in 1-4 with 2-3 shorted)
Saturation current I_{Sat}	DC with inductance decrease $\Delta L/L_0$ of approx. 30%, when both windings are connected in series (measured in 1-4 with 2-3 shorted), typical values
DC resistance R_1, R_2 , (max.)	Measured at +23 °C, is specified per winding
Isolation (functional)	Tested with 500 V, 0.4 s by 100%; 3 s during qualification
Solderability (lead-free)	Dip and look method, Wetting of soldering area ≥95% as referenced in EIA/IPC/JEDEC J-STD-002E
Resistance to soldering heat	as referenced in JEDEC J-STD-020E
Climatic category	40/150/56 (to IEC 60068-1)
Storage conditions	Mounted: -40 °C ... +150 °C Packaged: -25 °C ... +40 °C, ≤75% RH
Weight	Approx. 0.9 g for PID75 Approx. 2.5 g for PID100 Approx. 4.2 g for PID120L Approx. 5.0 g for PID120HS

Characteristics and ordering codes for PID*-560M

Size	IEEE 802.3cg Power class	K_{typ}	$R_{DC,typ}$	$I_{Sat,typ}$	$I_{R,typ}$ (ambient temp.)	Internal code	Ordering code
mm		%	Ω	mA	mA		
7.5 x 7.5 x 4.5	10, 11, 13	99	0.48	800	580 (+25 °C) 530 (+85 °C) 500 (+105 °C)	B82472E6563M000	PID75-560M
10.4 x 10.4 x 6	12, 14	99	0.28	1350	950 (+25 °C) 790 (+85 °C) 770 (+105 °C)	B82464E6563M000	PID100-560M
12.5 x 12.5 x 8	12, 14	99	0.17	1950	1350 (+25 °C) 1200 (+85 °C) 1150 (+105 °C)	B82477E4563M000	PID120L-560M
12.5 x 12.5 x 10.5	15	86	0.09	2200	1900 (+25 °C) 1740 (+85 °C) 1680 (+105 °C)	B82477F6563M000	PID120HS-560M

Characteristics and ordering codes for PID*-650M

Size	IEEE 802.3cg Power class	K_{typ}	$R_{DC,typ}$	$I_{Sat,typ}$	$I_{R,typ}$ (ambient temp.)	Internal code	Ordering code
mm		%	Ω	mA	mA		
7.5 x 7.5 x 4.5	10, 11, 13	99	0.53	750	560 (+25 °C) 505 (+85 °C) 490 (+105 °C)	B82472E6653M000	PID75-650M
10.4 x 10.4 x 6	12, 14	99	0.30	1200	880 (+25 °C) 780 (+85 °C) 750 (+105 °C)	B82464E6653M000	PID100-650M
12.5 x 12.5 x 8	12, 14	99	0.19	1800	1280 (+25 °C) 1160 (+85 °C) 1120 (+105 °C)	B82477E4653M000	PID120L-650M
12.5 x 12.5 x 10.5	15	86	0.12	2100	1640 (+25 °C) 1450 (+85 °C) 1390 (+105 °C)	B82477F6653M000	PID120HS-650M

Inductance versus I_{DC} (typical values, series L)

PID75-560M

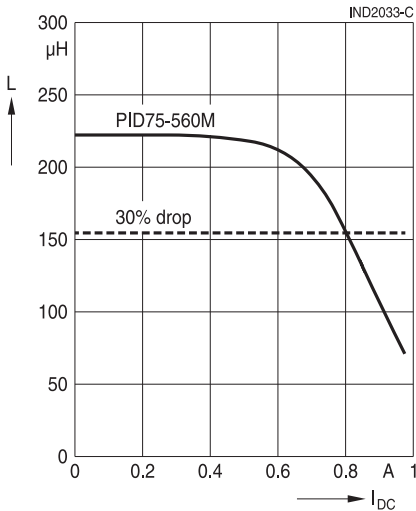

PID100-560M

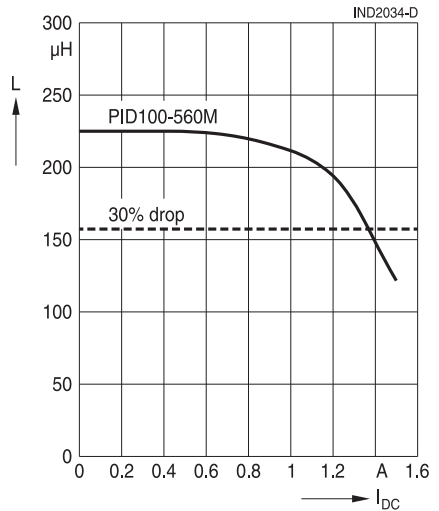

PID120L-560M

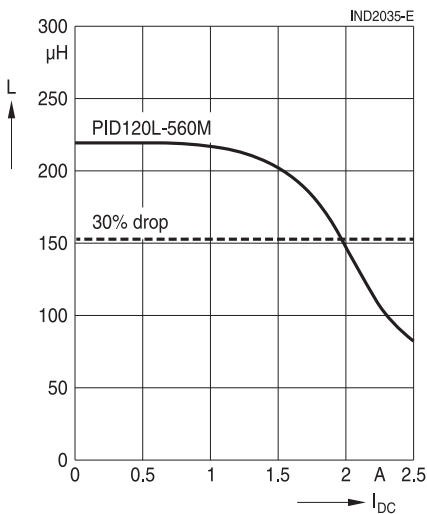

PID120HS-560M

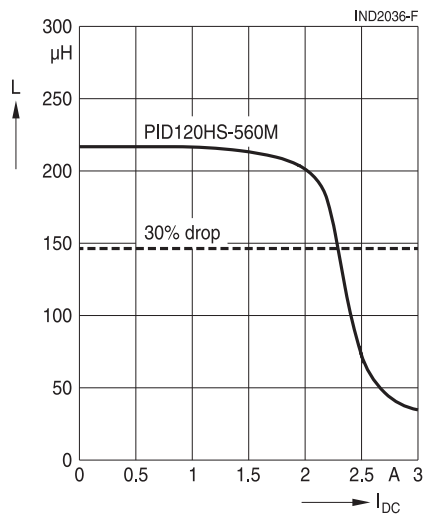

Inductance versus I_{DC} (typical values, series L)

PID75-650M

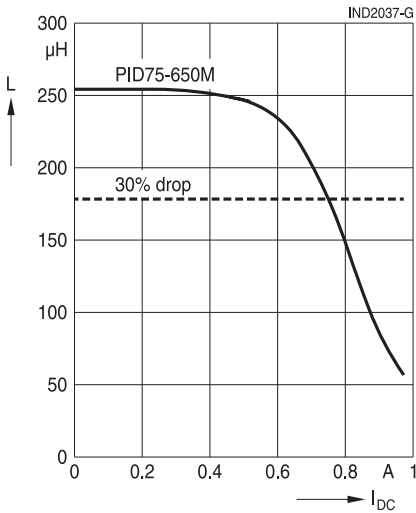

PID100-650M

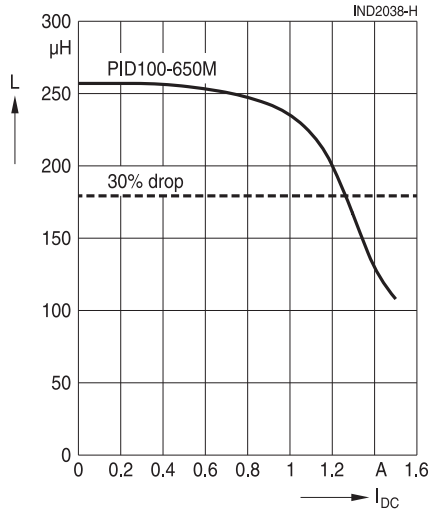

PID120L-650M

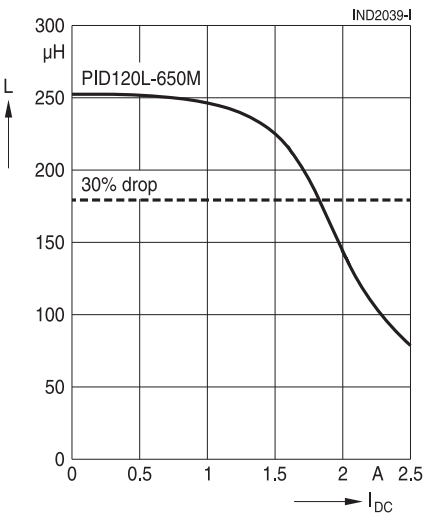

PID120HS-650M

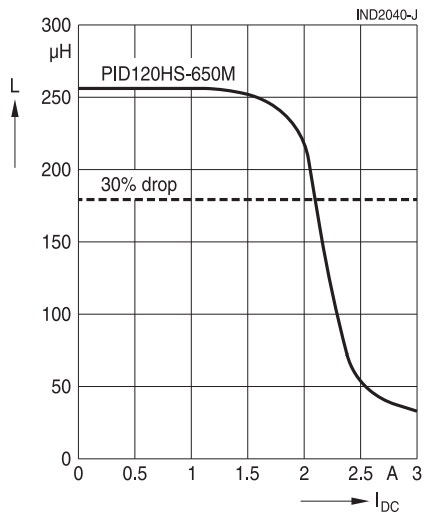

Cautions and warnings

- Please note the recommendations in our Inductors data book (latest edition) and in the data sheets.
 - Particular attention should be paid to the derating curves given there.
 - The soldering conditions should also be observed. Temperatures quoted in relation to wave soldering refer to the pin, not the housing.
- If the components are to be washed varnished it is necessary to check whether the washing varnish agent that is used has a negative effect on the wire insulation, any plastics that are used, or on glued joints. In particular, it is possible for washing varnish agent residues to have a negative effect in the long-term on wire insulation. Washing processes may damage the product due to the possible static or cyclic mechanical loads (e.g. ultrasonic cleaning). They may cause cracks to develop on the product and its parts, which might lead to reduced reliability or lifetime.
- The following points must be observed if the components are potted in customer applications:
 - Many potting materials shrink as they harden. They therefore exert a pressure on the plastic housing or core. This pressure can have a deleterious effect on electrical properties, and in extreme cases can damage the core or plastic housing mechanically.
 - It is necessary to check whether the potting material used attacks or destroys the wire, wire insulation, plastics or glue.
 - The effect of the potting material can change the high-frequency behaviour of the components.
 - Many coating materials have a negative effect (chemically and mechanically) on the winding wires, insulation materials and connecting points. Customers are always obligated to determine whether and to what extent their coating materials influence the component. Customers are responsible and bear all risk for the use of the coating material. TDK Electronics does not assume any liability for failures of our components that are caused by the coating material.
- Ceramics / ferrites are sensitive to direct impact. This can cause the core material to flake, or lead to breakage of the core.
- Even for customer-specific products, conclusive validation of the component in the circuit can only be carried out by the customer.
- Due to product design and applied manufacturing process, appearance, symmetry, and shape of not dimensioned details could vary within same lot, as well discoloration of housing is possible. TDK does not expect detrimental effects on product function or reliability. In case of conflicts, TDK reference standard shall prevail.

Display of ordering codes for TDK Electronics products

The ordering code for one and the same product can be represented differently in data sheets, data books, other publications, on the company website, or in order-related documents such as shipping notes, order confirmations and product labels. **The varying representations of the ordering codes are due to different processes employed and do not affect the specifications of the respective products.** Detailed information can be found on the Internet under www.tdk-electronics.tdk.com/orderingcodes.

Important notes

The following applies to all products named in this publication:

1. Some parts of this publication contain **statements about the suitability of our products for certain areas of application**. These statements are based on our knowledge of typical requirements that are often placed on our products in the areas of application concerned. We nevertheless expressly point out **that such statements cannot be regarded as binding statements about the suitability of our products for a particular customer application**. As a rule, we are either unfamiliar with individual customer applications or less familiar with them than the customers themselves. For these reasons, it is always ultimately incumbent on the customer to check and decide whether a product with the properties described in the product specification is suitable for use in a particular customer application.
2. We also point out that **in individual cases, a malfunction of electronic components or failure before the end of their usual service life cannot be completely ruled out in the current state of the art, even if they are operated as specified**. In customer applications requiring a very high level of operational safety and especially in customer applications in which the malfunction or failure of an electronic component could endanger human life or health (e.g. in accident prevention or life-saving systems), it must therefore be ensured by means of suitable design of the customer application or other action taken by the customer (e.g. installation of protective circuitry or redundancy) that no injury or damage is sustained by third parties in the event of malfunction or failure of an electronic component.
3. **The warnings, cautions and product-specific notes must be observed.**
4. In order to satisfy certain technical requirements, **some of the products described in this publication may contain substances subject to restrictions in certain jurisdictions (e.g. because they are classed as hazardous)**. Useful information on this will be found in our Material Data Sheets on the Internet (www.tdk-electronics.tdk.com/material). Should you have any more detailed questions, please contact our sales offices.
5. We constantly strive to improve our products. Consequently, **the products described in this publication may change from time to time**. The same is true of the corresponding product specifications. Please check therefore to what extent product descriptions and specifications contained in this publication are still applicable before or when you place an order.
We also **reserve the right to discontinue production and delivery of products**. Consequently, we cannot guarantee that all products named in this publication will always be available. The aforementioned does not apply in the case of individual agreements deviating from the foregoing for customer-specific products.
6. Unless otherwise agreed in individual contracts, **all orders are subject to our General Terms and Conditions of Supply**.

Important notes

7. **Our manufacturing sites serving the automotive business apply the IATF 16949 standard.**
The IATF certifications confirm our compliance with requirements regarding the quality management system in the automotive industry. Referring to customer requirements and customer specific requirements (“CSR”) TDK always has and will continue to have the policy of respecting individual agreements. Even if IATF 16949 may appear to support the acceptance of unilateral requirements, we hereby like to emphasize that **only requirements mutually agreed upon can and will be implemented in our Quality Management System.** For clarification purposes we like to point out that obligations from IATF 16949 shall only become legally binding if individually agreed upon.
8. The trade names EPCOS, CarXield, CeraCharge, CeraDiode, CeraLink, CeraPad, CeraPlas, CSMP, CTVS, DeltaCap, DigiSiMic, ExoCore, FilterCap, FormFit, InsuGate, LeaXield, MiniBlue, MiniCell, MKD, MKK, ModCap, MotorCap, PCC, PhaseCap, PhaseCube, PhaseMod, PhiCap, PowerHap, PQSine, PQvar, SIFERRIT, SIFI, SIKOREL, SilverCap, SIMDAD, SiMic, SIMID, SineFormer, SIOV, ThermoFuse, WindCap, XieldCap are **trademarks registered or pending** in Europe and in other countries. Further information will be found on the Internet at www.tdk-electronics.tdk.com/trademarks.

Release 2022-07