



PTVSxS1UTR series

High-temperature 400 W Transient Voltage Suppressor

Rev. 1 — 11 October 2011

Product data sheet

1. Product profile

1.1 General description

400 W unidirectional Transient Voltage Suppressor (TVS) in a SOD123W small and flat lead low-profile Surface-Mounted Device (SMD) plastic package, designed for transient overvoltage protection in high-temperature applications.

1.2 Features and benefits

- Rated peak pulse power:
 $P_{PPM} = 400 \text{ W}$ (350 W for 3V3)
- Reverse standoff voltage range:
 $V_{RWM} = 3.3 \text{ V}$ to 64 V
- Reverse current: $I_{RM} = 0.001 \mu\text{A}$
- Very low package height: 1 mm
- High temperature stability $T_j \leq 185 \text{ }^\circ\text{C}$
- Small plastic package suitable for surface-mounted design
- AEC-Q101 qualified

1.3 Applications

- Power supply protection
- Automotive application
- Industrial application
- Power management
- High-temperature applications

1.4 Quick reference data

Table 1. Quick reference data



Symbol	Parameter	Conditions	Min	Typ	Max	Unit
P_{PPM}	rated peak pulse power		[1][2]	-	400	W
V_{RWM}	reverse standoff voltage		3.3	-	64	V

[1] In accordance with IEC 61643-321 (10/1000 μs current waveform).

[2] For PTVS3V3S1UTR: $P_{PPM} = 350 \text{ W}$

2. Pinning information

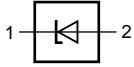
Table 2. Pinning

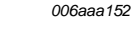
Pin	Description	Simplified outline	Graphic symbol
1	cathode	[1]	
2	anode		 006aaa152

[1] The marking bar indicates the cathode.

3. Ordering information

Table 3. Ordering information

Type number [1]	Package		
	Name	Description	Version
PTVSxS1UTR series	-	plastic surface-mounted package; 2 leads	SOD123W

[1] The series consists of 35 types with reverse standoff voltages from 3.3 V to 64 V.

4. Marking

Table 4. Marking codes

Type number	Marking code	Type number	Marking code
PTVS3V3S1UTR	C2	PTVS20VS1UTR	CL
PTVS5V0S1UTR	C3	PTVS22VS1UTR	CM
PTVS6V0S1UTR	C4	PTVS24VS1UTR	CN
PTVS6V5S1UTR	C5	PTVS26VS1UTR	CP
PTVS7V0S1UTR	C6	PTVS28VS1UTR	CR
PTVS7V5S1UTR	C7	PTVS30VS1UTR	CS
PTVS8V0S1UTR	C8	PTVS33VS1UTR	CT
PTVS8V5S1UTR	C9	PTVS36VS1UTR	CU
PTVS9V0S1UTR	CA	PTVS40VS1UTR	CV
PTVS10VS1UTR	CB	PTVS43VS1UTR	CW
PTVS11VS1UTR	CC	PTVS45VS1UTR	CX
PTVS12VS1UTR	CD	PTVS48VS1UTR	CY
PTVS13VS1UTR	CE	PTVS51VS1UTR	CZ
PTVS14VS1UTR	CF	PTVS54VS1UTR	D1
PTVS15VS1UTR	CG	PTVS58VS1UTR	D2
PTVS16VS1UTR	CH	PTVS60VS1UTR	D3
PTVS17VS1UTR	CJ	PTVS64VS1UTR	D4
PTVS18VS1UTR	CK	-	-

5. Limiting values

Table 5. Limiting values

In accordance with the Absolute Maximum Rating System (IEC 60134).

Symbol	Parameter	Conditions	Min	Max	Unit
P_{PPM}	rated peak pulse power		[1][2] -	400	W
I_{PPM}	rated peak pulse current		[1] -	see Table 9 and 10	
I_{FSM}	non-repetitive peak forward current	single half-sine wave; $t_p = 8.3$ ms	-	50	A
T_j	junction temperature		-	185	°C
T_{amb}	ambient temperature		-55	+185	°C
T_{stg}	storage temperature		-65	+185	°C

[1] In accordance with IEC 61643-321 (10/1000 μ s current waveform).

[2] For PTVS3V3S1UTR: $P_{PPM} = 350$ W

Table 6. ESD maximum ratings

$T_{amb} = 25$ °C unless otherwise specified.

Symbol	Parameter	Conditions	Min	Max	Unit
Per diode					
V_{ESD}	electrostatic discharge voltage	IEC 61000-4-2; level 4 (contact discharge)	[1] -	30	kV

[1] Device stressed with ten non-repetitive ElectroStatic Discharge (ESD) pulses.

Table 7. ESD standards compliance

Standard	Conditions
Per diode	
IEC 61000-4-2; level 4 (ESD)	> 15 kV (air); > 8 kV (contact)
MIL-STD-883; class 3B (human body model)	> 8 kV

6. Thermal characteristics

Table 8. Thermal characteristics

Symbol	Parameter	Conditions	Min	Typ	Max	Unit	
$R_{th(j-a)}$	thermal resistance from junction to ambient	in free air	[1]	-	-	220	K/W
			[2]	-	-	130	K/W
			[3]	-	-	70	K/W
$R_{th(j-sp)}$	thermal resistance from junction to solder point		[4]	-	-	18	K/W

[1] Device mounted on an FR4 Printed-Circuit Board (PCB), single-sided copper, tin-plated and standard footprint.

[2] Device mounted on an FR4 PCB, single-sided copper, tin-plated, mounting pad for cathode 1 cm².

[3] Device mounted on a ceramic PCB, Al₂O₃, standard footprint.

[4] Soldering point of cathode tab.

7. Characteristics

Table 9. Characteristics per type; PTVS3V3S1UTR to PTVS7V0S1UTR

$T_j = 25\text{ °C}$ unless otherwise specified.

Type number PTVSxxx S1UTR	Reverse standoff voltage V_{RWM} (V)	Breakdown voltage V_{BR} (V)			Reverse leakage current I_{RM} (μ A)			Clamping voltage V_{CL} (V)		Temperature coefficient S_Z (mV/K)
		$I_R = 10\text{ mA}$			at V_{RWM}		at V_{RWM} $T_j = 150\text{ °C}$	Max	I_{PPM} (A)	$I_Z = 5\text{ mA}$
		Min	Typ	Max	Typ	Max	Typ			Typ
3V3	3.3	5.20	5.60	6.00	5	600	17	8.0	43.8	-1.0
5V0	5.0	6.40	6.70	7.00	5	400	17	9.2	43.5	2.5
6V0	6.0	6.67	7.02	7.37	5	400	17	10.3	38.8	3.2
6V5	6.5	7.22	7.60	7.98	5	250	17	11.2	35.7	3.6
7V0	7.0	7.78	8.20	8.60	3	100	9	12.0	33.3	4.3

Table 10. Characteristics per type; PTVS7V5S1UTR to PTVS64VS1UTR $T_j = 25\text{ °C}$ unless otherwise specified.

Type number PTVSxxx S1UTR	Reverse standoff voltage V_{RWM} (V)	Breakdown voltage V_{BR} (V)			Reverse leakage current I_{RM} (μ A)			Clamping voltage V_{CL} (V)		Temperature coefficient S_Z (mV/K)
		$I_R = 1\text{ mA}$			at V_{RWM}		at V_{RWM} $T_j = 150\text{ °C}$			$I_Z = 5\text{ mA}$
	Max	Min	Typ	Max	Typ	Max	Typ	Max	I_{PPM} (A)	Typ
7V5	7.5	8.33	8.77	9.21	0.2	50	2	12.9	31.0	5.0
8V0	8.0	8.89	9.36	9.83	0.03	25	2	13.6	29.4	5.5
8V5	8.5	9.44	9.92	10.40	0.01	10	0.5	14.4	27.8	6.5
9V0	9.0	10.00	10.55	11.10	0.005	5	0.5	15.4	26.0	7.1
10V	10	11.10	11.70	12.30	0.005	2.5	0.5	17.0	23.5	8.1
11V	11	12.20	12.85	13.50	0.005	2.5	0.5	18.2	22.0	9.2
12V	12	13.30	14.00	14.70	0.005	2.5	0.5	19.9	20.1	10.3
13V	13	14.40	15.15	15.90	0.001	0.1	0.5	21.5	18.6	11.4
14V	14	15.60	16.40	17.20	0.001	0.1	0.5	23.2	17.2	13.2
15V	15	16.70	17.60	18.50	0.001	0.1	0.5	24.4	16.4	14.1
16V	16	17.80	18.75	19.70	0.001	0.1	0.5	26.0	15.4	15.9
17V	17	18.90	19.90	20.90	0.001	0.1	0.5	27.6	14.5	16.4
18V	18	20.00	21.00	22.10	0.001	0.1	0.5	29.2	13.7	18.5
20V	20	22.20	23.35	24.50	0.001	0.1	0.5	32.4	12.3	20.0
22V	22	24.40	25.60	26.90	0.001	0.1	0.5	35.5	11.3	23.8
24V	24	26.70	28.10	29.50	0.001	0.1	0.5	38.9	10.3	24.9
26V	26	28.90	30.40	31.90	0.001	0.1	0.5	42.1	9.5	29.1
28V	28	31.10	32.80	34.40	0.001	0.1	0.5	45.4	8.8	30.6
30V	30	33.30	35.10	36.80	0.001	0.1	0.5	48.4	8.3	34.4
33V	33	36.70	38.70	40.60	0.001	0.1	0.5	53.3	7.5	37.5
36V	36	40.00	42.10	44.20	0.001	0.1	0.5	58.1	6.9	42.3
40V	40	44.40	46.80	49.10	0.001	0.1	0.5	64.5	6.2	48.1
43V	43	47.80	50.30	52.80	0.001	0.1	0.5	69.4	5.8	51.6
45V	45	50.00	52.65	55.30	0.001	0.1	0.5	72.7	5.5	55.2
48V	48	53.30	56.10	58.90	0.001	0.1	0.5	77.4	5.2	58.2
51V	51	56.70	59.70	62.70	0.001	0.1	0.5	82.4	4.9	62.5
54V	54	60.00	63.15	66.30	0.001	0.1	0.5	87.1	4.6	66.1
58V	58	64.40	67.80	71.20	0.001	0.1	0.5	93.6	4.3	71.4
60V	60	66.70	70.20	73.70	0.001	0.1	0.5	96.8	4.1	74.1
64V	64	71.10	74.85	78.60	0.001	0.1	0.5	103.0	3.9	80.0

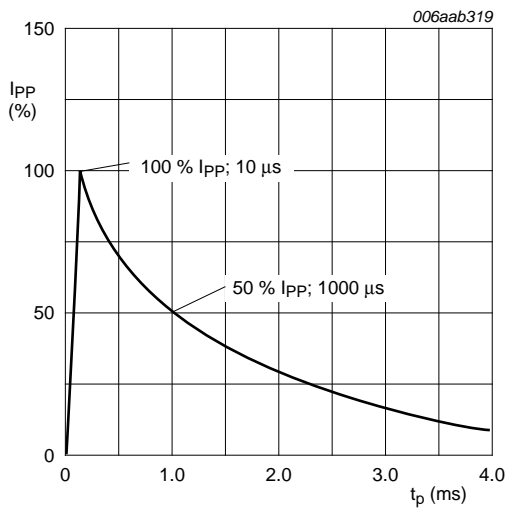

Fig 1. 10/1000 μ s pulse waveform according to IEC 61643-321

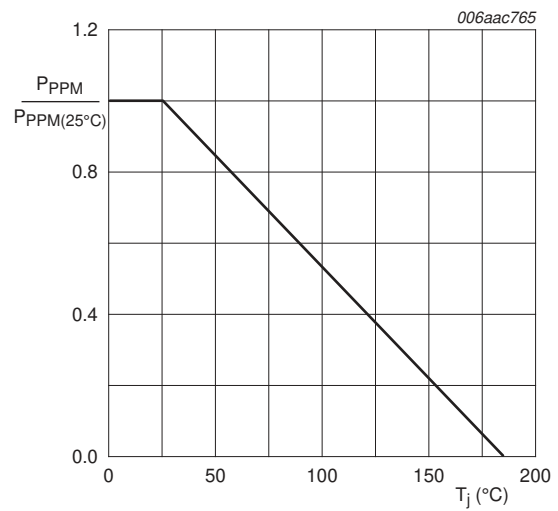
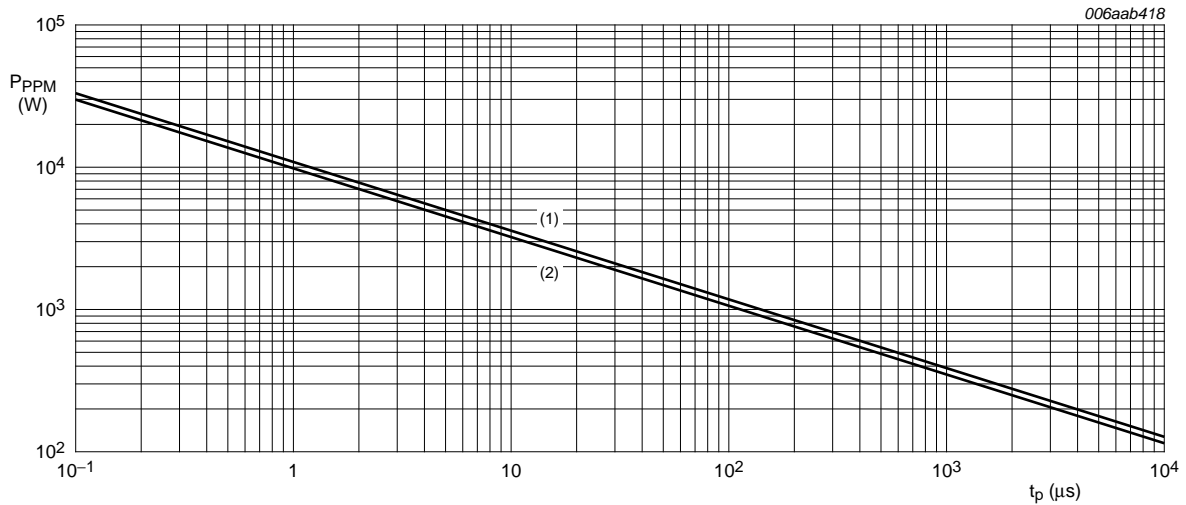
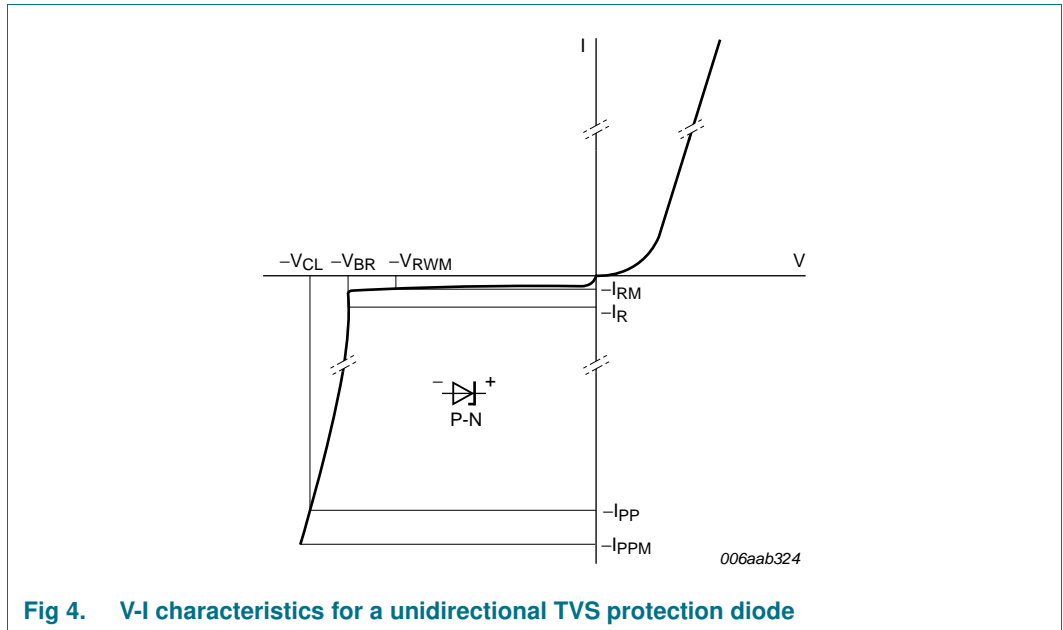

Fig 2. Relative variation of rated peak pulse power as a function of junction temperature; typical values



$T_{amb} = 25^\circ\text{C}$
 (1) PTVS5V0S1UTR to PTVS64VS1UTR
 (2) PTVS3V3S1UTR

Fig 3. Rated peak pulse power as a function of pulse duration; typical values



8. Test information

8.1 Quality information

This product has been qualified in accordance with the Automotive Electronics Council (AEC) standard Q101 - *Stress test qualification for discrete semiconductors*, and is suitable for use in automotive applications.

9. Package outline

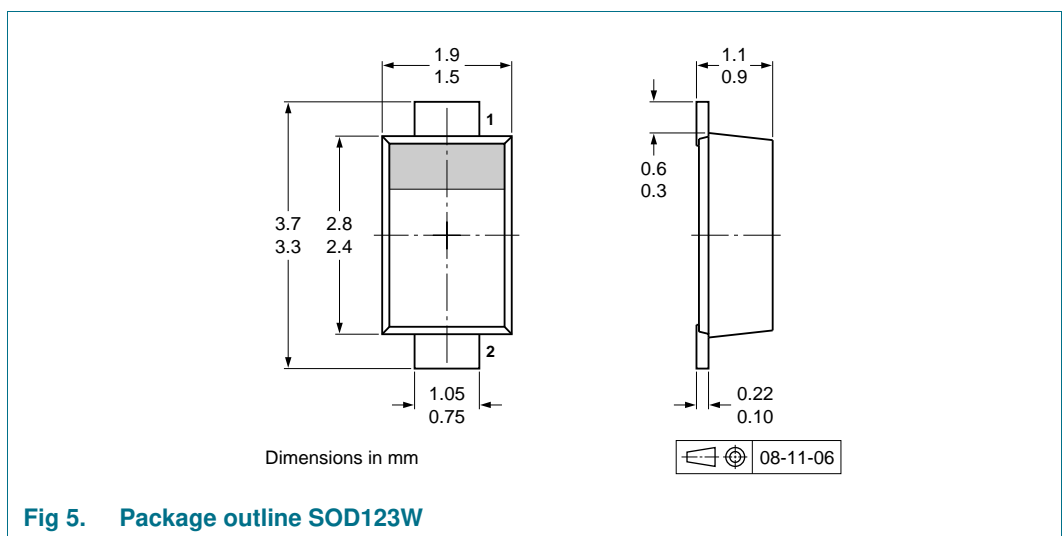

10. Packing information

Table 11. Packing methods

The indicated -xxx are the last three digits of the 12NC ordering code.^[1]

Type number ^[2]	Package	Description	Packing quantity
PTVSxS1UTR series	SOD123W	4 mm pitch, 8 mm tape and reel	3000
			-115

[1] For further information and the availability of packing methods, see [Section 14](#).

[2] The series consists of 35 types with reverse standoff voltages from 3.3 V to 64 V.

11. Soldering

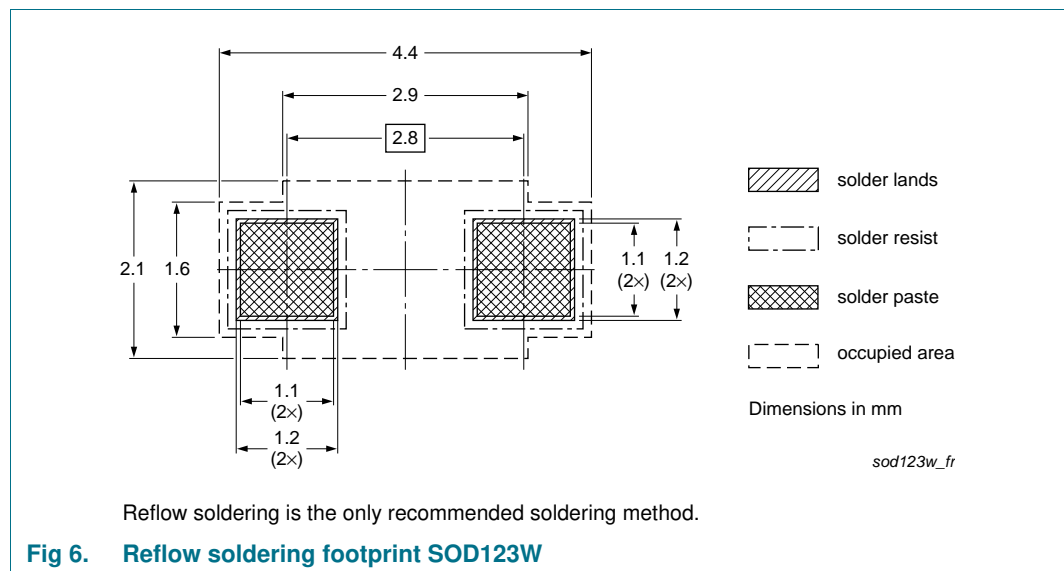

12. Revision history

Table 12. Revision history

Document ID	Release date	Data sheet status	Change notice	Supersedes
PTVSXS1UTR_SER v.1	20111011	Product data sheet	-	-

13. Legal information

13.1 Data sheet status

Document status ^{[1][2]}	Product status ^[3]	Definition
Objective [short] data sheet	Development	This document contains data from the objective specification for product development.
Preliminary [short] data sheet	Qualification	This document contains data from the preliminary specification.
Product [short] data sheet	Production	This document contains the product specification.

[1] Please consult the most recently issued document before initiating or completing a design.

[2] The term 'short data sheet' is explained in section "Definitions".

[3] The product status of device(s) described in this document may have changed since this document was published and may differ in case of multiple devices. The latest product status information is available on the Internet at URL <http://www.nexperia.com>.

13.2 Definitions

Draft — The document is a draft version only. The content is still under internal review and subject to formal approval, which may result in modifications or additions. Nexperia does not give any representations or warranties as to the accuracy or completeness of information included herein and shall have no liability for the consequences of use of such information.

Short data sheet — A short data sheet is an extract from a full data sheet with the same product type number(s) and title. A short data sheet is intended for quick reference only and should not be relied upon to contain detailed and full information. For detailed and full information see the relevant full data sheet, which is available on request via the local Nexperia sales office. In case of any inconsistency or conflict with the short data sheet, the full data sheet shall prevail.

Product specification — The information and data provided in a Product data sheet shall define the specification of the product as agreed between Nexperia and its customer, unless Nexperia and customer have explicitly agreed otherwise in writing. In no event however, shall an agreement be valid in which the Nexperia product is deemed to offer functions and qualities beyond those described in the Product data sheet.

13.3 Disclaimers

Limited warranty and liability — Information in this document is believed to be accurate and reliable. However, Nexperia does not give any representations or warranties, expressed or implied, as to the accuracy or completeness of such information and shall have no liability for the consequences of use of such information.

In no event shall Nexperia be liable for any indirect, incidental, punitive, special or consequential damages (including - without limitation - lost profits, lost savings, business interruption, costs related to the removal or replacement of any products or rework charges) whether or not such damages are based on tort (including negligence), warranty, breach of contract or any other legal theory.

Notwithstanding any damages that customer might incur for any reason whatsoever, Nexperia's aggregate and cumulative liability towards customer for the products described herein shall be limited in accordance with the *Terms and conditions of commercial sale* of Nexperia.

Right to make changes — Nexperia reserves the right to make changes to information published in this document, including without limitation specifications and product descriptions, at any time and without notice. This document supersedes and replaces all information supplied prior to the publication hereof.

Suitability for use — Nexperia products are not designed, authorized or warranted to be suitable for use in life support, life-critical or safety-critical systems or equipment, nor in applications where failure or

malfunction of a Nexperia product can reasonably be expected to result in personal injury, death or severe property or environmental damage. Nexperia accepts no liability for inclusion and/or use of Nexperia products in such equipment or applications and therefore such inclusion and/or use is at the customer's own risk.

Applications — Applications that are described herein for any of these products are for illustrative purposes only. Nexperia makes no representation or warranty that such applications will be suitable for the specified use without further testing or modification.

Customers are responsible for the design and operation of their applications and products using Nexperia products, and Nexperia accepts no liability for any assistance with applications or customer product design. It is customer's sole responsibility to determine whether the Nexperia product is suitable and fit for the customer's applications and products planned, as well as for the planned application and use of customer's third party customer(s). Customers should provide appropriate design and operating safeguards to minimize the risks associated with their applications and products.

Nexperia does not accept any liability related to any default, damage, costs or problem which is based on any weakness or default in the customer's applications or products, or the application or use by customer's third party customer(s). Customer is responsible for doing all necessary testing for the customer's applications and products using Nexperia products in order to avoid a default of the applications and the products or of the application or use by customer's third party customer(s). Nexperia does not accept any liability in this respect.

Limiting values — Stress above one or more limiting values (as defined in the Absolute Maximum Ratings System of IEC 60134) will cause permanent damage to the device. Limiting values are stress ratings only and (proper) operation of the device at these or any other conditions above those given in the Recommended operating conditions section (if present) or the Characteristics sections of this document is not warranted. Constant or repeated exposure to limiting values will permanently and irreversibly affect the quality and reliability of the device.

Terms and conditions of commercial sale — Nexperia products are sold subject to the general terms and conditions of commercial sale, as published at <http://www.nexperia.com/profile/terms>, unless otherwise agreed in a valid written individual agreement. In case an individual agreement is concluded only the terms and conditions of the respective agreement shall apply. Nexperia hereby expressly objects to applying the customer's general terms and conditions with regard to the purchase of Nexperia products by customer.

No offer to sell or license — Nothing in this document may be interpreted or construed as an offer to sell products that is open for acceptance or the grant, conveyance or implication of any license under any copyrights, patents or other industrial or intellectual property rights.

Export control — This document as well as the item(s) described herein may be subject to export control regulations. Export might require a prior authorization from competent authorities.

Quick reference data — The Quick reference data is an extract of the product data given in the Limiting values and Characteristics sections of this document, and as such is not complete, exhaustive or legally binding.

13.4 Trademarks

Notice: All referenced brands, product names, service names and trademarks are the property of their respective owners.

14. Contact information

For more information, please visit: <http://www.nexperia.com>

For sales office addresses, please send an email to: salesaddresses@nexperia.com

15. Contents

1	Product profile	1
1.1	General description	1
1.2	Features and benefits	1
1.3	Applications	1
1.4	Quick reference data	1
2	Pinning information	2
3	Ordering information	2
4	Marking	2
5	Limiting values	3
6	Thermal characteristics	4
7	Characteristics	4
8	Test information	7
8.1	Quality information	7
9	Package outline	7
10	Packing information	8
11	Soldering	8
12	Revision history	9
13	Legal information	10
13.1	Data sheet status	10
13.2	Definitions	10
13.3	Disclaimers	10
13.4	Trademarks	11
14	Contact information	11
15	Contents	12