

NCS2564

Four-Channel Video Driver with Selectable SD / HD Reconstruction Filters

The NCS2564 is a 4-channel high speed video driver with 6th order Butterworth Reconstruction filters on each channel. A first set of 3-channel has selectable Standard Definition (SD) / High Definition (HD) filters, one per channel. A fourth channel offers an extra filter driver for driving CVBS-type video signal. The NCS2564 is in fact a combination of a triple SD/HD video driver plus a single CVBS video driver.

It is designed to be compatible with Digital-to-Analog Converters (DAC) embedded in most video processors.

To further reduce power consumption, 2 enable pins are provided one for the triple driver and another one for the single driver. One pin allows selecting the filter frequency of the triple driver. All channels can accept DC- or AC-coupled signals. In case of AC-coupled inputs, the internal clamps are enabled. The outputs can drive both AC and DC coupled 150 Ω loads.

Features

- 3-Channel with per Channel a Selectable Sixth-Order Butterworth 8/34 MHz Filter
- One CVBS Driver Including 6th Order Butterworth 8 MHz Filter
- Transparent Clamp
- Internal Fixed Gain: 6 dB ± 0.2
- Integrated Level Shifter
- AC- or DC-Coupled Inputs and Outputs
- Low Quiescent Current
- Shutdown Current 42 μA Typical (Disabled)
- Each channel Capable to Drive 2 by 150 Ω Loads
- Wide Operating Supply Voltage Range: +4.7 V to +5.3 V
- 8 kV ESD Protection (IEC61000-4-2 Compatible)
- TSSOP-14 Package
- These are Pb-Free Devices

Typical Application

- Set Top Box Decoder
- DVD Player / Recorder
- HDTV



ON Semiconductor®

<http://onsemi.com>

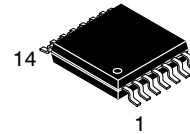

TSSOP-14
TBD SUFFIX
CASE 948G

MARKING DIAGRAM

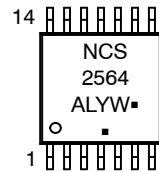

- NCS2564 = Specific Device Code
- A = Assembly Location
- L = Wafer Lot
- Y = Year
- W = Work Week
- = Pb-Free Package

PINOUT

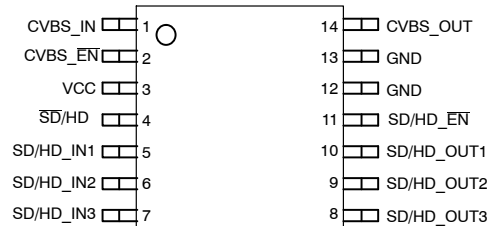

(Top View)

ORDERING INFORMATION

Device	Package	Shipping†
NCS2564DTBR2G	TSSOP-14 (Pb-Free)	2500 / Tape & Reel

†For information on tape and reel specifications, including part orientation and tape sizes, please refer to our Tape and Reel Packaging Specifications Brochure, BRD8011/D.

NCS2564

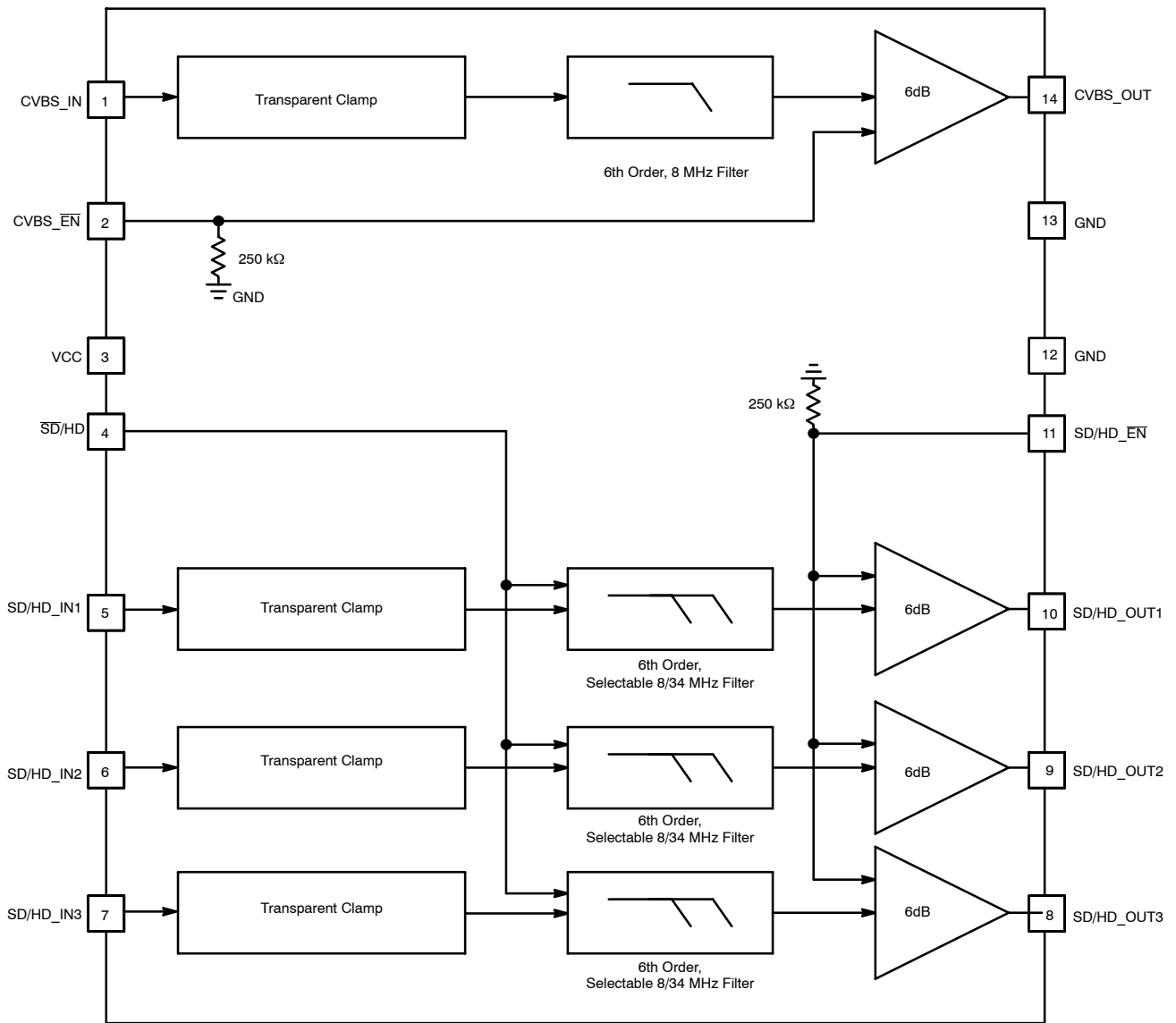

Figure 1. NCS2564 Block Diagram

NCS2564

PIN DESCRIPTION

Pin No.	Name	Type	Description
1	CVBS_IN	Input	Video Input for Video Signal featuring a frequency bandwidth compatible with NTSC / PAL / SECAM Video (8 MHz) – CVBS Channel
2	CVBS_EN	Input	CVBS Channel Enable /Disable Function: Low = Enable, High = Disable. When left open the default state is Enable.
3	VCC	Power	Power Supply / 4.7 V to 5.3 V
4	$\overline{SD/HD}$	Input	Pin of selection enabling the Standard Definition or High Definition Filters (8 MHz / 34 MHz) for channels SD/HD – when Low SD filters are selected, when High HD filters are selected.
5	SD/HD_IN1	Input	Selectable SD or HD Video Input 1 – SD/HD Channel 1
6	SD/HD_IN2	Input	Selectable SD or HD Video Input 2 – SD/HD Channel 2
7	SD/HD_IN3	Input	Selectable SD or HD Video Input 3 – SD/HD Channel 3
8	SD/HD_OUT3	Output	SD/HD Video Output 3 – SD/HD Channel 3
9	SD/HD_OUT2	Output	SD/HD Video Output 2 – SD/HD Channel 2
10	SD/HD_OUT1	Output	SD/HD Video Output 1 – SD/HD Channel 1
11	SD/HD_EN	Input	SD/HD Channel Enable/Disable Function: Low = Enable, High = Disable. When left open the default state is Enable.
12	GND	Ground	Ground
13	GND	Ground	Ground
14	CVBS_OUT	Output	CVBS Video Output – CVBS Channel

MAXIMUM RATINGS

Rating	Symbol	Value	Unit
Power Supply Voltages	V_{CC}	$-0.3 \leq V_{CC} \leq 5.5$	Vdc
I/O Voltage Range	V_{IO}	$-0.3 \leq V_I \leq V_{CC}$	Vdc
Input Differential Voltage Range	V_{ID}	$-0.3 \leq V_I \leq V_{CC}$	Vdc
Output Current (Indefinitely) per Channel	I_O	40	mA
Maximum Junction Temperature (Note 1)	T_J	150	°C
Operating Ambient Temperature	T_A	-40 to +85	°C
Storage Temperature Range	T_{stg}	-60 to +150	°C
Thermal Resistance, Junction-to-Air	$R_{\theta JA}$	125	°C/W
ESD Protection Voltage (IEC61000-4-2)	V_{esd}	>8000	V
ESD HBM – Human Body Model	HBM	4000	V

Stresses exceeding Maximum Ratings may damage the device. Maximum Ratings are stress ratings only. Functional operation above the Recommended Operating Conditions is not implied. Extended exposure to stresses above the Recommended Operating Conditions may affect device reliability.

1. Power dissipation must be considered to ensure maximum junction temperature (T_J) is not exceeded.

Maximum Power Dissipation

The maximum power that can be safely dissipated is limited by the associated rise in junction temperature. For the plastic packages, the maximum safe junction temperature is 150°C. If the maximum is exceeded momentarily, proper circuit operation will be restored as soon as the die temperature is reduced. Leaving the device in the “overheated” condition for an extended period can result in device burnout. To ensure proper operation, it is important to observe the derating curves.

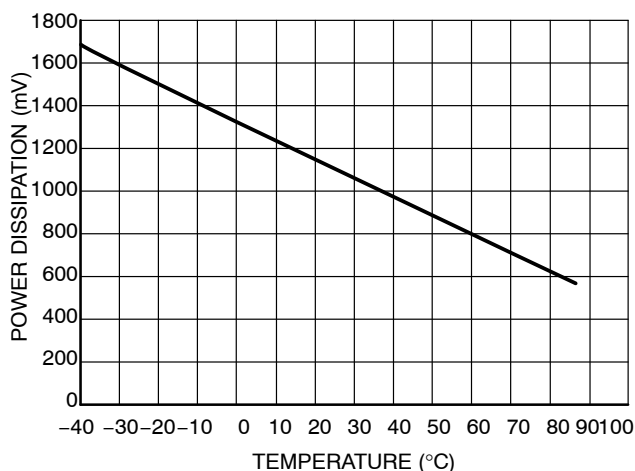

Figure 2. Power Dissipation vs Temperature

NCS2564

DC ELECTRICAL CHARACTERISTICS ($V_{CC} = +5.0\text{ V}$, $R_{source} = 37.5\ \Omega$, $T_A = 25^\circ\text{C}$, inputs AC-coupled with $0.1\ \mu\text{F}$, all outputs AC-coupled with $220\ \mu\text{F}$ into $150\ \Omega$ referenced to $400\ \text{kHz}$; unless otherwise specified)

Symbol	Characteristics	Conditions	Min	Typ	Max	Unit
POWER SUPPLY						
V_{CC}	Supply Voltage Range		4.7	5.0	5.3	V
I_{CC}	Supply Current	SD Channels Selected + C_{vbs} HD Channels Selected + C_{vbs}		40 50	55 70	mA
I_{SD}	Shutdown Current (CVBS_EN and SD/HD_EN High)			42	60	μA

DC PERFORMANCE

V_i	Input Common Mode Voltage Range		GND		1.4	V_{PP}
V_{IL}	Input Low Level for the Control Pins (2, 4, 11)		0		0.8	V
V_{IH}	Input High Level for the Control Pins (2, 4, 11)		2.4		V_{CC}	V
R_{pd}	Pulldown Resistors on Pins CVBS_EN and SD/HD_EN			250		k Ω

OUTPUT CHARACTERISTICS

V_{OH}	Output Voltage High Level			2.8		V
V_{OL}	Output Voltage Low Level			200		mV
I_O	Output Current			40		mA

AC ELECTRICAL CHARACTERISTICS FOR STANDARD DEFINITION CHANNELS (pin numbers (1, 14) (5, 10), (6, 9), (7, 8)) ($V_{CC} = +5.0\text{ V}$, $V_{in} = 1\text{ V}_{PP}$, $R_{source} = 37.5\ \Omega$, $T_A = 25^\circ\text{C}$, inputs AC-coupled with $0.1\ \mu\text{F}$, all outputs AC-coupled with $220\ \mu\text{F}$ into $150\ \Omega$ referenced to $400\ \text{kHz}$; unless otherwise specified, $\overline{SD/HD} = \text{Low}$)

Symbol	Characteristics	Conditions	Min	Typ	Max	Unit
A_{VSD}	Voltage Gain	$V_{in} = 1\text{ V}$ – All SD Channels	5.8	6.0	6.2	dB
BW_{SD}	Low Pass Filter Bandwidth (Note 3)	-1 dB -3 dB	5.5 6.5	7.2 8.0		MHz
A_{RSD}	Stop-band Attenuation (Notes 3 and 4)	@ 27 MHz	43	50		dB
dG_{SD}	Differential Gain Error			0.7		%
$d\Phi_{SD}$	Differential Phase Error			0.7		$^\circ$
THD	Total Harmonic Distortion	$V_{out} = 1.4\text{ V}_{PP}$ @ 3.58 MHz		0.35		%
X_{SD}	Channel-to-Channel Crosstalk	@ 1 MHz and $V_{in} = 1.4\text{ V}_{PP}$		-57		dB
SNR_{SD}	Signal-to-Noise Ratio	NTC-7 Test Signal, 100 kHz to 4.2 MHz (Note 2)		72		dB
Δt_{SD}	Propagation Delay	@ 4.5 MHz		70		ns
ΔGD_{SD}	Group Delay Variation	100 kHz to 8 MHz		20		ns

2. $SNR = 20 \times \log(714\text{ mV} / \text{RMS noise})$

3. 100% of Tested ICs fit the bandwidth and attenuation tolerance at 25°C .

4. Guaranteed by characterization.

NCS2564

AC ELECTRICAL CHARACTERISTICS FOR HIGH DEFINITION CHANNELS (pin numbers (5, 10) (6, 9), (7, 8))

($V_{CC} = +5.0\text{ V}$, $V_{in} = 1\text{ V}_{PP}$, $R_{source} = 37.5\ \Omega$, $T_A = 25^\circ\text{C}$, inputs AC-coupled with $0.1\ \mu\text{F}$, all outputs AC-coupled with $220\ \mu\text{F}$ into $150\ \Omega$ referenced to 400 kHz; unless otherwise specified, $\overline{\text{SD}}/\text{HD} = \text{High}$)

Symbol	Characteristics	Conditions	Min	Typ	Max	Unit
A_{VHD}	Voltage Gain	$V_{in} = 1\text{ V}$ – All HD Channels	5.8	6.0	6.2	dB
BW_{HD}	Low Pass Filter Bandwidth	-1 dB (Note 6) -3 dB (Note 7)	26 30	31 34		MHz
A_{RHD}	Stop-band Attenuation	@ 44.25 MHz (Note 7) @ 74.25 MHz (Note 6)	33	15 42		dB
THD_{HD}	Total Harmonic Distortion	$V_{out} = 1.4\text{ V}_{PP}$ @ 10 MHz $V_{out} = 1.4\text{ V}_{PP}$ @ 15 MHz $V_{out} = 1.4\text{ V}_{PP}$ @ 20 MHz		0.4 0.6 0.8		%
X_{HD}	Channel-to-Channel Crosstalk	@ 1 MHz and $V_{in} = 1.4\text{ V}_{PP}$		-60		dB
SNR_{HD}	Signal-to-Noise Ratio	White Signal, 100 kHz to 30 MHz, (Note 5)		72		dB
Δt_{HD}	Propagation Delay			25		ns
ΔGD_{HD}	Group Delay Variation from 100 kHz to 30 MHz			10		ns

5. $SNR = 20 \times \log(714\text{ mV} / \text{RMS noise})$

6. Guaranteed by Characterization.

7. 100% of Tested ICs fit the bandwidth and attenuation tolerance at 25°C .

TYPICAL CHARACTERISTICS

$V_{CC} = +5.0\text{ V}$, $V_{in} = 1\text{ V}_{PP}$, $R_{source} = 37.5\ \Omega$, $T_A = 25^\circ\text{C}$, Inputs AC-coupled with $0.1\ \mu\text{F}$, All Outputs AC-coupled with $220\ \mu\text{F}$ into $150\ \Omega$
 Referenced to 400 kHz; unless otherwise specified

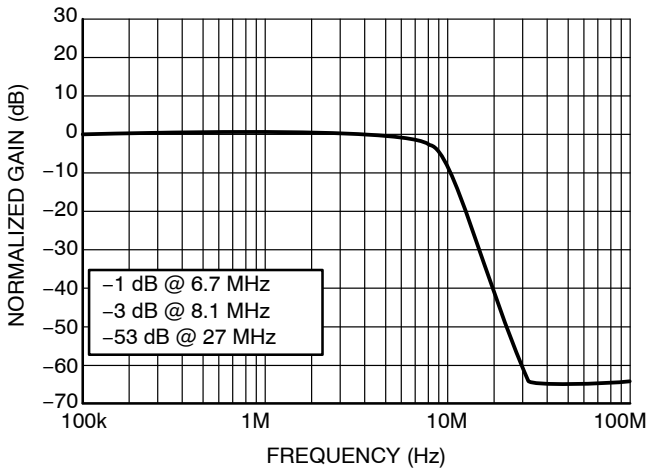

Figure 3. SD Normalized Frequency Response

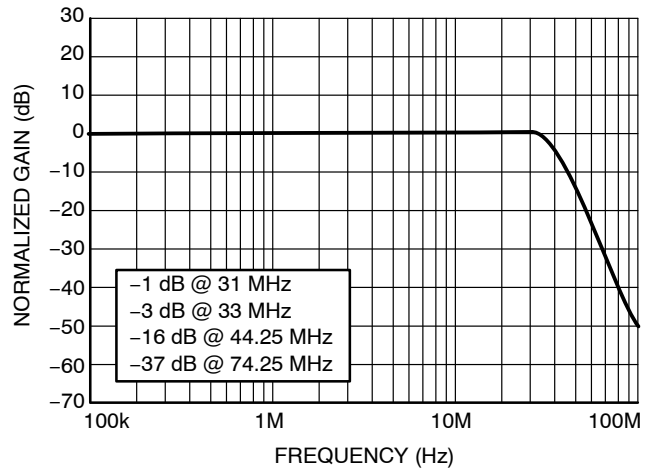

Figure 4. HD Normalized Frequency Response

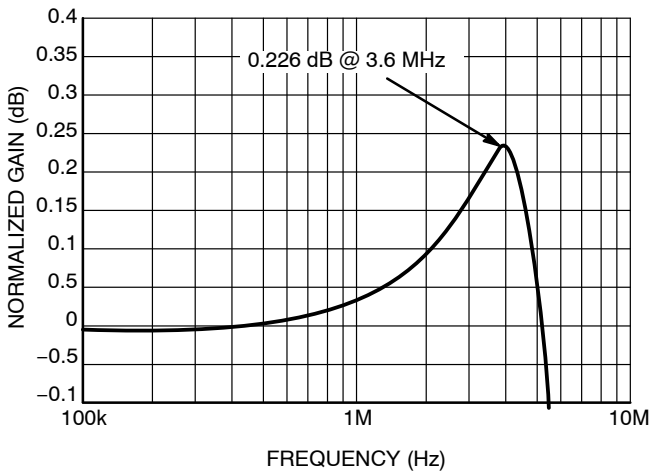

Figure 5. SD Passband Flatness

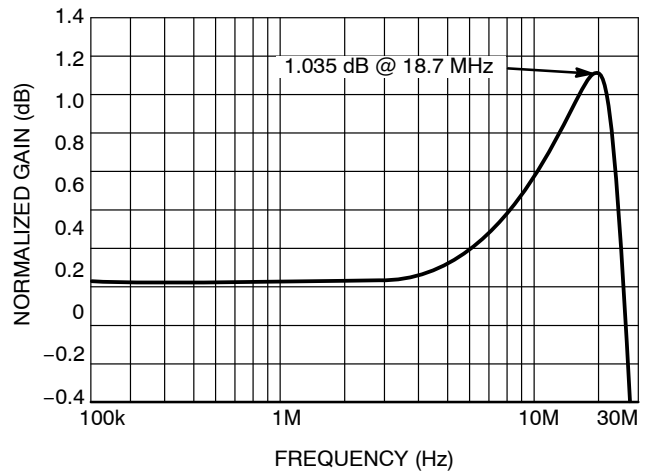

Figure 6. HD Passband Flatness

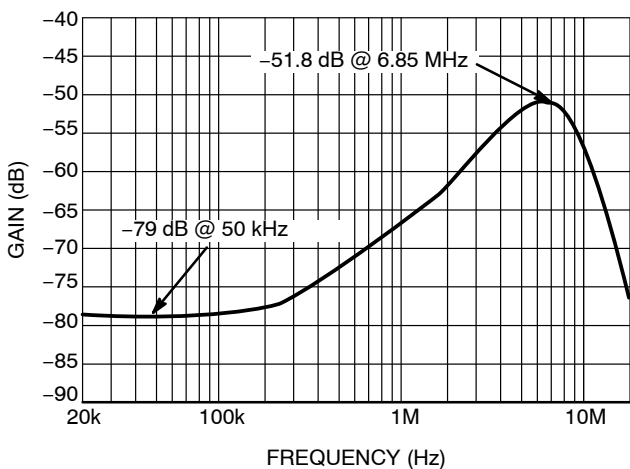

Figure 7. SD Channel-to-Channel Crosstalk

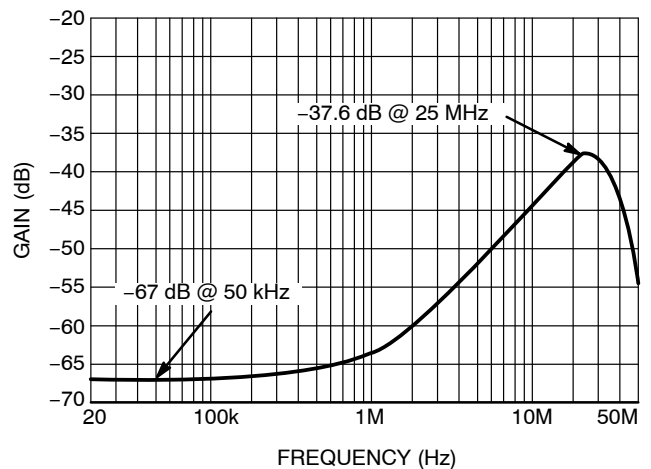

Figure 8. HD Channel-to-Channel Crosstalk

TYPICAL CHARACTERISTICS

$V_{CC} = +5.0\text{ V}$, $V_{in} = 1\text{ V}_{PP}$, $R_{source} = 37.5\ \Omega$, $T_A = 25^\circ\text{C}$, Inputs AC-coupled with $0.1\ \mu\text{F}$, All Outputs AC-coupled with $220\ \mu\text{F}$ into $150\ \Omega$
 Referred to 400 kHz; unless otherwise specified

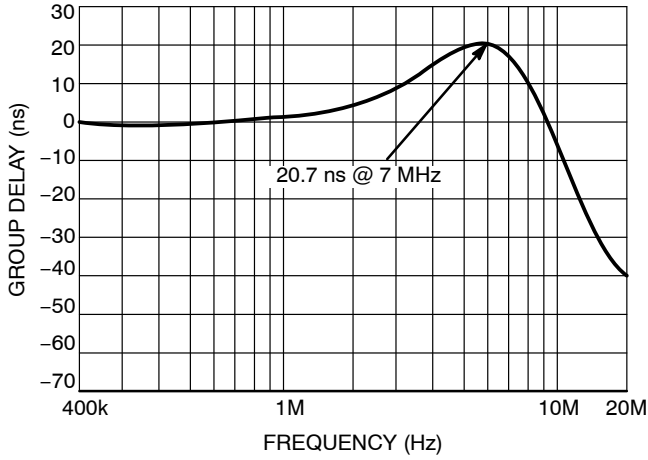

Figure 9. SD Normalized Group Delay

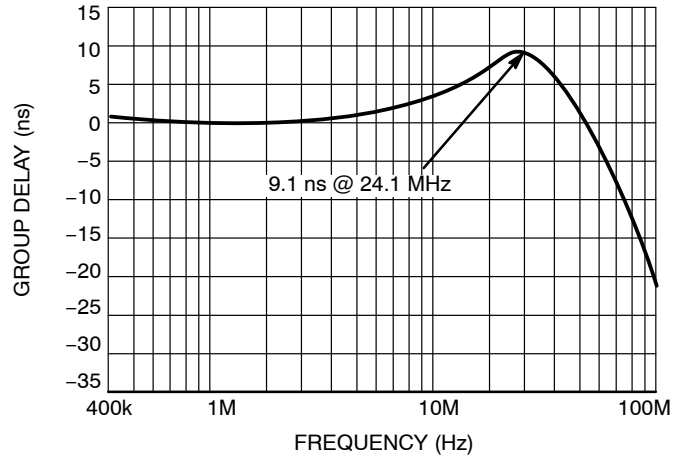

Figure 10. HD Normalized Group Delay

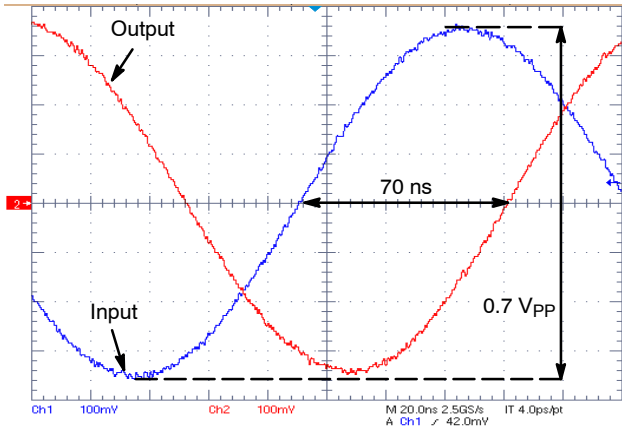

Figure 11. SD Propagation Delay

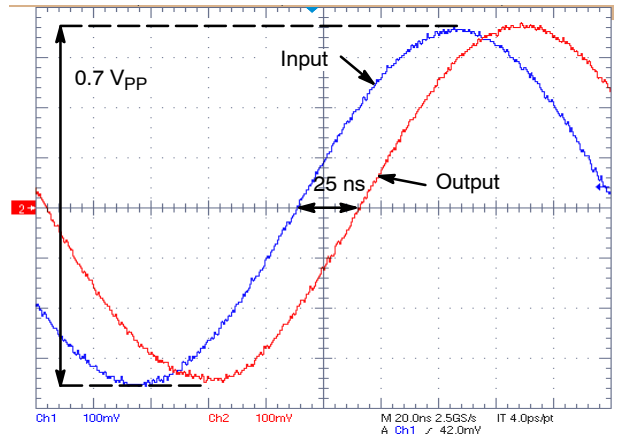

Figure 12. HD Propagation Delay

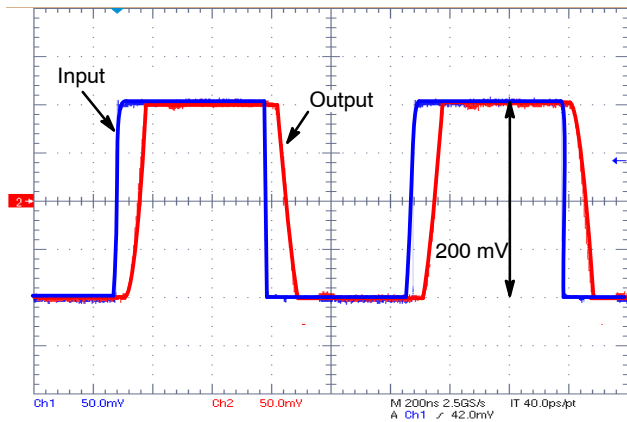

Figure 13. SD Small Signal Response

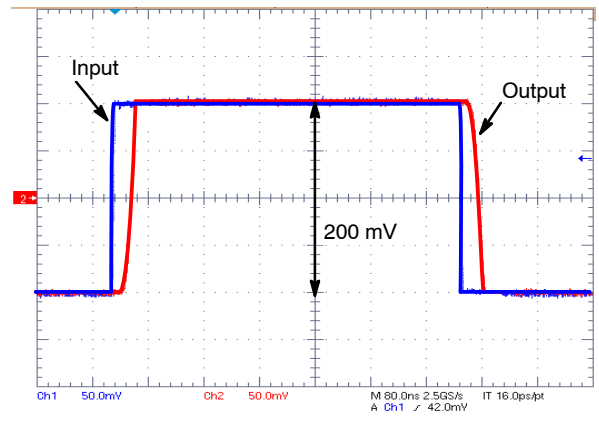

Figure 14. HD Small Signal Response

NCS2564

TYPICAL CHARACTERISTICS

$V_{CC} = +5.0\text{ V}$, $V_{in} = 1\text{ V}_{PP}$, $R_{source} = 37.5\ \Omega$, $T_A = 25^\circ\text{C}$, Inputs AC-coupled with $0.1\ \mu\text{F}$, All Outputs AC-coupled with $220\ \mu\text{F}$ into $150\ \Omega$
Referenced to 400 kHz; unless otherwise specified

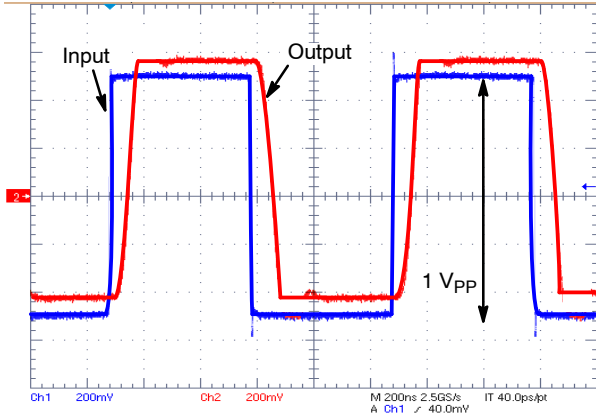

Figure 15. SD Large Signal Response

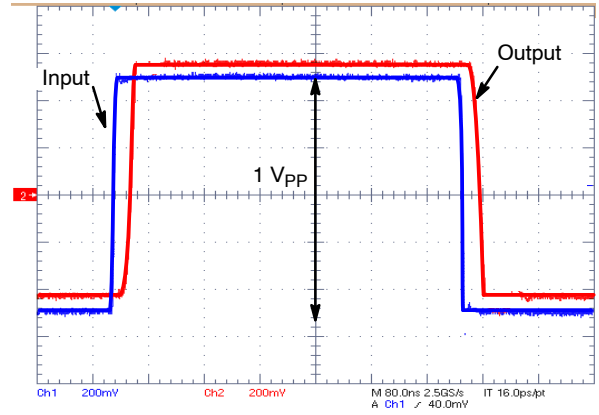

Figure 16. HD Large Signal Response

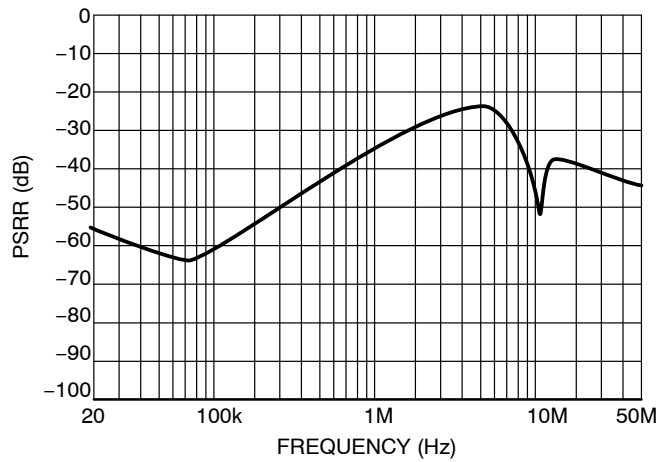

Figure 17. SD and HD V_{CC} PSRR vs. Frequency

TYPICAL CHARACTERISTICS

$V_{CC} = +5.0\text{ V}$, $V_{in} = 1\text{ V}_{PP}$, $R_{source} = 37.5\ \Omega$, $T_A = 25^\circ\text{C}$, Inputs AC-coupled with $0.1\ \mu\text{F}$, All Outputs AC-coupled with $220\ \mu\text{F}$ into $150\ \Omega$
 Referred to 400 kHz; unless otherwise specified

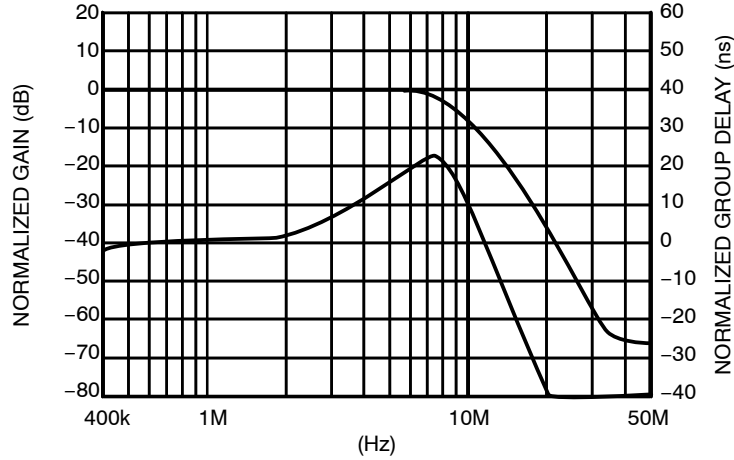

Figure 18. SD Frequency Response and Group Delay

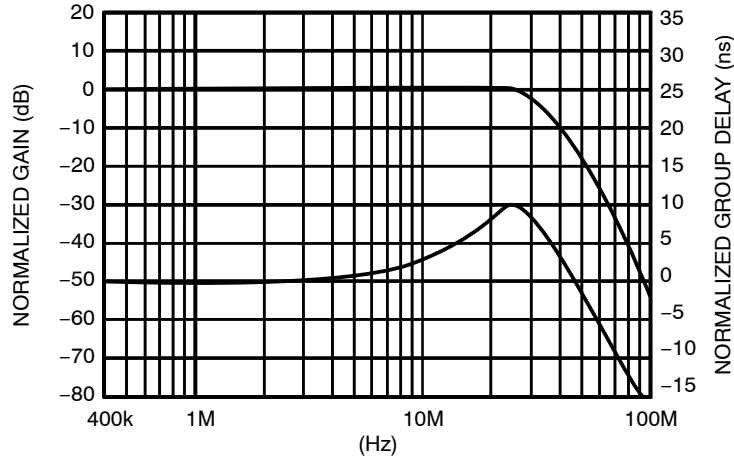

Figure 19. HD Frequency Response and Group Delay

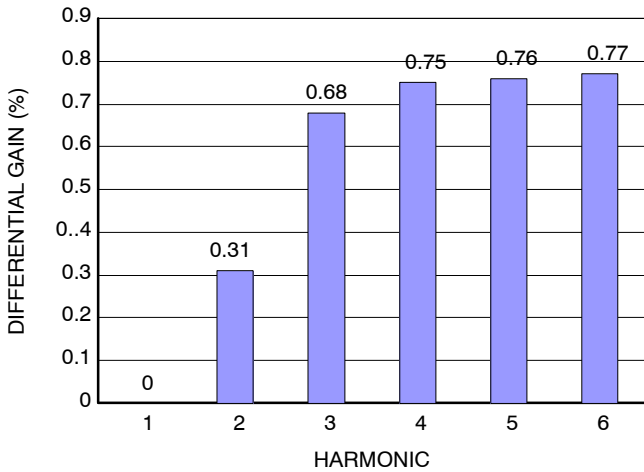

Figure 20. SD Differential Gain

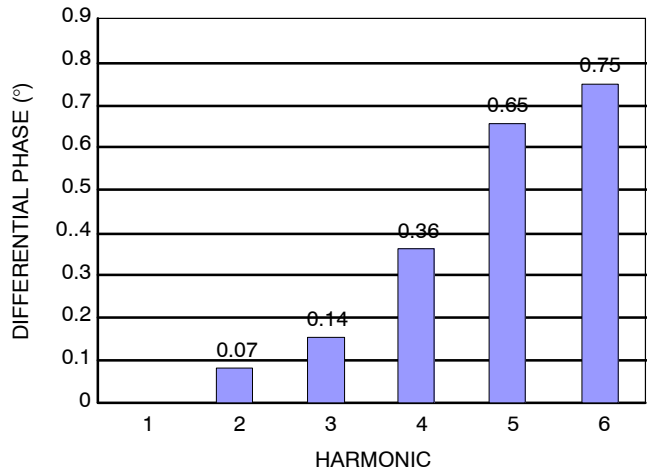

Figure 21. SD Differential Phase

APPLICATIONS INFORMATION

The NCS2564 quad video driver has been optimized for Standard and High Definition video applications covering the requirements of the standards Composite video (CVBS), S-Video, Component Video (480i/525i, 576i/625i, 720p/1080i) and related (RGB). The three SD/HD channels have selectable filters (8 MHz and 34 MHz) for covering either standard definition-like video applications or High Definition video applications. These frequencies are selectable using the pin $\overline{\text{SD/HD}}$.

In the regular mode of operation each channel provides an internal voltage-to-voltage gain of 2 from input to output. This effectively reduces the number of external components

required as compared to discrete approached implemented with stand alone op amps. An internal level shifter is employed shifting up the output voltage by adding an offset of 200 mV. This prevents sync pulse clipping and allows DC-coupled output to the 150 Ω video load. In addition, the NCS2564 integrates a 6th order Butterworth filter for each. This allows rejection of the aliases or unwanted over-sampling effects produced by the video DAC. Similarly for the case of DVD recorders which use an ADC, this anti-aliasing filter (reconstruction filter) will avoid picture quality issue and will aid filtration of parasitic signals caused by EMI interference.

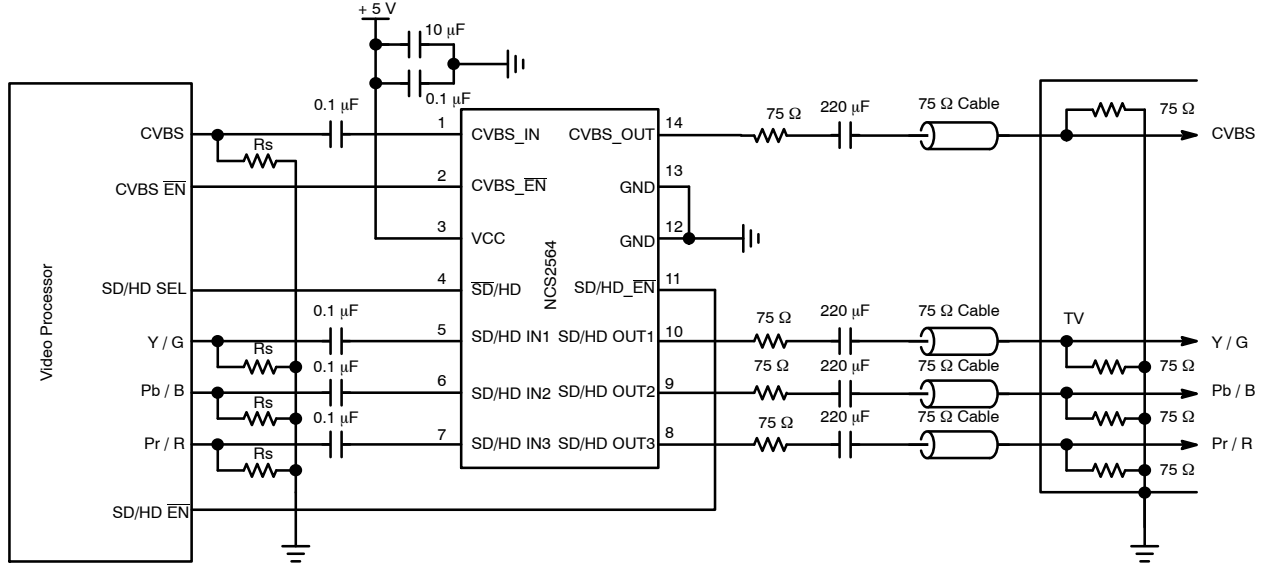

Figure 22. AC-Coupled Configuration at the Input and Output

A built-in diode-like clamp is used into the chip for each channel to support the AC-coupled mode of operation. The clamp is active when the input signal goes below 0 V.

The built-in clamp and level shifter allow the device to operate in different configuration modes depending on the DAC output signal level and the input common mode voltage of the video driver. When the configuration is DC-Coupled at the Inputs and Outputs the 0.1 μF and 220 μF coupling capacitors are no longer used, and the clamps are in that case inactive; this configuration provides a low cost solution which can be implemented with few external components (Figure 23).

The input is AC-coupled when either the input-signal amplitude goes over the range 0 V to 1.4 V or the video source requires such a coupling. In some circumstances it may be necessary to auto-bias signals with the addition of a pullup and pulldown resistors or only pullup resistor (Typical 7.5 M Ω combined with the internal 800 k Ω pulldown) making the clamp inactive.

The output AC-coupling configuration is advantageous for eliminating DC ground loop with the drawback of making the device more sensitive to video line or field tilt issues in the case of a too low output coupling capacitor. In

some cases it may be necessary to increase the nominal 220 μF capacitor value.

Shutdown Mode

If the enable pins are left open by default the circuit will be enabled. The Enable pin offers a shutdown function, so the NCS2564 can consequently be disabled when not used. The NCS2564's quiescent current reduces to 42 μA typical during shutdown mode.

DC-Coupled Output

The outputs of the NCS2564 can be DC-coupled to a 150 Ω load (Figure 23). This has the advantage of eliminating the AC-coupling capacitors at the output by reducing the number of external components and saving space on the board. This can be a key advantage for some applications with limited space.

The problems of field tilt effects on the video signal are also eliminated providing the best video quality with optimal dynamic or peak-to-peak amplitude of the video signal allowing operating thanks to the built-in level shifter without risk of signal clipping. In this coupling configuration the average output voltage is higher than 0 V and the power consumption can be a little higher than with an AC-coupled configuration.

NCS2564

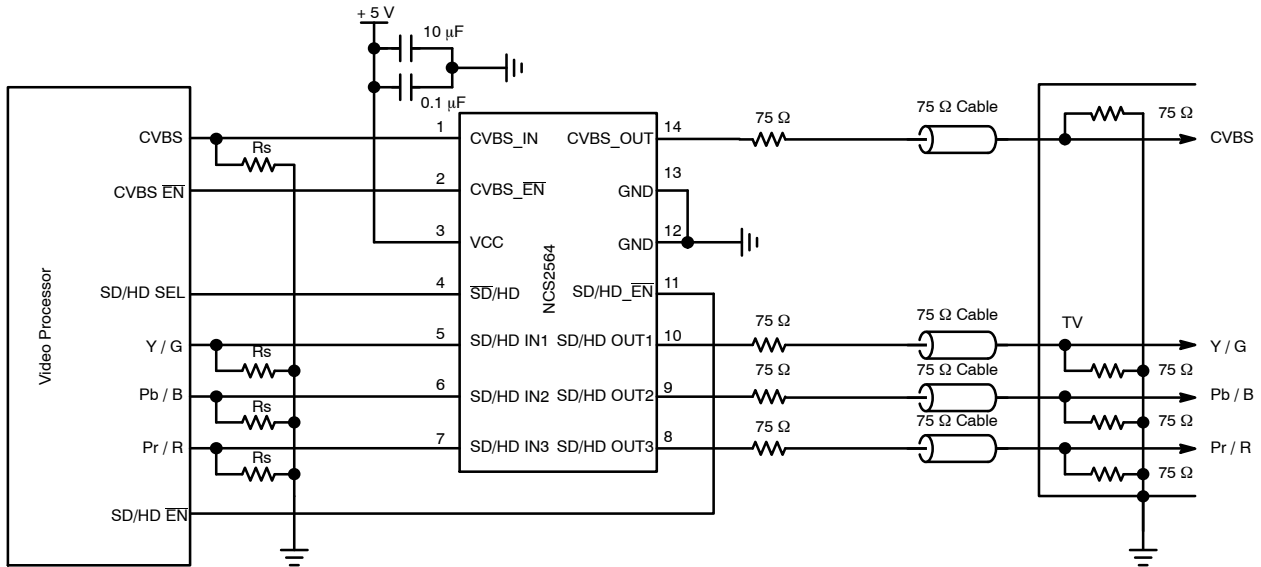

Figure 23. DC-Coupled Input and Output Configuration

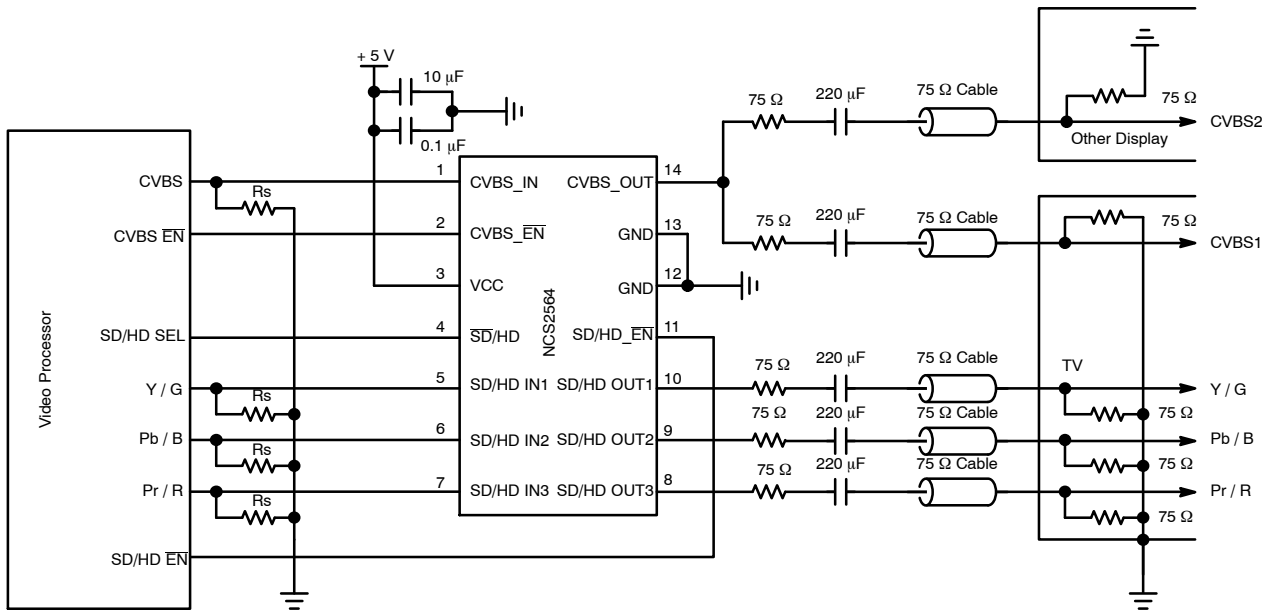

Figure 24. Typical Application

NCS2564

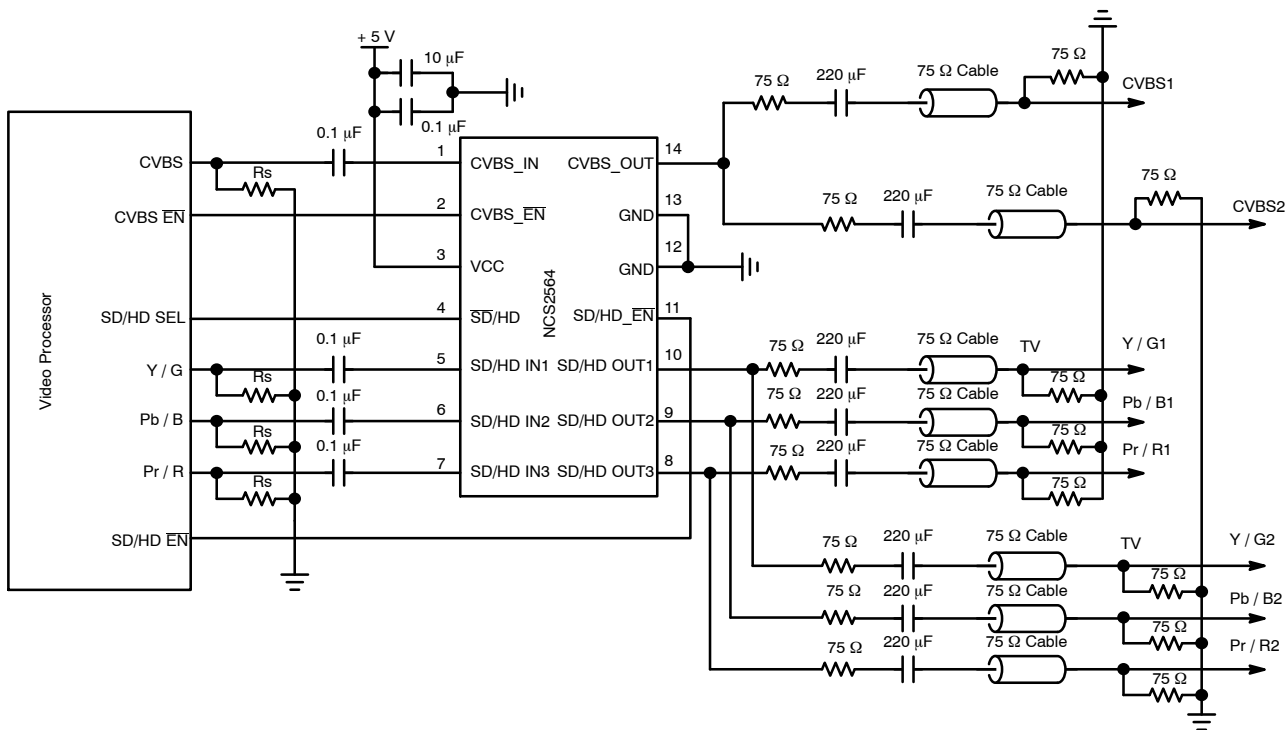

Figure 25. NCS2564 Driving 2 SCARTS Simultaneously

Video Driving Capability

With an output current capability of 40 mA the NCS2564 was designed to be able to drive at least 2 video display loads in parallel. This type of application is illustrated Figure 24. Figure 26 (multiburst) and Figure 27 (linearity) show that the video signal can efficiently drive a 75 Ω equivalent load and not degrade the video performance.

ESD Protection

All the device pins are protected against electrostatic discharge at a level of 4 kV HBM and 8 kV according to IEC61000-4-2. This feature has been considered with a particular attention with ESD structure able to sustain the typical values requested by the systems like Set Top Boxes or Blue-Ray players. This parameter is particularly important for video driver which usually constitutes the last stage in the video chain before the video output connector. The IEC61000-4-2 standard has been used to test our devices in the real application environment. Test methodology can be provided on request.

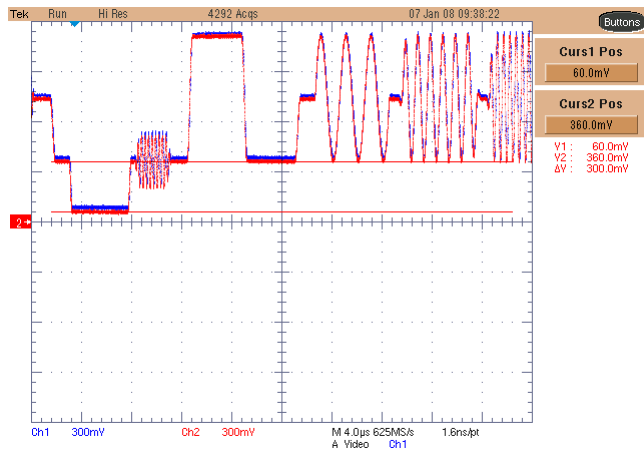

Figure 26. Multiburst Test with Two 150 Ω Loads

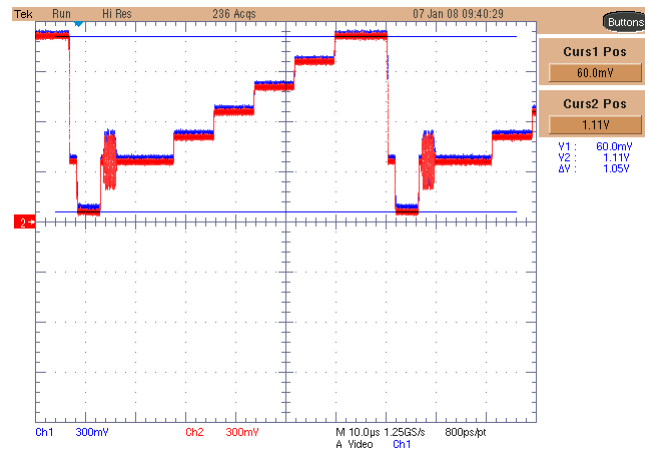
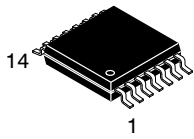

Figure 27. Linearity Test with Two 150 Ω Loads

MECHANICAL CASE OUTLINE PACKAGE DIMENSIONS



TSSOP-14 WB
CASE 948G
ISSUE C

DATE 17 FEB 2016

SCALE 2:1

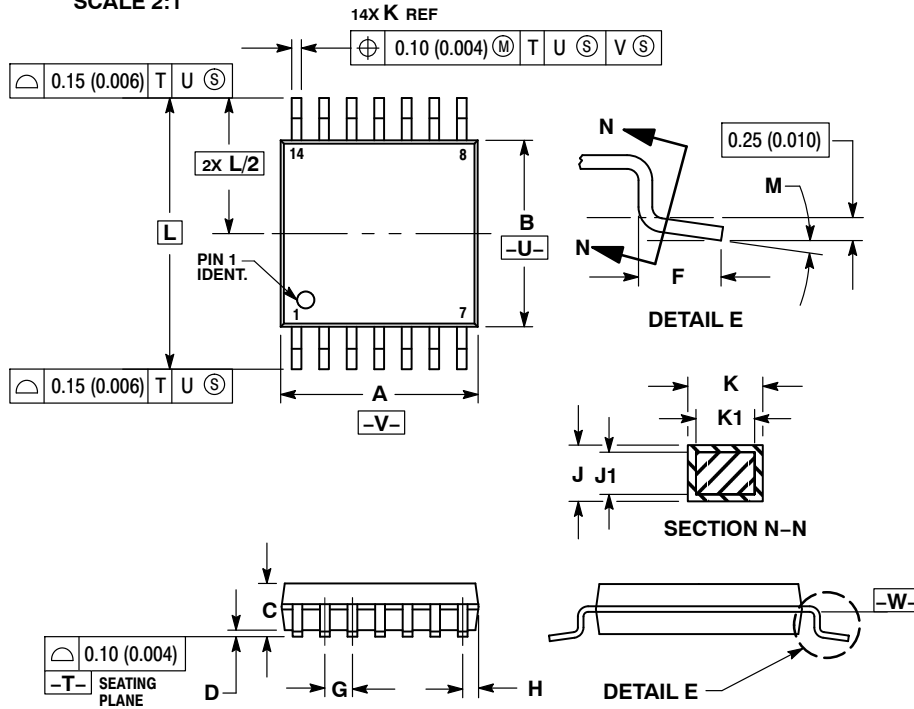

NOTES:

- DIMENSIONING AND TOLERANCING PER ANSI Y14.5M, 1982.
- CONTROLLING DIMENSION: MILLIMETER.
- DIMENSION A DOES NOT INCLUDE MOLD FLASH, PROTRUSIONS OR GATE BURRS. MOLD FLASH OR GATE BURRS SHALL NOT EXCEED 0.15 (0.006) PER SIDE.
- DIMENSION B DOES NOT INCLUDE INTERLEAD FLASH OR PROTRUSION. INTERLEAD FLASH OR PROTRUSION SHALL NOT EXCEED 0.25 (0.010) PER SIDE.
- DIMENSION K DOES NOT INCLUDE DAMBAR PROTRUSION. ALLOWABLE DAMBAR PROTRUSION SHALL BE 0.08 (0.003) TOTAL IN EXCESS OF THE K DIMENSION AT MAXIMUM MATERIAL CONDITION.
- TERMINAL NUMBERS ARE SHOWN FOR REFERENCE ONLY.
- DIMENSION A AND B ARE TO BE DETERMINED AT DATUM PLANE -W-.

DIM	MILLIMETERS		INCHES	
	MIN	MAX	MIN	MAX
A	4.90	5.10	0.193	0.200
B	4.30	4.50	0.169	0.177
C	---	1.20	---	0.047
D	0.05	0.15	0.002	0.006
F	0.50	0.75	0.020	0.030
G	0.65 BSC		0.026 BSC	
H	0.50	0.60	0.020	0.024
J	0.09	0.20	0.004	0.008
J1	0.09	0.16	0.004	0.006
K	0.19	0.30	0.007	0.012
K1	0.19	0.25	0.007	0.010
L	6.40 BSC		0.252 BSC	
M	0°	8°	0°	8°

GENERIC MARKING DIAGRAM*

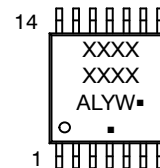

- A = Assembly Location
- L = Wafer Lot
- Y = Year
- W = Work Week
- = Pb-Free Package

(Note: Microdot may be in either location)

*This information is generic. Please refer to device data sheet for actual part marking. Pb-Free indicator, "G" or microdot "▪", may or may not be present. Some products may not follow the Generic Marking.

SOLDERING FOOTPRINT

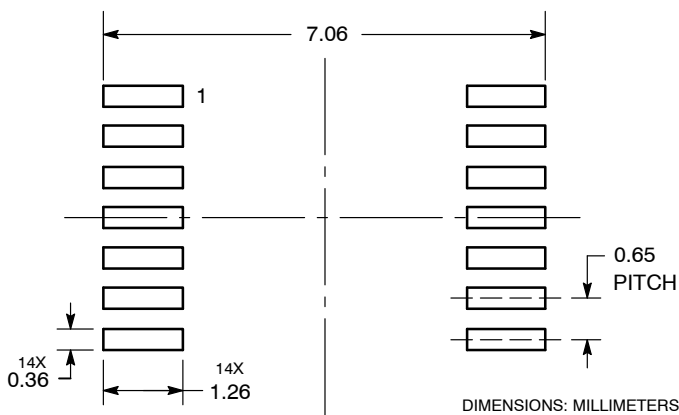

DOCUMENT NUMBER:	98ASH70246A	Electronic versions are uncontrolled except when accessed directly from the Document Repository. Printed versions are uncontrolled except when stamped "CONTROLLED COPY" in red.
DESCRIPTION:	TSSOP-14 WB	PAGE 1 OF 1

onsemi and onsemi are trademarks of Semiconductor Components Industries, LLC dba onsemi or its subsidiaries in the United States and/or other countries. onsemi reserves the right to make changes without further notice to any products herein. onsemi makes no warranty, representation or guarantee regarding the suitability of its products for any particular purpose, nor does onsemi assume any liability arising out of the application or use of any product or circuit, and specifically disclaims any and all liability, including without limitation special, consequential or incidental damages. onsemi does not convey any license under its patent rights nor the rights of others.

onsemi, **Onsemi**, and other names, marks, and brands are registered and/or common law trademarks of Semiconductor Components Industries, LLC dba "**onsemi**" or its affiliates and/or subsidiaries in the United States and/or other countries. **onsemi** owns the rights to a number of patents, trademarks, copyrights, trade secrets, and other intellectual property. A listing of **onsemi**'s product/patent coverage may be accessed at www.onsemi.com/site/pdf/Patent-Marking.pdf. **onsemi** reserves the right to make changes at any time to any products or information herein, without notice. The information herein is provided "as-is" and **onsemi** makes no warranty, representation or guarantee regarding the accuracy of the information, product features, availability, functionality, or suitability of its products for any particular purpose, nor does **onsemi** assume any liability arising out of the application or use of any product or circuit, and specifically disclaims any and all liability, including without limitation special, consequential or incidental damages. Buyer is responsible for its products and applications using **onsemi** products, including compliance with all laws, regulations and safety requirements or standards, regardless of any support or applications information provided by **onsemi**. "Typical" parameters which may be provided in **onsemi** data sheets and/or specifications can and do vary in different applications and actual performance may vary over time. All operating parameters, including "Typicals" must be validated for each customer application by customer's technical experts. **onsemi** does not convey any license under any of its intellectual property rights nor the rights of others. **onsemi** products are not designed, intended, or authorized for use as a critical component in life support systems or any FDA Class 3 medical devices or medical devices with a same or similar classification in a foreign jurisdiction or any devices intended for implantation in the human body. Should Buyer purchase or use **onsemi** products for any such unintended or unauthorized application, Buyer shall indemnify and hold **onsemi** and its officers, employees, subsidiaries, affiliates, and distributors harmless against all claims, costs, damages, and expenses, and reasonable attorney fees arising out of, directly or indirectly, any claim of personal injury or death associated with such unintended or unauthorized use, even if such claim alleges that **onsemi** was negligent regarding the design or manufacture of the part. **onsemi** is an Equal Opportunity/Affirmative Action Employer. This literature is subject to all applicable copyright laws and is not for resale in any manner.

ADDITIONAL INFORMATION

TECHNICAL PUBLICATIONS:

Technical Library: www.onsemi.com/design/resources/technical-documentation
onsemi Website: www.onsemi.com

ONLINE SUPPORT: www.onsemi.com/support

For additional information, please contact your local Sales Representative at www.onsemi.com/support/sales