



## Table of Contents

<b>1 Features</b> .....	1	8.4 Device Functional Modes .....	18
<b>2 Applications</b> .....	1	8.5 Programming .....	18
<b>3 Description</b> .....	1	8.6 Register Maps .....	20
<b>4 Revision History</b> .....	2	<b>9 Applications and Implementation</b> .....	24
<b>5 Description (Continued)</b> .....	3	9.1 Application Information .....	24
<b>6 Pin Configuration and Functions</b> .....	4	9.2 Typical Application .....	24
<b>7 Specifications</b> .....	6	<b>10 Power Supply Recommendations</b> .....	32
7.1 Absolute Maximum Ratings .....	6	<b>11 Layout</b> .....	32
7.2 ESD Ratings .....	6	11.1 Layout Guidelines .....	32
7.3 Recommended Operating Conditions .....	6	11.2 Layout Example .....	33
7.4 Thermal Information .....	7	<b>12 Device and Documentation Support</b> .....	34
7.5 Electrical Characteristics .....	7	12.1 Device Support .....	34
7.6 Timing Requirements .....	9	12.2 Documentation Support .....	34
7.7 Switching Characteristics .....	9	12.3 Related Links .....	34
7.8 Typical Characteristics .....	10	12.4 Trademarks .....	34
<b>8 Detailed Description</b> .....	15	12.5 Electrostatic Discharge Caution .....	34
8.1 Overview .....	15	12.6 Glossary .....	34
8.2 Functional Block Diagram .....	15	<b>13 Mechanical, Packaging, and Orderable Information</b> .....	34
8.3 Feature Description .....	16		

## 4 Revision History

NOTE: Page numbers for previous revisions may differ from page numbers in the current version.

<b>Changes from Revision D (February 2016) to Revision E</b>	<b>Page</b>
• Changed $T_J$ MAX from 125°C to 150°C in <a href="#">Absolute Maximum Ratings</a> .....	6

<b>Changes from Revision C (July 2014) to Revision D</b>	<b>Page</b>
• Deleted SWIFT™ From the datasheet title .....	1
• Moved the Storage Temperature to the <a href="#">Absolute Maximum Ratings</a> .....	6
• Changed <i>Handling Ratings</i> To: <a href="#">ESD Ratings</a> .....	6

<b>Changes from Revision B (March 2014) to Revision C</b>	<b>Page</b>
• Changed <a href="#">Figure 57</a> image for clarification. ....	33

<b>Changes from Revision A (January 2014) to Revision B</b>	<b>Page</b>
• Changed to new data sheet format. ....	1
• Added Device Information table .....	1
• Added Table of Contents and moved Revision History to page 2. ....	2
• Moved Abs Max Ratings, Handling Ratings, Recommended Operating Conditions, Thermal Info, and Elec Characteristics tables to the "Specifications" section .....	6

<b>Changes from Original (November 2013) to Revision A</b>	<b>Page</b>
• Changed data sheet title to include "SWIFT™ Voltage Regulator..." .....	1

## 5 Description (Continued)

The TPS56X20 supports both ultra-low ESR ceramic capacitors and low equivalent series resistance (ESR) output capacitors, such as POSCAP or SP-CAP. The device is optimized for a small 1.0μH to 2.2μH inductor saving PCB area.

The TPS56X20 devices are available in the HTSSOP package.

**List of Devices**

	<b>TPS56520</b>	<b>TPS56720</b>	<b>TPS56920</b>	<b>TPS56C20</b>
Output Current	5A	7A	9A	12A
HS/LS Rdson Numbers	44mΩ/32mΩ	30mΩ/24mΩ	26mΩ/19mΩ	13mΩ/9mΩ
Package	PWP-20	PWP-20	PWP-20	PWP-24

## 6 Pin Configuration and Functions

**TPS56520/720/920**  
**20-Pin PWP Package with PowerPAD**  
**(TOP VIEW)**

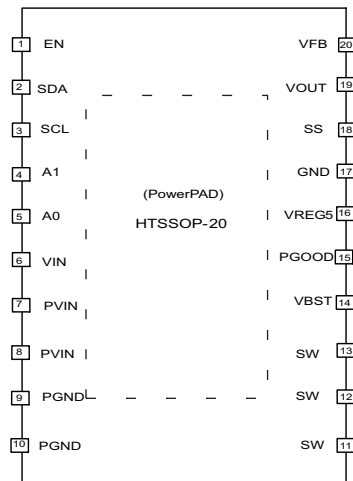

**Pin Functions**

PIN		I/O	DESCRIPTION
NAME	NUMBER		
EN	1	I	Enable. Pull High to enable converter.
SDA	2	I/O	Data I/O terminal.
SCL	3	I/O	Clock I/O terminal.
A1, A0	4,5	I	Chip address.
VIN	6	I	Supply Input for 5.5V linear regulator.
PVIN	7,8	I	Power inputs and connects to high side MOSFET drains.
PGND	9,10	I/O	Ground returns for low-side MOSFETs. Input of current comparator.
SW	11,12,13	I/O	Switch node connections for both the high-side NFETs and low-side NFETs. Input of current comparator.
VBST	14	I	Supply input for high-side NFET gate drive circuit. Connect 0.1µF ceramic capacitor between VBST and SW terminals. An internal diode is connected between VREG5 and VBST.
PGOOD	15	O	Open drain power good output. Low means the output voltage of the corresponding output is out of regulation.
VREG5	16	O	Output of 5.5V linear regulator. Bypass to GND with a high-quality ceramic capacitor of at least 2.0µF ceramic capacitor. Do not connect any other circuitry to the terminal. VREG5 is active when EN is H-level.
GND	17	I/O	Signal GND. Connect sensitive SS and VFB returns to GND at a single point.
SS	18	O	Soft-Start Programming terminal. Connect Capacitor from SS terminal to GND to program Soft-Start time.
VOUT	19	I	Connection to output voltage
VFB	20	I	D-CAP2 feedback input. Connect to output voltage with resistor divider.
Exposed Thermal Pad	Back side	I/O	Thermal pad of the package. Must be soldered to achieve appropriate dissipation. Must be connected to GND.

**TPS56C20**  
**24-Pin PWP Package with PowerPAD**  
**(TOP VIEW)**

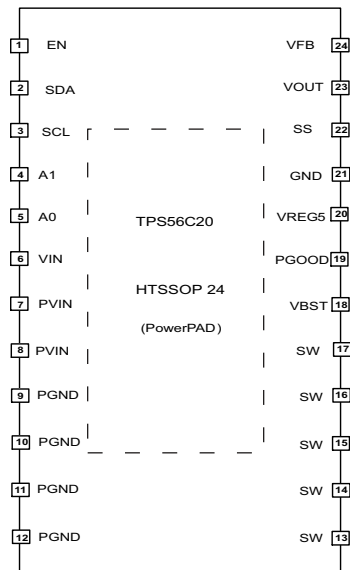

**Pin Functions**

PIN		I/O	DESCRIPTION
NAME	NUMBER		
EN	1	I	Enable. Pull High to enable according converter.
SDA	2	I/O	Data I/O terminal.
SCL	3	I/O	Clock I/O terminal.
A1, A0	4,5	I	Chip address.
VIN	6	I	Supply Input for 5.5V linear regulator.
PVIN	7,8	I	Power inputs and connects to both high side NFET drains.
PGND	9,10,11,12	I/O	Ground returns for low-side MOSFETs. Input of current comparator.
SW	13,14,15,16,17	I/O	Switch node connections for both the high-side NFETs and low-side NFETs. Input of current comparator.
VBST	18	I	Supply input for high-side NFET gate drive circuit. Connect 0.1µF ceramic capacitor between VBST and SW terminals. An internal diode is connected between VREG5 and VBST.
PGOOD	19	O	Open drain power good output. Low means the output voltage of the corresponding output is out of regulation.
VREG5	20	O	Output of 5.5V linear regulator. Bypass to GND with a high-quality ceramic capacitor of at least 3.0µF ceramic capacitor. Do not connect any other circuitry to the terminal. VREG5 is active when EN is H-level.
GND	21	I/O	Signal GND. Connect sensitive SS and VFB returns to GND at a single point.
SS	22	O	Soft-Start Programming terminal. Connect Capacitor from SS terminal to GND to program Soft-Start time.
VOUT	23	I	Connection to output voltage
VFB	24	I	D-CAP2 feedback inputs. Connect to output voltage with resistor divider.
Exposed Thermal Pad	Back side	I/O	Thermal pad of the package. Must be soldered to achieve appropriate dissipation. Must be connected to GND.

## 7 Specifications

### 7.1 Absolute Maximum Ratings

 over operating free-air temperature range (unless otherwise noted) <sup>(1)</sup> <sup>(2)</sup>

		VALUE		UNIT
		MIN	MAX	
Input voltage	VIN, PVIN, EN	-0.3	20	V
	VBST	-0.3	26	
	VBST (10ns transient)	-0.3	28	
	VFB, VOUT, SDA, SCL	-0.3	3.6	
	A0, A1	-0.3	6.5	
	VBST-SW	-0.3	6.5	
	SW	-2	20	
	SW (10ns transient)	-3	22	
Overvoltage	VREG5, SS, PGOOD	-0.3	6.5	V
	PGND	-0.3	0.3	
Sink Current	PGOOD	-0.1	5	mA
T <sub>J</sub>	Operating Junction temperature	-40	150	°C
T <sub>STG</sub>	Storage temperature	-55	150	°C

(1) These are stress ratings only, which do not imply functional operation of the device at these or any other conditions beyond those indicated under Recommended Operating Conditions.

(2) All voltages are with respect to IC GND terminal.

### 7.2 ESD Ratings

		VALUE	UNIT
Electrostatic discharge <sup>(1)</sup>	Human Body Model (HBM) <sup>(2)</sup>	±2000	V
	Charged Device Model (CDM) <sup>(3)</sup>	±500	

(1) Electrostatic discharge (ESD) to measure device sensitivity and immunity to damage caused by assembly line electrostatic discharges into the device.

(2) Level listed above is the passing level per ANSI/ESDA/JEDEC JS-001. JEDEC document JEP155 states that 500-V HBM allows safe manufacturing with a standard ESD control process.

(3) Level listed above is the passing level per EIA-JEDEC JESD22-C101. JEDEC document JEP157 states that 250-V CDM allows safe manufacturing with a standard ESD control process.

### 7.3 Recommended Operating Conditions

over operating free-air temperature range (unless otherwise noted)

		MIN	NOM	MAX	UNIT
VIN	Operating input voltage	4.5		17	V
VOUT	Output voltage	0.6		1.87	V
I <sub>OUT</sub>	Output current	TPS56520		5	A
		TPS56720		7	
		TPS56920		9	
		TPS56C20		12	
T <sub>J</sub>	Operating junction temperature range	-40		125	°C

## 7.4 Thermal Information

THERMAL METRIC <sup>(1)</sup>		TPS56520/720/920	TPS56C20	UNIT
		PWP (20)	PWP (24)	
$\theta_{JA}$	Junction-to-ambient thermal resistance	36.8	32.8	°C/W
$\theta_{JCTop}$	Junction-to-case (top) thermal resistance	22.5	16	
$\theta_{JB}$	Junction-to-board thermal resistance	19.5	14.2	
$\psi_{JT}$	Junction-to-top characterization parameter	0.6	0.4	
$\psi_{JB}$	Junction-to-board characterization parameter	19.2	14	
$\theta_{JCbot}$	Junction-to-case (bottom) thermal resistance	1.4	0.8	

(1) For more information about traditional and new thermal metrics, see the *IC Package Thermal Metrics* application report, [SPRA953](#).

## 7.5 Electrical Characteristics

$T_J = -40^{\circ}\text{C}$  to  $125^{\circ}\text{C}$ ,  $V_{IN}=4.5\text{V}$  to  $17\text{V}$ ,  $PV_{IN}=4.5\text{V}$  to  $17\text{V}$  (Unless otherwise noted)

PARAMETER		CONDITIONS	MIN	TYP	MAX	UNIT
<b>SUPPLY VOLTAGE</b>						
$V_{IN}$	Operating input voltage	$V_{IN}, PV_{IN}$	4.5		17	V
$I_{IN}$	$V_{IN}$ supply current	25°C, EN=5V, VFB=0.8V (non switching), $V_{IN}=12\text{V}$		920	1150	μA
$I_{VNSDN}$	$V_{IN}$ shutdown current	25°C, EN=0V, $V_{IN}=12\text{V}$		140	200	μA
<b>FEEDBACK VOLTAGE</b>						
$V_{VFB}$	VFB voltage	25°C, external regulation mode, $PV_{IN}=12\text{V}$ , $V_{OUT}=1.1\text{V}$ , $I_{OUT}=50\text{mA}$ , pulse skipping	0.594	0.6	0.606	V
		25°C, external regulation mode, $V_{OUT}=1.1\text{V}$ , continuous current mode	0.594	0.6	0.606	V
		External regulation mode, $V_{OUT}=1.1\text{V}$ , continuous current mode	0.591	0.6	0.609	V
<b>VOUT VOLTAGE (INTERNAL VID CONTROL)</b>						
$V_{VOUT}$	VOUT voltage	25°C, relative to target VOUT, $PV_{IN}=12\text{V}$ , $V_{OUT}=0.6\text{V}\sim 1.87\text{V}$ , $L_{OUT}=1.5\mu\text{H}$	-1%	0%	1%	Target VOUT
		Relative to target VOUT, $PV_{IN}=12\text{V}$ , $L_{OUT}=1.5\mu\text{H}$	-1.5%	0%	1.5%	
		Relative to target VOUT, $L_{OUT}=1.5\mu\text{H}$	-2%	0%	2%	
<b>VREG5 OUTPUT</b>						
$V_{VREG5}$	VREG5 Output Voltage	25°C, $6\text{V} < V_{IN} < 17\text{V}$ , $I_{VREG5} = 5\text{mA}$ , VFB=1V	5.2	5.5	5.7	V
<b>MOSFET</b>						
$r_{DS(on)H}$	High side switch resistance TPS56520	VBST-SW=5.5V		44		mΩ
$r_{DS(on)L}$	Low side switch resistance TPS56520	$V_{IN}=12\text{V}$		32		mΩ
$r_{DS(on)H}$	High side switch resistance TPS56720	VBST-SW=5.5V		30		mΩ
$r_{DS(on)L}$	Low side switch resistance TPS56720	$V_{IN}=12\text{V}$		24		mΩ
$r_{DS(on)H}$	High side switch resistance TPS56920	VBST-SW=5.5V		26		mΩ
$r_{DS(on)L}$	Low side switch resistance TPS56920	$V_{IN}=12\text{V}$		19		mΩ
$r_{DS(on)H}$	High side switch resistance TPS56C20	VBST-SW=5.5V		13		mΩ
$r_{DS(on)L}$	Low side switch resistance TPS56C20	$V_{IN}=12\text{V}$		9		mΩ
<b>POWER GOOD</b>						
$V_{PGOODTH}$	PGOOD threshold	VOUT or VFB falling (fault) $VO=1.1\text{V}$		80%		
		VOUT or VFB rising (good) $VO=1.1\text{V}$		85%		
		VOUT or VFB rising (fault) $VO=1.1\text{V}$		115%		
		VOUT or VFB falling (good) $VO=1.1\text{V}$		110%		
$I_{PGOODLY}$	PGOOD sink current	VPGOOD=0.5V	3.15	5.2		mA

**Electrical Characteristics (continued)**
 $T_J = -40^{\circ}\text{C}$  to  $125^{\circ}\text{C}$ ,  $V_{IN}=4.5\text{V}$  to  $17\text{V}$ ,  $P_{VIN}=4.5\text{V}$  to  $17\text{V}$  (Unless otherwise noted)

PARAMETER		CONDITIONS	MIN	TYP	MAX	UNIT
<b>LOGIC THRESHOLD</b>						
$V_{ENH}$	EN H-level threshold voltage		1.85			V
$V_{ENL}$	EN L-level threshold voltage				0.6	V
<b>CURRENT LIMIT<sup>(1)</sup></b>						
$I_{OCL}$	Current Limit TPS56520	LOUT= 1.5 $\mu$ H	5.6	9		A
	Current Limit TPS56720	LOUT= 1.5 $\mu$ H	7.8	12		A
	Current Limit TPS56920	LOUT= 1.5 $\mu$ H	10	15		A
	Current Limit TPS56C20	LOUT= 1.5 $\mu$ H	13.2	20		A
$I_{OCLR}$	Reverse Current Limit TPS56520	LOUT= 1.5 $\mu$ H	1.25	5.3		A
	Reverse Current Limit TPS56720	LOUT= 1.5 $\mu$ H	1.75	6.5		A
	Reverse Current Limit TPS56920	LOUT= 1.5 $\mu$ H	2.25	6.2		A
	Reverse Current Limit TPS56C20	LOUT= 1.5 $\mu$ H	3	8.2		A
<b>OUTPUT UNDERVOLTAGE PROTECTION (UVP)</b>						
$V_{OVP}$	Output OVP trip threshold	OVP detect (L>H)		125%		VOUT
$V_{UVP}$	Output UVP trip threshold	UVP detect (H>L)		60%		VOUT
<b>THERMAL SHUTDOWN</b>						
$T_{SDN}$	Thermal shutdown Threshold	Shutdown temperature <sup>(1)</sup>		160		$^{\circ}\text{C}$
		Hysteresis <sup>(1)</sup>		23		$^{\circ}\text{C}$
		Pre-thermal warning threshold		130		$^{\circ}\text{C}$
<b>UVLO</b>						
UVLO	UVLO Threshold	Wake up to VREG5 voltage	3.45	3.9	4.2	V
		Hysteresis VREG5 voltage	0.45	0.56	0.61	V

(1) Ensured by design. Not production tested.



## 7.6 Timing Requirements

			MIN	TYP	MAX	UNIT
<b>SOFT START</b>						
I <sub>SSC</sub>	SS charge current	V <sub>SS</sub> =0.5V , 25 °C	-6.4	-6	-5.6	μA
I <sub>SSD</sub>	SS discharge current	V <sub>SS</sub> =0.5V	0.14	0.2	0.26	mA
<b>SERIAL INTERFACE</b> <sup>(1) (2) (3)</sup>						
V <sub>IL</sub>	LOW level input voltage				0.6	V
V <sub>IH</sub>	HIGH level input voltage		1.8			V
V <sub>hys</sub>	Hysteresis of Schmitt trigger inputs		0.11			V
V <sub>OL</sub>	LOW level output voltage (Open drain, 3mA sink current)				0.4	V
t <sub>SP</sub>	Pulse width of spikes suppressed by input filter		32			ns
f <sub>scl</sub>	SCL clock frequency				400	kHz
t <sub>HD,STA</sub>	Hold time (repeated) START condition.		0.6			us
t <sub>LOW</sub>	LOW period of SCL clock		1.3			us
t <sub>HIGH</sub>	HIGH period of SCL clock		0.6			us
t <sub>SU,STA</sub>	Set-up time for a repeated START condition		0.6			us
t <sub>HD,DAT</sub>	Data Hold time		50		900	ns
t <sub>SU,DAT</sub>	Data set-up time		100			ns
t <sub>r</sub>	Rise time (SDA or SCL)		20+0.1Cb(4)		300	ns
t <sub>f</sub>	Fall time (SDA or SCL)		20+0.1Cb(4)		300	ns
t <sub>SU,STO</sub>	Set-up time for STOP condition		0.6			us
t <sub>BUF</sub>	Bus free time between STOP and START condition		1.3			us
C <sub>b</sub>	Capacitive load for each bus line				400	pF

- (1) Ensured by design. Not production tested.  
(2) Refer to Figure 1 below for I<sup>2</sup>C Timing Definitions  
(3) C<sub>b</sub> = capacitance of bus line in pF

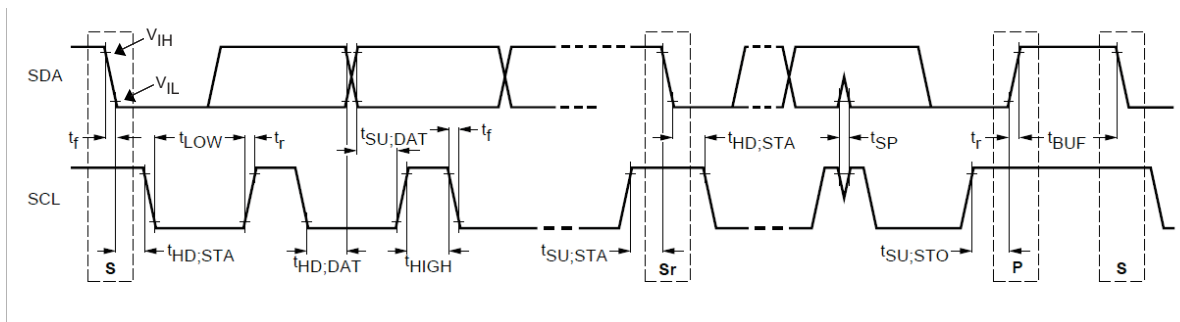

Figure 1. I<sup>2</sup>C Timing Definitions (reproduced from Phillips I<sup>2</sup>C spec Version 1.1)

## 7.7 Switching Characteristics

over operating free-air temperature range (unless otherwise noted)

PARAMETER	TEST CONDITIONS	MIN	TYP	MAX	UNIT
<b>ON-TIME TIMER CONTROL</b>					
T <sub>ON</sub>	SW On Time	SW=12V, VOUT=1.1V		180	ns
T <sub>OFF</sub> <sup>(1)</sup>	SW Minimum off time	25°C, VFB= 0.5V		285	ns

- (1) Ensured by design. Not production tested.

## 7.8 Typical Characteristics

$V_{IN} = 12\text{ V}$ ,  $V_{OUT} = 1.0\text{ V}$ ,  $T_a = 25\text{ }^\circ\text{C}$ , unless otherwise specified.

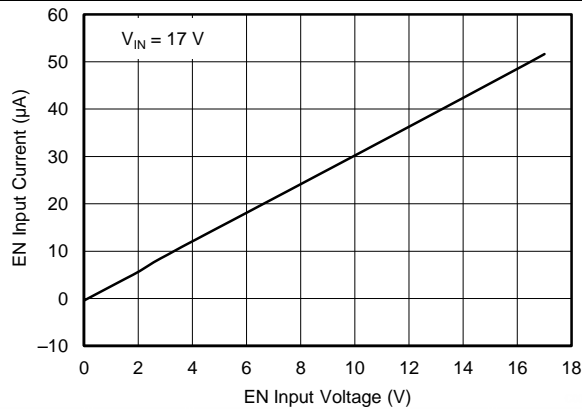

Figure 2. TPS56X20 Enable Input Current

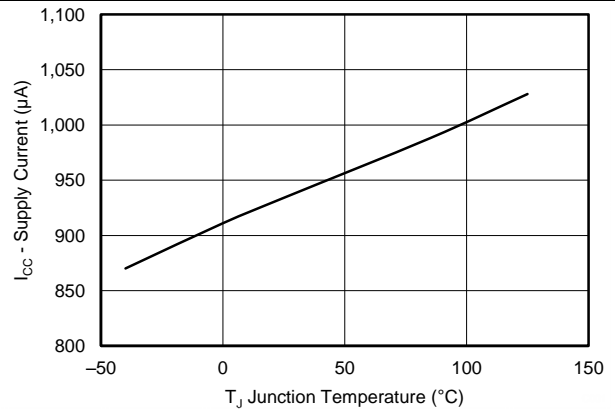

Figure 3. TPS56520 Quiescent Current

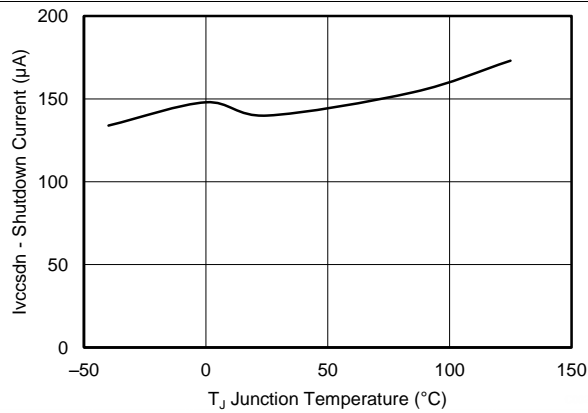

Figure 4. TPS56520 Shutdown Quiescent Current

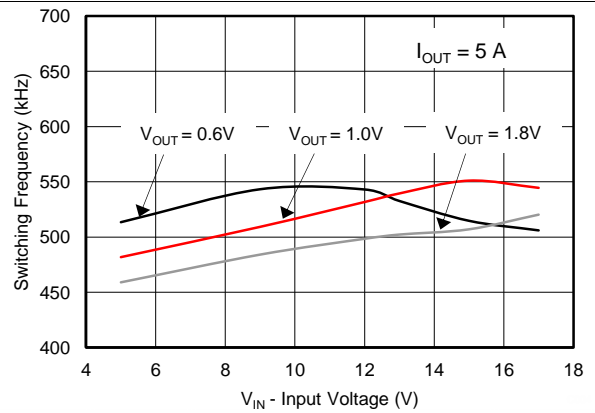

Figure 5. TPS56520 Switching Frequency

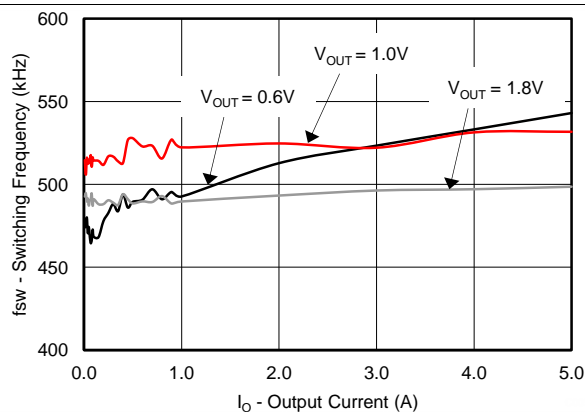

Figure 6. TPS56520 Switching Frequency, Eco-mode™ = OFF

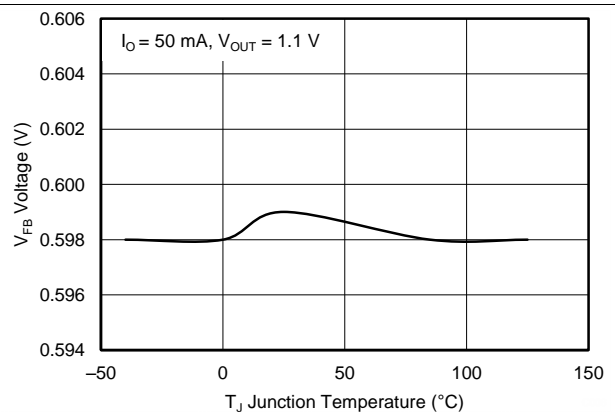

Figure 7. TPS56520 Feedback Voltage

Typical Characteristics (continued)

$V_{IN} = 12\text{ V}$ ,  $V_{OUT} = 1.0\text{ V}$ ,  $T_a = 25\text{ }^\circ\text{C}$ , unless otherwise specified.

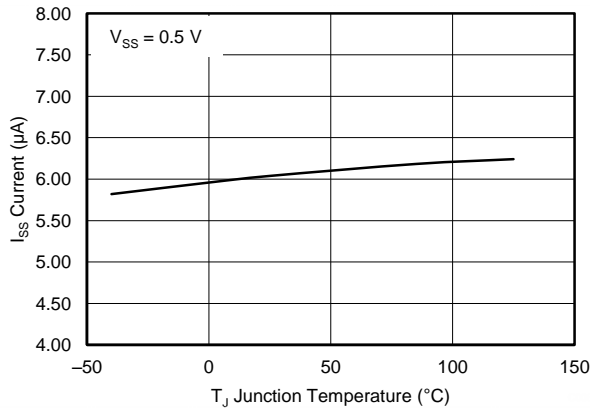

Figure 8. TPS56520 Soft Start Charging Current

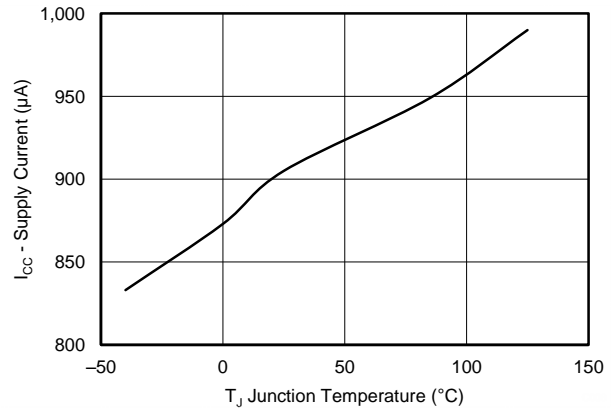

Figure 9. TPS56720 Quiescent Current

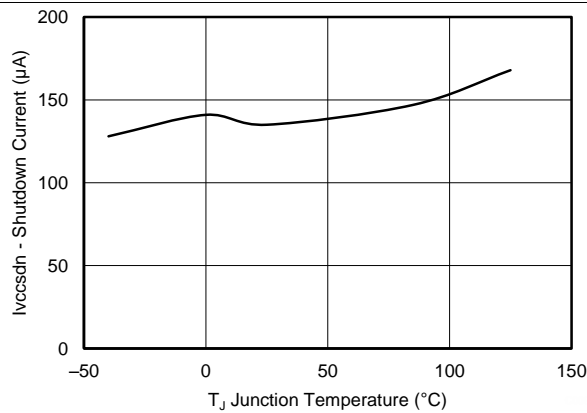

Figure 10. TPS56720 Shutdown Quiescent Current

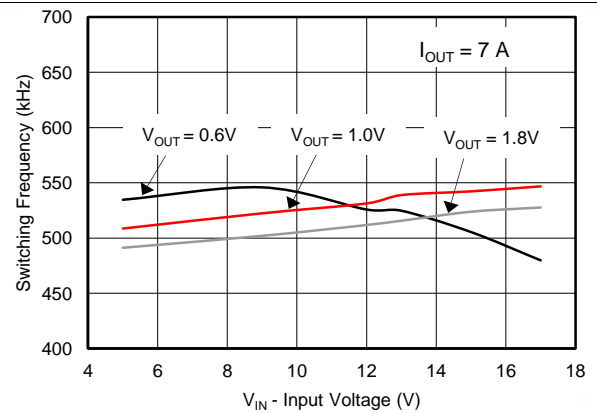

Figure 11. TPS56720 Switching Frequency

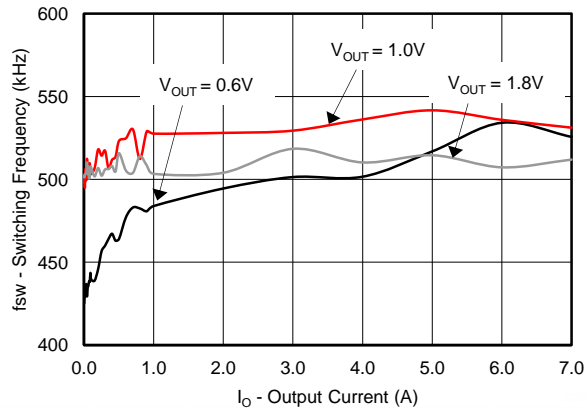

Figure 12. TPS56720 Switching Frequency, Eco-mode™ = OFF

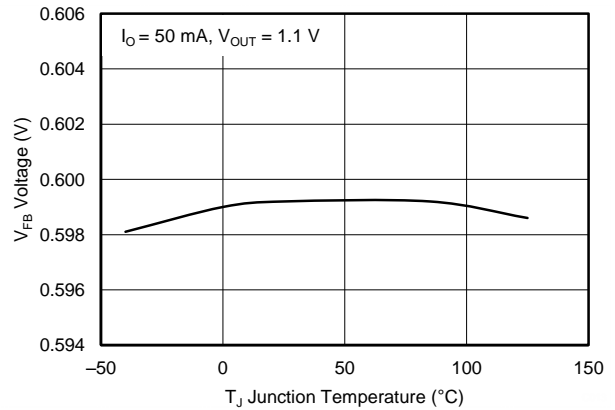

Figure 13. TPS56720 Feedback Voltage

### Typical Characteristics (continued)

$V_{IN} = 12\text{ V}$ ,  $V_{OUT} = 1.0\text{ V}$ ,  $T_a = 25\text{ }^\circ\text{C}$ , unless otherwise specified.

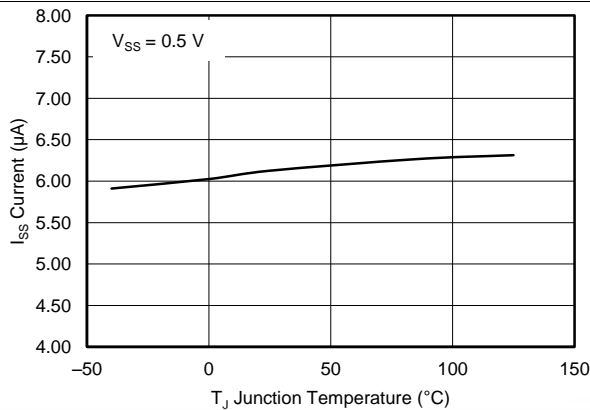

Figure 14. TPS56720 Soft Start Charging Current

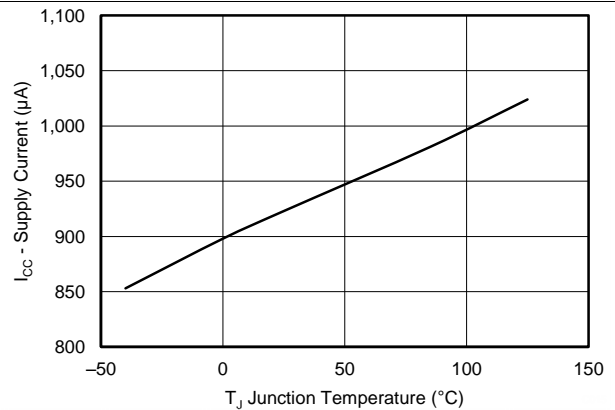

Figure 15. TPS56920 Quiescent Current

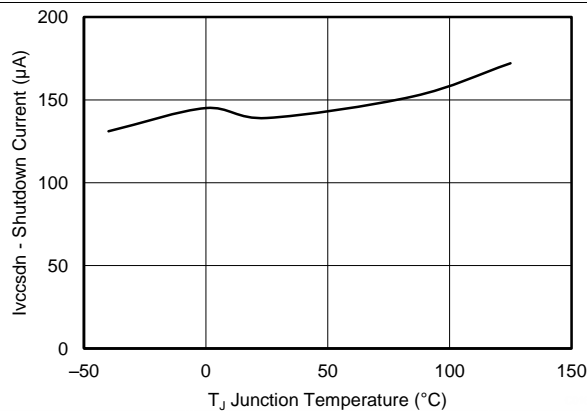

Figure 16. TPS56920 Shutdown Quiescent Current

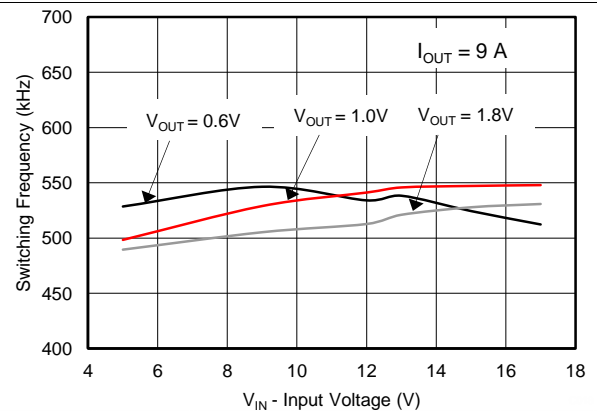

Figure 17. TPS56920 Switching Frequency

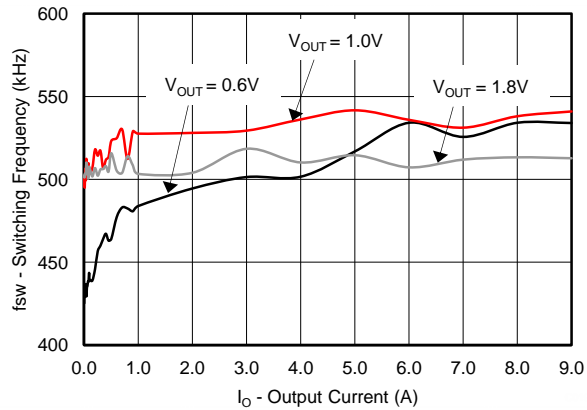

Figure 18. TPS56920 Switching Frequency, Eco-mode™ = OFF

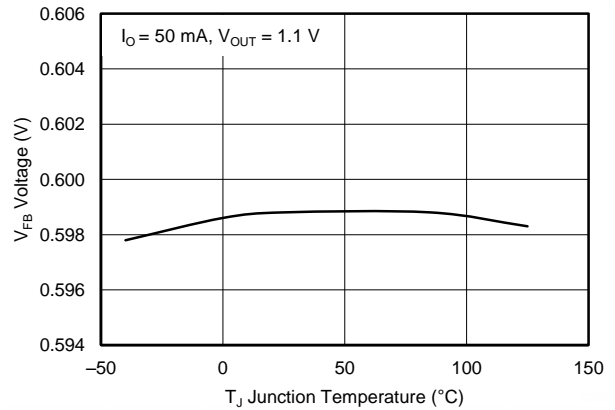

Figure 19. TPS56920 Feedback Voltage

Typical Characteristics (continued)

$V_{IN} = 12\text{ V}$ ,  $V_{OUT} = 1.0\text{ V}$ ,  $T_a = 25\text{ }^\circ\text{C}$ , unless otherwise specified.

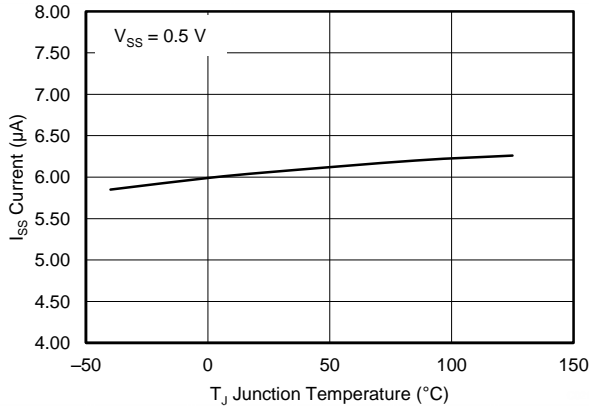

Figure 20. TPS56920 Soft Start Charging Current

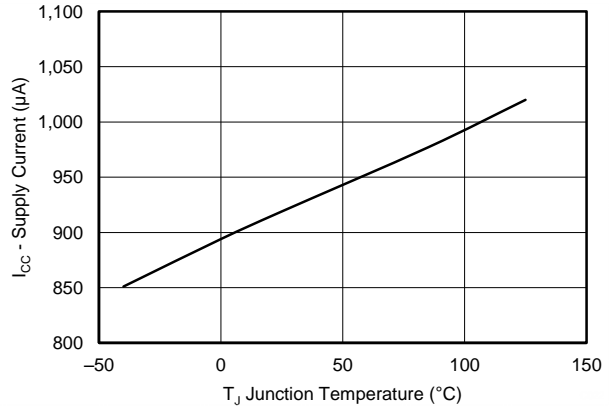

Figure 21. TPS56C20 Quiescent Current

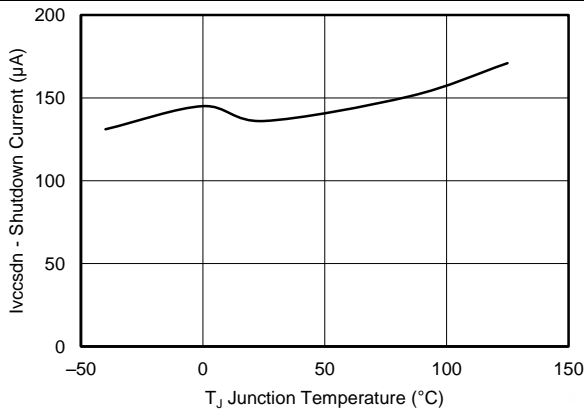

Figure 22. TPS56C20 Shutdown Quiescent Current

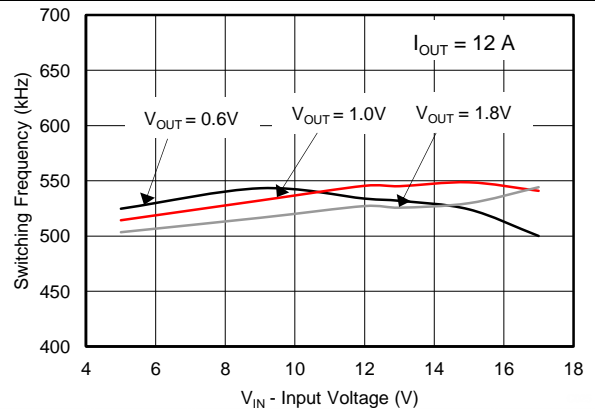

Figure 23. TPS56C20 Switching Frequency

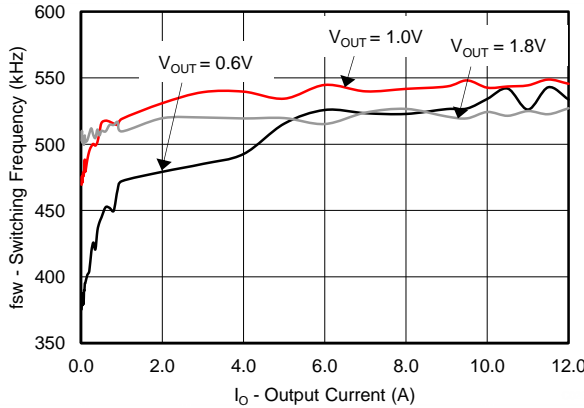

Figure 24. TPS56C20 Switching Frequency, Eco-mode™ = OFF

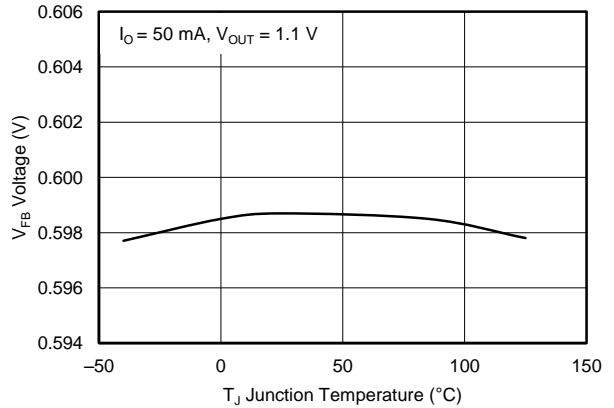
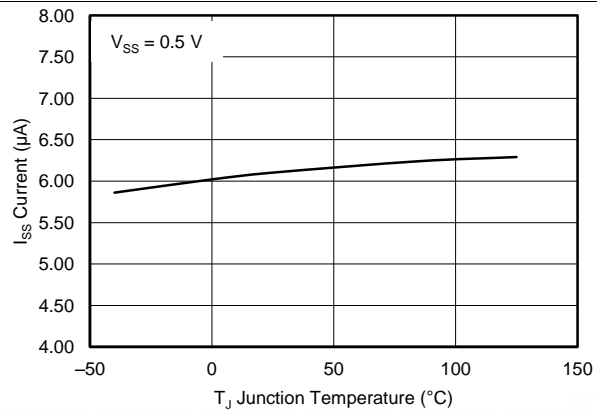

Figure 25. TPS56C20 Feedback Voltage

**Typical Characteristics (continued)**
 $V_{IN} = 12\text{ V}$ ,  $V_{OUT} = 1.0\text{ V}$ ,  $T_a = 25\text{ }^\circ\text{C}$ , unless otherwise specified.

**Figure 26. TPS56C20 Soft Start Charging Current**

## 8 Detailed Description

### 8.1 Overview

The TPS56X20 is a synchronous step-down (buck) converter with two integrated N-channel MOSFETs for each channel. It operates using D-CAP2™ control mode. The fast transient response of D-CAP2™ control reduces the required output capacitance required to meet a specific level of performance. The output voltage of the TPS56X20 can be set by either VFB with divider resistors (Adjusting the Output Voltage by External Regulation Mode) or I2C compatible interface (Programming the Output Voltage by Internal Regulation Mode).

When only external regulation mode is used in a TPS56X20 application, the VOUT terminal should be tied to the output voltage of the converter and SDA & SCL terminals should be grounded. A0 & A1 terminals may be floating.

When only internal regulation mode is used in a TPS56X20 application, the VFB terminal should be connected to the output voltage of the converter.

The integrated MOSFETs allow for high efficiency power supply designs. The MOSFETs have been sized to optimize efficiency for lower duty cycle applications.

### 8.2 Functional Block Diagram

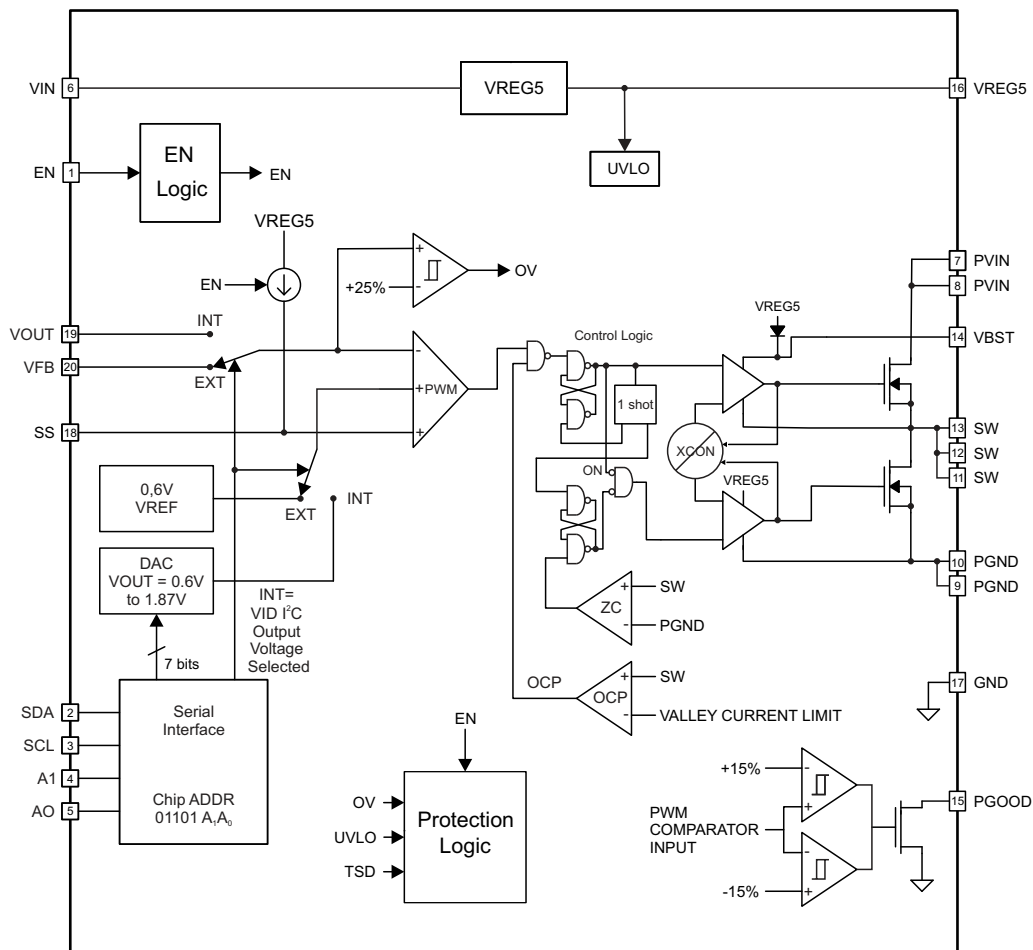
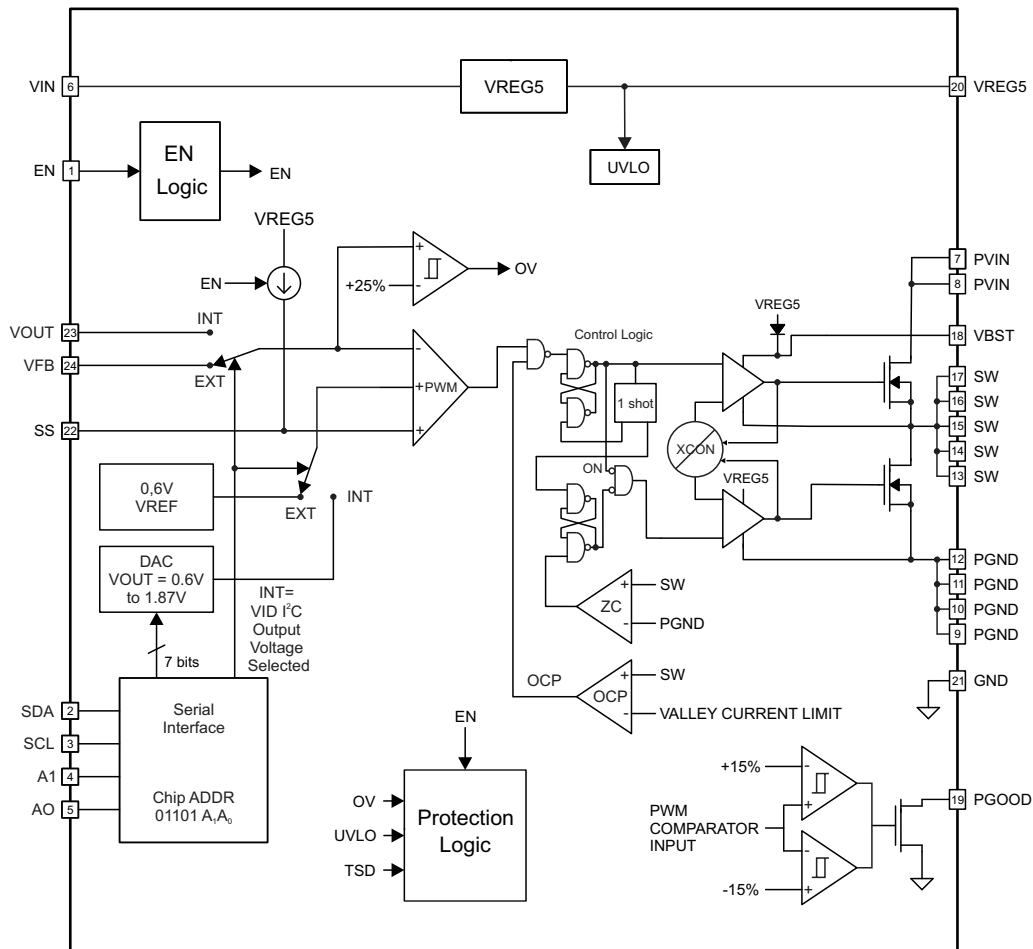

Figure 27. TPS56520, TPS56720 and TPS56920 20 Terminal

**Functional Block Diagram (continued)**

**Figure 28. TPS56C20 24 Terminal**

## 8.3 Feature Description

### 8.3.1 PWM Operation

The main control loop of the TPS56X20 is an adaptive on-time pulse width modulation (PWM) controller that supports a proprietary D-CAP2™ mode control. D-CAP2™ control combines constant on-time control with an internal compensation circuit for pseudo-fixed frequency and low external component count configuration with both low ESR and ceramic output capacitors. It is stable even with virtually no ripple at the output.

At the beginning of each cycle, the high-side MOSFET is turned on. This MOSFET is turned off when the internal timer expires. This timer is set by the converter's input voltage,  $V_{IN}$ , and the output voltage,  $V_{OUT}$ , to maintain a pseudo-fixed frequency over the input voltage range hence it is called adaptive on-time control. The timer is reset and the high-side MOSFET is turned on again when the feedback voltage falls below the nominal output voltage. An internal ramp is added to the reference voltage to simulate output voltage ripple, eliminating the need for ESR induced output ripple from D-CAP2™ mode control.

### 8.3.2 PWM Frequency and Adaptive On-Time Control

TPS56X20 uses an adaptive on-time control scheme and does not have a dedicated on board oscillator. The TPS56X20 runs with a pseudo-constant frequency of 500 kHz by using the input voltage and output voltage to set the on-time timer. The on-time is inversely proportional to the input voltage and proportional to the output voltage, therefore, when the duty ratio is  $V_O/P_{VIN}$ , the frequency is constant.



## Feature Description (continued)

### 8.3.3 VIN and Power VIN Terminals (VIN and PVIN)

The device allows for a variety of applications by using the VIN and PVIN terminals together or separately. The VIN terminal voltage supplies the internal control circuits of the device. The PVIN terminal voltage provides the input voltage to the power converter system. The input voltage for VIN and PVIN can range from 4.5V to 17V.

### 8.3.4 Auto-Skip Eco-mode™ Control

The TPS56X20 is designed with Auto-Skip Eco-mode™ to increase light load efficiency.

### 8.3.5 Soft Start and Pre-Biased Soft Start

The soft start function is adjustable. When the EN terminal becomes high, 6-μA current begins charging the capacitor which is connected from the SS terminal to GND. Smooth control of the output voltage is maintained during start up. The equation for the slow start time is shown in [Equation 1](#). VFB voltage is 0.6 V and SS terminal source current is 6μA.

$$T_{ss}(ms) = \frac{C_{SS}(nF) \times VFB(V)}{I_{SSC}(\mu A)} \quad (1)$$

The TPS56X20 contains a unique circuit to prevent current from being pulled from the output during startup if the output is pre-biased. When the soft-start commands a voltage higher than the pre-bias level (internal soft start becomes greater than internal feedback voltage, VFB), the controller slowly activates synchronous rectification by starting the first low side FET gate driver pulses with a narrow on-time. It then increments that on-time on a cycle-by-cycle basis until it coincides with the time dictated by (1-D), where D is the duty cycle of the converter. This scheme prevents the initial sinking of the pre-biased output, and ensures that the output voltage (VOUT) starts and ramps up smoothly into regulation from pre-biased startup to normal mode operation. When pre-biased conditions exist, it is recommended to disable the device by pulling the EN terminal to ground.

### 8.3.6 Power Good

The power-good function is activated after soft start has finished. The PGOOD output is an open drain output. When the output voltage is between 85% and 110% of the target value, internal comparator detect power good state and the power good signal becomes high. If the output voltage is lower than 80% or greater than 115% of the target value, the power good signal becomes low.

### 8.3.7 Overcurrent Protection

The output overcurrent protection (OCP) is implemented using a cycle-by-cycle valley detect control circuit. The switch current is monitored by measuring the low-side FET switch voltage between the SW terminal and GND. This voltage is proportional to the switch current. To improve accuracy, the voltage sensing is temperature compensated.

During the on time of the high-side FET switch, the switch current increases at a linear rate determined by VIN, VOUT, the on-time and the output inductor value. During the on time of the low-side FET switch, this current decreases linearly. The average value of the switch current is the load current I<sub>out</sub>. The TPS56X20 constantly monitors the low-side FET switch voltage, which is proportional to the switch current, during the low-side on-time. If the measured voltage is above the voltage proportional to the current limit, an internal counter is incremented per each switching cycle and the converter maintains the low-side switch on until the measured voltage is below the voltage corresponding to the current limit at which time the switching cycle is terminated and a new switching cycle begins. In subsequent switching cycles, the on-time is set to a fixed value and the current is monitored in the same manner.

There are some important considerations for this type of overcurrent protection. The peak current is the average load current plus one half of the peak-to-peak inductor current. The valley current is the average load current minus one half of the peak-to-peak inductor current. Since the valley current is used to detect the overcurrent threshold, the load current is higher than the overcurrent threshold. Also, when the current is being limited, the output voltage tends to fall as the demanded load current may be higher than the current available from the converter. When the output voltage becomes lower than 60% of the target voltage, the UVP comparator detects it. Depending on the values of Hiccup Mode bit and UVP Latchoff Mode bit in the Control A and Control B registers, the device may enter Hiccup Mode or Latchoff Mode or keep running under cycle-by-cycle current limiting.

## Feature Description (continued)

The TPS56X20 also implements reverse overcurrent protection. When reverse overcurrent protection is triggered, the high-side MOSFET turns on for the preset on-time and then the low-side MOSFET turns on to monitor the switch valley current. The high-side MOSFET turns on again if either VFB pin voltage drops below reference voltage, or the reverse switch current hits the reverse current trip point.

### 8.3.8 UVLO Protection

Under-voltage lock out protection (UVLO) monitors the voltage of the VREG5 terminal. When the VREG5 voltage is lower than UVLO threshold voltage, the TPS56X20 is shut off. This protection is non-latching.

## 8.4 Device Functional Modes

### 8.4.1 Operation at Light Loads

The TPS56x20 works in Auto-Skip Eco-mode™ at light load to boost the efficiency. As the output current decreases from heavy load condition, the inductor current is also reduced and eventually comes to the where its ripple valley touches the zero level, which is the boundary between continuous conduction and discontinuous conduction modes. The rectifying MOSFET is turned off when its zero inductor current is detected. As the load current further decreases the converter run into discontinuous conduction mode. The on-time is kept same as it was in the continuous conduction mode because it takes longer to discharge the output capacitor with smaller load current to the level of the nominal output voltage. The transition point to the light load operation  $I_{O(LL)}$  current can be estimated with Equation 2 with 500kHz used as  $f_{sw}$ .

$$I_{OUT(LL)} = \frac{1}{2 \times L_O \times f_{SW}} \times \frac{(P_{VIN} - V_{OUT}) \times V_{OUT}}{P_{VIN}} \quad (2)$$

## 8.5 Programming

### 8.5.1 I<sup>2</sup>C Interface

The TPS56X20 implements a subset of the Phillips I<sup>2</sup>C specification Ver. 1.1. The TPS56X20 is a Slave-Only (it never becomes a Master, and so never pulls down the **SCL** terminal on the I<sup>2</sup>C bus). An I<sup>2</sup>C transaction consists of either writing a data byte to one of the TPS56X20's internal registers which requires a 3-byte transaction or reading back one byte from a register which requires a 4-byte transaction. The protocols follow the System Management Bus (SMBUS) Specification Ver. 2.0 *Write Byte and Read Byte* protocols. This spec is available on the Internet for further reading, but the subset implemented in TPS56X20 is described below.

Long-form address modes, multi-byte data transfers and Packet Error Code (PEC) protocols are not supported in this implementation, though a Check Sum bit unique to the TPS56X20 is implemented and described below. **The SMBUS Send Byte protocol (the 2-byte protocol used in TPS56921) is not implemented on TPS56X20.**

The I<sup>2</sup>C interface terminals are composed of the **SDA** (Data) and **SCL** (Clock) terminals, and the **A0** and **A1** terminals to set up the chip's address. **SDA** and **SCL** are designed to be used with pullup resistors to 3.3V. **A0** and **A1** are designed to be either grounded (logic LOW) or left open (logic HIGH) and should not tie to a high voltage.

### 8.5.2 I<sup>2</sup>C Protocol

*Input voltage* – Logic levels for I<sup>2</sup>C **SDA** and **SCL** terminals are not fixed. For the TPS56X20, a logic "0" (LOW) should be 0V and a logic "1" (HIGH) can be any voltage between 1.8V and 3.3V. Logic HIGH is generated by external pullup resistors (see next paragraph).

*Output voltage* – the I<sup>2</sup>C bus has external pullup resistors, one for SCL and one for SDA. These pull up to a voltage called VDD which must lie between 1.8V and 3.3V. The outputs are pulled down to their logic LOW levels by open-drain outputs and pulled up to their logic HIGH levels by these external pullups. The pullups must be selected so that the current into any chip when pulled LOW by that chip's open drain output (=VDD/RPULLUP) is less than 3.3mA.

*Data format* – One clock pulse on the **SCL** clock line is generated for each bit of data to be transferred. The data on the **SDA** line must be stable during the HIGH period of the **SCL** clock line. The HIGH or LOW state of the data line can only change when the clock signal on the **SCL** line is LOW.

**Programming (continued)**

**START and STOP conditions** – A HIGH to LOW transition on the **SDA** line while the **SCL** line is HIGH defines a START condition. A LOW to HIGH transition on the **SDA** line while the **SCL** line is HIGH defines a STOP condition. START and STOP conditions are always generated by the Master. The bus is considered to be BUSY after the condition. It is considered to be free again after a minimum of 4.7µS after the STOP condition.

The bus stays busy if a repeated START (Sr) is generated instead of a STOP condition. START and repeated START are functionally identical.

Every byte of data out on the **SDA** line is 8 bits long. 9 clocks occur for each byte (the additional clock being for an ACK signal put onto the bus by the TPS56X20 pulling down on the bus to acknowledge receipt of the data). In the following diagrams, shaded blocks indicate **SDA** data generated by the TPS56X20 being sent to the Master I<sup>2</sup>C controller, while white blocks indicate **SDA** data generated by the Master being received by the TPS56X20. The Master always generates the **SCL** signal.

Sending data to the TPS56X20 is accomplished using the following 3-byte sequence, referred to as a *Write Byte* transaction as follows:

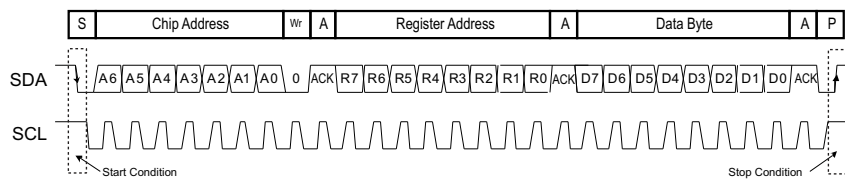

**Figure 29. A complete Write Byte transfer, adapted from SMBUS spec**

Reading back data from the TPS56X20 is accomplished using the following 4-byte sequence, referred to as a *Read Byte* transaction:

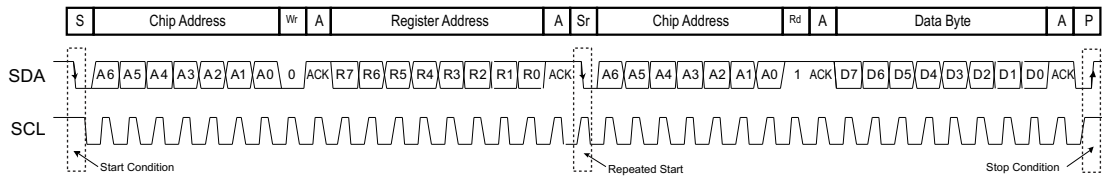

**Figure 30. A complete Read Byte transfer, adapted from SMBUS spec**

On the TPS56X20, the I2C bus is inactive until:

1. Both SDA and SCL have been at a logic high simultaneously to prevent power sequencing issues
2. VREG5 is in regulation.

Control registers should not be written to during the Soft Start time, but can be written before VOUT is enabled or after the **PGOOD** terminal or status register go high, indicating that soft start is complete.

Until a VOUT command has been accepted, the TPS56X20's output voltage will be determined by the external resistor divider feedback to the **VFB** terminals, the condition of the **EN** terminals, and the capacitance on the **SS** terminals.

When the TPS56X20 receives a Chip Address code it recognizes to be its own, it will respond by sending an ACK (pulling down on the **SDA** bus during the next clock on the **SCL** bus). If the address is not recognized, the TPS56X20 assumes that the I<sup>2</sup>C message is intended for another chip on the bus, and it takes no action. It will disregard data sent thereafter until the next START is begun.

If, after recognizing its Chip Address, the TPS56X20 receives a valid Register Address, it will send an ACK and prepare to receive a Data Byte to be sent to that Register.

If a valid Data Byte is then received, it will send an ACK and will set the output voltage to the desired value. If the byte is deemed invalid, ACK will not be sent and the Master will need to retry by sending a STOP sequence followed by a new START sequence and an initiating resend of the entire address/data packet. When sending data to the Output Voltage register, the output voltage will only change upon receipt of a valid data byte.

## Programming (continued)

### 8.5.3 I<sup>2</sup>C Chip Address Byte

The 7-bit address of the TPS56X20 can be any number between 34h (0110100) and 37h (0110111). The 5 MSB's are set internally and the 2 LSB's are customer-selectable via the **A1** and **A0** terminals, allowing up to 4 TPS56X20's to be controlled on the same I2C bus. When the Master is sending the address as an 8-bit value, the 7-bit address should be sent followed by a trailing 0 to indicate this is a WRITE operation. A0 and A1 must be floated for logic 1. Do not tie them to external voltage source. The following codes assume this trailing zero.

**Table 1. TPS56X20 Address as a Function of A1 and A0 Terminals**

A1	A0	Address (binary)	Address (hex)
Ground (0)	Ground (0)	01101000	68h
Ground (0)	Open (1)	01101010	6Ah
Open (1)	Ground (0)	01101100	6Ch
Open (1)	Open (1)	01101110	6Eh

## 8.6 Register Maps

### 8.6.1 I<sup>2</sup>C Register Address Byte

The TPS56X20 contains four customer-accessible registers. Register 0 is the Output Voltage register. Registers 8 and 9 set several operating features for the regulator. The lower 3 bits of Register 9 sets the current limit for the high-current, etc. Register 24 provides the status of the regulator. The register map is as follows:

Register Name	Addr (Decimal)	Bit 7	Bit 6	Bit 5	Bit 4	Bit 3	Bit 2	Bit 1	Bit 0
VOUT	0	Odd Parity	VOUT[6:0]						
Control A	8	Internal Mode	PGOOD Delay [1:0]		Hiccup Mode On	—	ECO Mode On	DAC Settle [1:0]	
Control B	9	Enable	—	OVP Latchoff Mode Off	UVP Latchoff Mode Off	—	Current Limit [2:0]		
Status (Read Only)	24	—	TI Only	TI Only	TI Only	TI Only	OT Shut Down	Early OT Warn	PGOOD

### 8.6.2 Output Voltage Registers

The lower 7 bits of the Output Voltage Register controls the VOUT of the TPS56X20. These bits are the 7-bit selector for one of the output voltages.

As previously mentioned, when the IC powers up, the startup and output voltage regulation conditions are set by the external resistor divider feedback to the **VFB** terminal, the condition of the **EN** terminal, and the capacitance on the **SS** terminal.

Bringing the **EN** terminal high (or setting the Enable bit in Control register 9 high) begins a soft-start ramp on the regulator.

After applying VIN, VREG5 will come into regulation and the I2C interface will active. The user can activate soft start and VOUT by bring the **EN** terminal high or programming the Enable bit in Control Register 9.

By default, the part will regulate VOUT using the external feedback resistors connected to the **VFB** terminal. The user can then program VOUT by writing any VOUT code. Alternatively, if the **EN** terminal is low, soft start and VOUT can be enabled by writing the desired VOUT code and programming the Enable bit to a one.

**Table 2. Ideal VOUT vs VOUT[6:0] Code**

Code	Binary	VOUT	Code	Binary	VOUT	Code	Binary	VOUT	Code	Binary	VOUT
0	0000000	0.60	32	0100000	0.92	64	1000000	1.24	96	1100000	1.56
1	0000001	0.61	33	0100001	0.93	65	1000001	1.25	97	1100001	1.57
2	0000010	0.62	34	0100010	0.94	66	1000010	1.26	98	1100010	1.58
3	0000011	0.63	35	0100011	0.95	67	1000011	1.27	99	1100011	1.59
4	0000100	0.64	36	0100100	0.96	68	1000100	1.28	100	1100100	1.60
5	0000101	0.65	37	0100101	0.97	69	1000101	1.29	101	1100101	1.61
6	0000110	0.66	38	0100110	0.98	70	1000110	1.30	102	1100110	1.62
7	0000111	0.67	39	0100111	0.99	71	1000111	1.31	103	1100111	1.63
8	0001000	0.68	40	0101000	1.00	72	1001000	1.32	104	1101000	1.64
9	0001001	0.69	41	0101001	1.01	73	1001001	1.33	105	1101001	1.65
10	0001010	0.70	42	0101010	1.02	74	1001010	1.34	106	1101010	1.66
11	0001011	0.71	43	0101011	1.03	75	1001011	1.35	107	1101011	1.67
12	0001100	0.72	44	0101100	1.04	76	1001100	1.36	108	1101100	1.68
13	0001101	0.73	45	0101101	1.05	77	1001101	1.37	109	1101101	1.69
14	0001110	0.74	46	0101110	1.06	78	1001110	1.38	110	1101110	1.70
15	0001111	0.75	47	0101111	1.07	79	1001111	1.39	111	1101111	1.71
16	0010000	0.76	48	0110000	1.08	80	1010000	1.40	112	1110000	1.72
17	0010001	0.77	49	0110001	1.09	81	1010001	1.41	113	1110001	1.73
18	0010010	0.78	50	0110010	1.10	82	1010010	1.42	114	1110010	1.74
19	0010011	0.79	51	0110011	1.11	83	1010011	1.43	115	1110011	1.75
20	0010100	0.80	52	0110100	1.12	84	1010100	1.44	116	1110100	1.76
21	0010101	0.81	53	0110101	1.13	85	1010101	1.45	117	1110101	1.77
22	0010110	0.82	54	0110110	1.14	86	1010110	1.46	118	1110110	1.78
23	0010111	0.83	55	0110111	1.15	87	1010111	1.47	119	1110111	1.79
24	0011000	0.84	56	0111000	1.16	88	1011000	1.48	120	1111000	1.80
25	0011001	0.85	57	0111001	1.17	89	1011001	1.49	121	1111001	1.81
26	0011010	0.86	58	0111010	1.18	90	1011010	1.50	122	1111010	1.82
27	0011011	0.87	59	0111011	1.19	91	1011011	1.51	123	1111011	1.83
28	0011100	0.88	60	0111100	1.20	92	1011100	1.52	124	1111100	1.84
29	0011101	0.89	61	0111101	1.21	93	1011101	1.53	125	1111101	1.85
30	0011110	0.90	62	0111110	1.22	94	1011110	1.54	126	1111110	1.86
31	0011111	0.91	63	0111111	1.23	95	1011111	1.55	127	1111111	1.87

### 8.6.3 CheckSum Bit (VOUT Register Only)

The CheckSum bit should be set by the Master controller to be the exclusive-NOR of the D[6:0] bits (odd parity). This will be used by the TPS56X20 to check that a valid data byte was received. If CheckSum is not equal to the exclusive-NOR of these bits, the TPS56X20 assumes that an error occurred during the data transmission, and it will not send an ACK bit, nor will it reset the VOUT to the received code (or, if the Control register, will not reset the register contents as requested). The Master should try again to send the data. When reading back the VOUT register, the parity bit is also sent back.

### 8.6.4 Control Registers

There are 4 control registers: Registers 0, 8, 9 and 24.

**Table 3. Summary of Default Control Bits**

CONTROL BIT(s)	DEFAULT (BINARY)	FUNCTION
VOUT[7:0]	0110010	VOUT code, 7 bits VOUT[6:0] + odd parity checksum bit at VOUT[7] Writing a valid code to this register also sets Internal Mode. Sending an invalid code (checksum incorrect) to this register does not change register contents or set Internal/Enable bits.
Internal Mode	0 (EXTERNAL mode)	1. If set to 1, the part switches to INTERNAL mode and VOUT register value controls output voltage. 2. Writing a valid code to the VOUT register sets this Internal Mode bit to 1. 3. The part can be set back to EXTERNAL control mode at any time by writing this bit to 0.
PGOOD Delay [1:0]	11	Part defaults to PGOOD Delay = 26.4µS
Hiccup Mode	1	Part defaults to Hiccup Mode On. If Hiccup Mode is enabled, do not turn on OVP Latchoff Mode and/or UVP Latchoff Mode.
ECO Mode	0	Part defaults to ECO Mode Off
DAC Settle [1:0]	11	Part defaults to DAC Settle = 25µS
Enable	0	Part defaults to Disabled. This bit can be set to 1 by writing the bit to 1. The external EN terminal being set to 1 overrides the register value (you cannot disable the part by writing a 0 if the EN terminal is high).
OVP Latchoff Mode Disable	1	Part defaults to Latchoff Mode Off. If Hiccup Mode is enabled, do not turn on OVP Latchoff Mode and/or UVP Latchoff Mode.
UVP Latchoff Mode Disable	1	Part defaults to Latchoff Mode Off. If Hiccup Mode is enabled, do not turn on OVP Latchoff Mode and/or UVP Latchoff Mode.
CurLim[2:0]	111	Selects default current limit value

**Enable:** This bit can be used to enable the regulator just like setting the **EN** terminal high. The **EN** terminal has priority (if **EN**=high, the Enable bit does nothing, the chip is already enabled). This allows the customer to tie EN to GND externally or leave the **EN** terminal floating (the terminal is pulled low internally) and subsequently enable the regulator by I<sup>2</sup>C software control.

**DAC Settle [1:0]:** When a new VOUT voltage is selected, this happens by setting an internal DAC to a new internal VREF voltage. If this happens instantly, the regulator loop will be thrown out of regulation and the DCAP2 loop must respond to bring the VOUT back into regulation at its new chosen value. This can cause VOUT overshoots (or undershoots) or head to high transient input currents. Therefore, an analog filter on the DAC output causes this internal VREF to change more slowly. The DAC Settle[1:0] bits change the filter time constant as follows:

DAC Settle [1:0]	Typical Filter Time Constant
00	6 µs
01	10 µs
10	15 µs
11	25 µs

The power-up default value of the DAC Settle[1:0] bits is 11.

**Internal Mode:** This bit can be interrogated to discover whether the chip is running in EXT Mode (using external resistor dividers to VFB terminal to set the output voltage) or INT Mode (using codes set in Output Voltage register to set the output voltage). Further, it can be set by the user to force either Internal or External mode. Writing a valid value to a VOUT register always sets *External* to 1 on the corresponding regulator.

In default, the TPS56X20 will start up into external mode and the output voltage is set by VFB with divider resistors. If starting up into internal VID mode is desired, the input voltage should be applied first, write Internal Mode bit to "1" the next, then enable the device by EN terminal or EN bit.



**Current Limit [2:0]:** Set the low-side valley current limit threshold for the regulator. Power-up default setting is [111].

	TPS56520	TPS56720	TPS56920	TPS56C20	
Current Limit [2:0]	Typical Current Limit	Typical Current Limit	Typical Current Limit	Typical Current Limit	Units
000	1.72	3	3.8	5.08	Amps
001	2.28	3.6	4.76	6.16	Amps
010	2.88	4.58	5.8	7.68	Amps
011	3.44	5.52	6.88	9.12	Amps
100	4.32	6.68	8.52	11.16	Amps
101	5.32	8.24	10.32	13.44	Amps
110	6.4	9.92	12.52	16.24	Amps
111	7.84	12.12	15.16	19.76	Amps

**PGOOD Delay [1:0]:** Especially for low load currents, large jumps in the I<sup>2</sup>C-controlled VOUT setting may have a long settling time compared to the UV/OV thresholds. If this happens, it will cause the PGOOD signal to temporarily indicate a fault condition. If this is not the desired behavior, it is possible to “blank” the PGOOD being pulled down for some number of  $\mu$ S according to the table below.

PGOOD Delay [1:0]	FUNCTION
00	Set delay from PGOOD fault to PGOOD terminal pulldown to 0 $\mu$ S
01	Set delay from PGOOD fault to PGOOD terminal pulldown to 6.6 $\mu$ S
10	Set delay from PGOOD fault to PGOOD terminal pulldown to 13.2 $\mu$ S
11	Set delay from PGOOD fault to PGOOD terminal pulldown to 26.4 $\mu$ S (Default)

On power-up, the delay defaults to 26.4  $\mu$ S. The user can reset the blanking time using these codes at any time without affecting any other device behavior.

### 8.6.5 Latchoff

Latchoff turns the output voltage off in the event of an overvoltage or undervoltage condition. V<sub>OUT</sub> will not be enabled again until the EN terminal or EN bit is cycled. By default Latchoff Mode is disabled, but overvoltage protection (OVP) and undervoltage protection (UVP) Latchoff Modes can be enabled by setting the OVP and UVP Latchoff Mode Off bits to zero. Power cycling Vin will reset these bits to their default values. If either Latchoff Mode is enabled, Hiccup Mode On should be disabled.





**Table 4. Design Example**

DESIGN PARAMETER	EXAMPLE VALUE
Input voltage range	4.5V to 17V
Output voltage	1.1V
Transient response, 3A-9A load step	$\Delta V_{OUT} = \pm 5\%$
Output voltage ripple	25mV
Input ripple voltage	400mA
Output current rating	12A
Operating Frequency	500kHz

### 9.2.1.2 Detailed Design Procedure

#### 9.2.1.2.1 Output Voltage Resistors Selection

The output voltage is set with a resistor divider from the output node to the VFB terminal. It is recommended to use 1% tolerance or better divider resistors. Start by using [Equation 3](#) to calculate  $V_{OUT}$ .

To improve efficiency at light loads consider using larger value resistors, high resistance is more susceptible to noise, and the voltage errors from the VFB input current are more noticeable.

$$V_{OUT} = 0.6 \times \left( 1 + \frac{R5}{R6} \right) \quad (3)$$

##### 9.2.1.2.1.1 Output Filter Selection

The output filter used with the TPS56X20 is an LC circuit. This LC filter has double pole at:

$$F_P = \frac{1}{2\pi\sqrt{L_{OUT} \times C_{OUT}}} \quad (4)$$

At low frequencies, the overall loop gain is set by the output set-point resistor divider network and the internal gain of the TPS56X20. The low frequency phase is 180 degrees. At the output filter pole frequency, the gain rolls off at a  $-40$  dB per decade rate and the phase drops rapidly. D-CAP2™ introduces a high frequency zero that reduces the gain roll off to  $-20$  dB per decade and increases the phase to 90 degrees one decade above the zero frequency. The inductor and capacitor selected for the output filter must be selected so that the double pole of [Equation 4](#) is located below the high frequency zero but close enough that the phase boost provided by the high frequency zero provides adequate phase margin for a stable circuit. To meet this requirement use the values recommended in [Table 5](#).

**Table 5. Recommended Component Values**

Output Voltage (V)	R5 (k $\Omega$ )	R6 (k $\Omega$ )	C8 (pF)	L1 ( $\mu$ H)	C7 ( $\mu$ F)
1	14.7	22	DNP	1.0-2.2	44-100
1.1	18.2	22	DNP	1.0-2.2	44-100
1.2	22	22	DNP	1.0-2.2	44-100
1.5	33	22	DNP	1.0-2.2	44-100
1.8	44.2	22	DNP	1.0-2.2	44-100

For higher output voltages additional phase boost can be achieved by adding a feed forward capacitor (C6) in parallel with R5.

The inductor peak-to-peak ripple current, peak current and RMS current are calculated using [Equation 5](#), [Equation 6](#) and [Equation 7](#). The inductor saturation current rating must be greater than the calculated peak current and the RMS or heating current rating must be greater than the calculated RMS current. Use 500 kHz for  $f_{SW}$ .

Use 500 kHz for  $f_{SW}$ . Make sure the chosen inductor is rated for the peak current of [Equation 6](#) and the RMS current of [Equation 7](#).

$$I_{P-P} = \frac{V_{OUT}}{V_{IN(MAX)}} \times \frac{V_{IN(MAX)} - V_{OUT}}{L_O \times f_{SW}} \quad (5)$$

$$I_{PEAK} = I_O + \frac{I_{P-P}}{2} \quad (6)$$

$$I_{LO(RMS)} = \sqrt{I_O^2 + \frac{1}{12} I_{P-P}^2} \quad (7)$$

The capacitor value and ESR determines the amount of output voltage ripple. The TPS56X20 is intended for use with ceramic or other low ESR capacitors. Recommended values range from 44µF to 100µF. Use Equation 8 to determine the required RMS current rating for the output capacitor.

$$I_{Co(RMS)} = \frac{V_{OUT} \times (V_{IN} - V_{OUT})}{\sqrt{12} \times V_{IN} \times L_O \times f_{SW}} \quad (8)$$

#### 9.2.1.2.2 Input Capacitor Selection

The TPS56X20 requires an input decoupling capacitor and a bulk capacitor depending on the application. A ceramic capacitor of 20µF or above is recommended for the decoupling capacitors from PVIN to PGND. Additionally, a 4.7 µF ceramic capacitor from VIN to GND is also recommended. The capacitors voltage rating needs to be greater than the maximum input voltage.

#### 9.2.1.2.3 Bootstrap Capacitor Selection

The 0.1 µF ceramic capacitors must be connected between the VBST to SW terminals for proper operation. It is recommended to use ceramic capacitors with a dielectric of X5R or better.

#### 9.2.1.2.4 VREG5 Capacitor Selection

For the TPS56920/720/520, a 2.2 µF ceramic capacitor must be connected between the VREG5 to GND terminals for proper operation.

### 9.2.2 TPS56520, TPS56720 and TPS56920 Application Performance Curves

$V_{IN} = 12\text{ V}$ ,  $V_{OUT} = 1.0\text{ V}$ ,  $T_a = 25\text{ }^\circ\text{C}$ , unless otherwise specified.

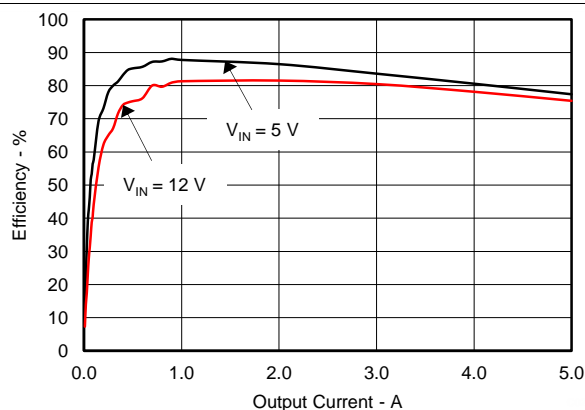

Figure 32. TPS56520 Efficiency

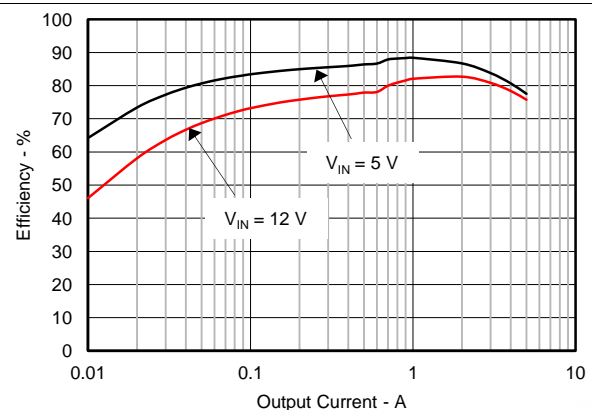

Figure 33. TPS56520 Eco-mode™ Efficiency

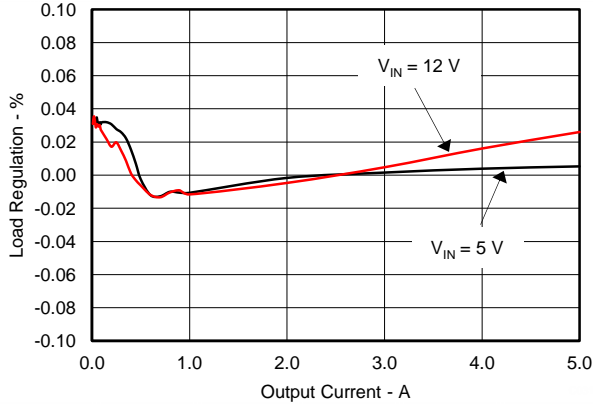

Figure 34. TPS56520 Load Regulation

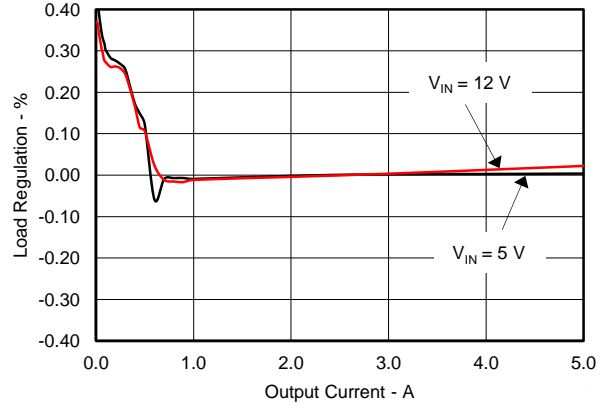

Figure 35. TPS56520 Load Regulation with Eco-mode™

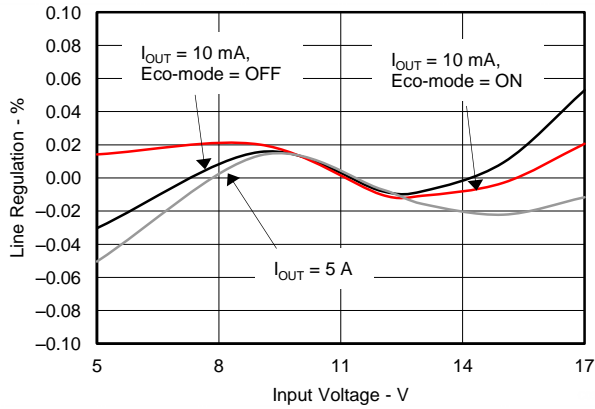

Figure 36. TPS56520 Line Regulation

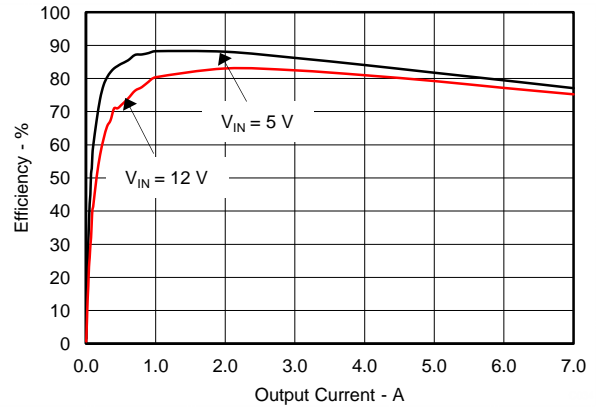

Figure 37. TPS56720 Efficiency

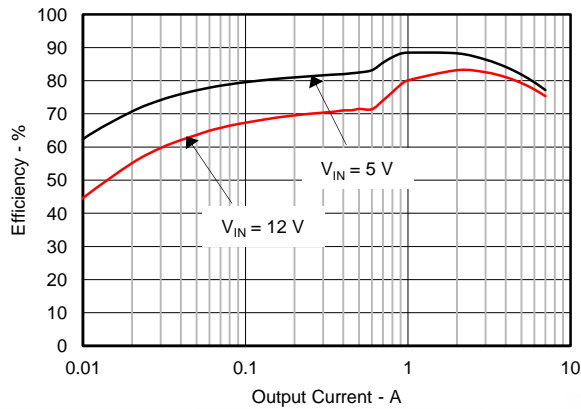

Figure 38. TPS56720 Eco-mode™ Efficiency

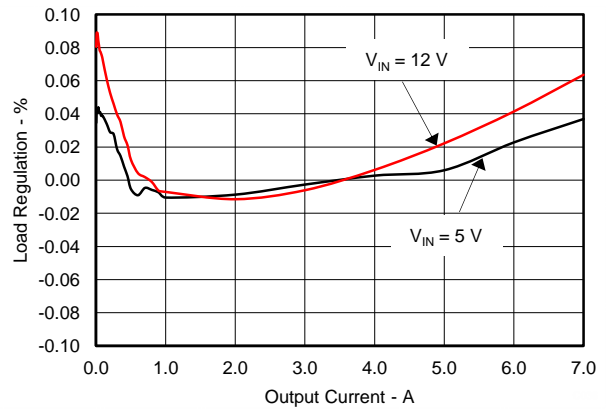

Figure 39. TPS56720 Load Regulation

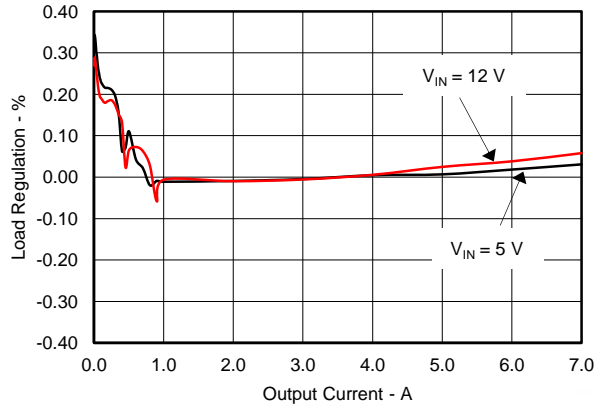

Figure 40. TPS56720 Load Regulation with Eco-mode™

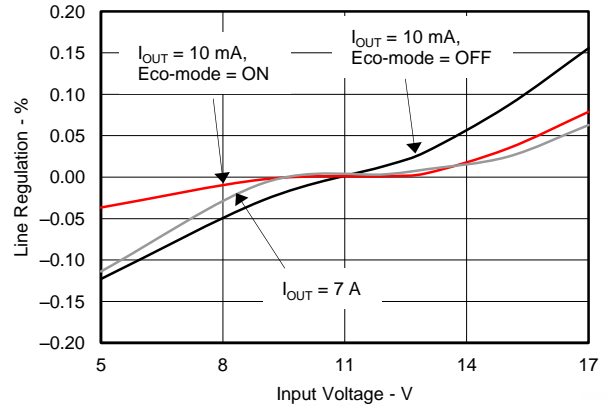

Figure 41. TPS56720 Line Regulation

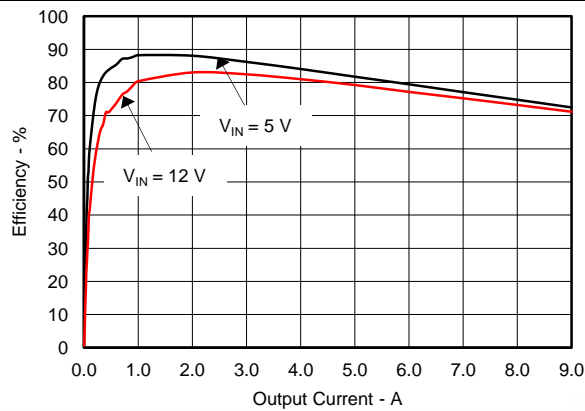

Figure 42. TPS56920 Efficiency

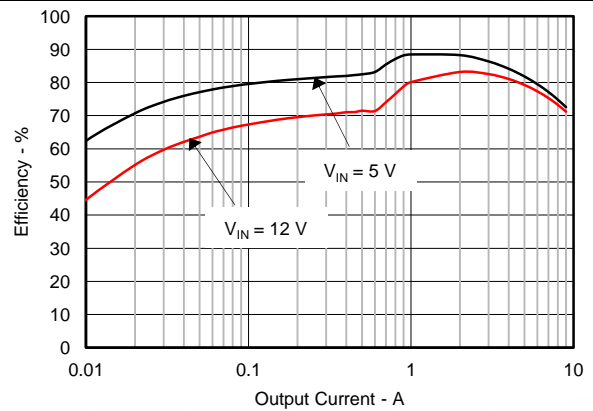

Figure 43. TPS56920 Eco-mode™ Efficiency

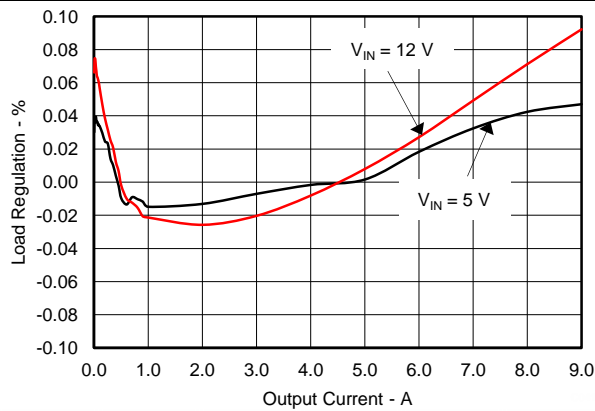

Figure 44. TPS56920 Load Regulation

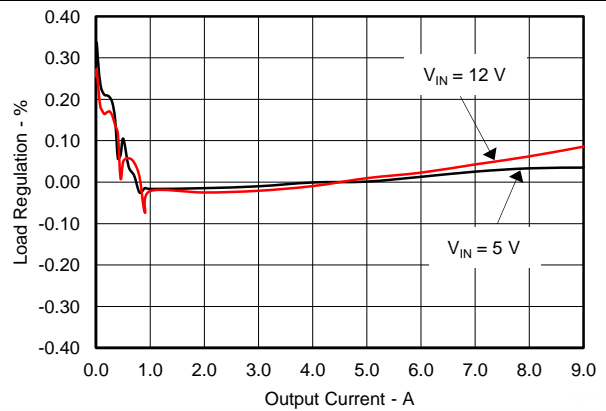
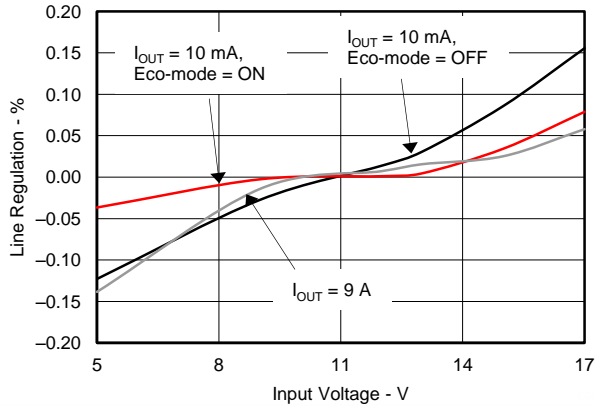
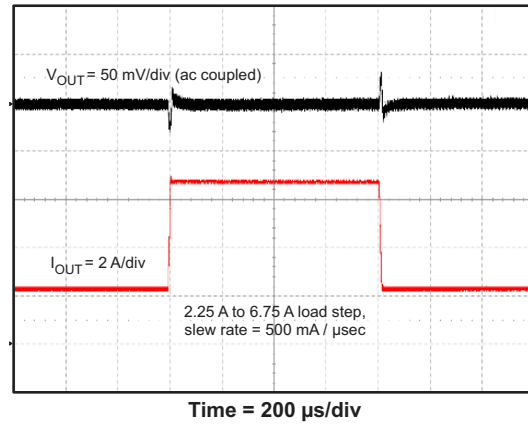

Figure 45. TPS56520 Load Regulation with Eco-mode™



**Figure 46. TPS56920 Line Regulation**



**Figure 47. TPS56920 Transient Response**

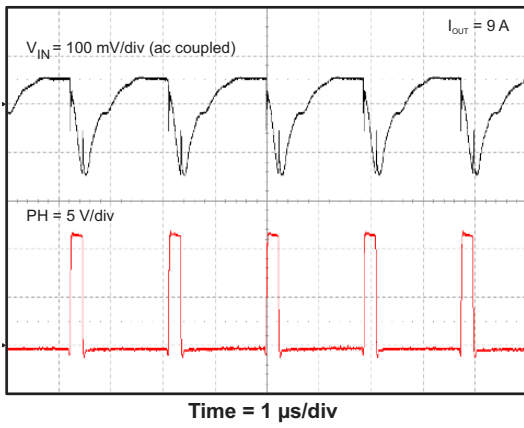

**Figure 48. TPS56920 Input Voltage Ripple**

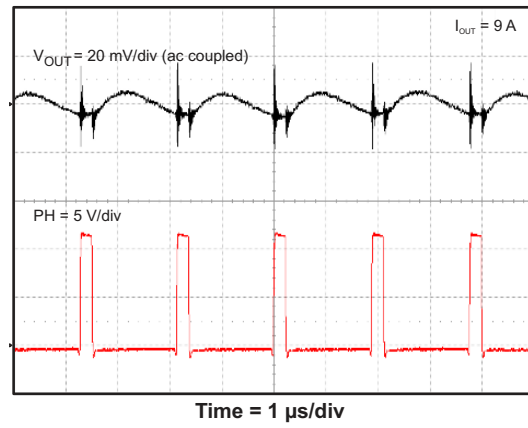

**Figure 49. TPS56920 Output Voltage Ripple**

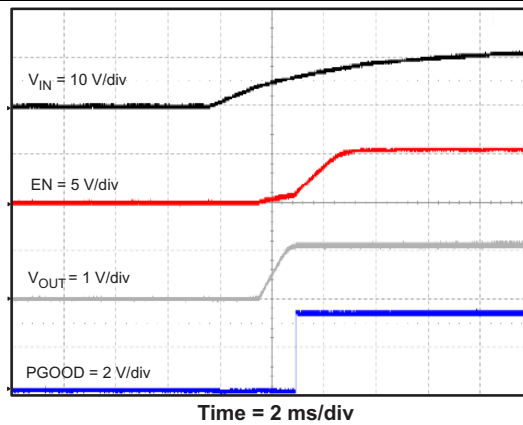

**Figure 50. TPS56920 Start Up Relative to V<sub>IN</sub>**

### 9.2.3 TPS56C20 12-A Converter

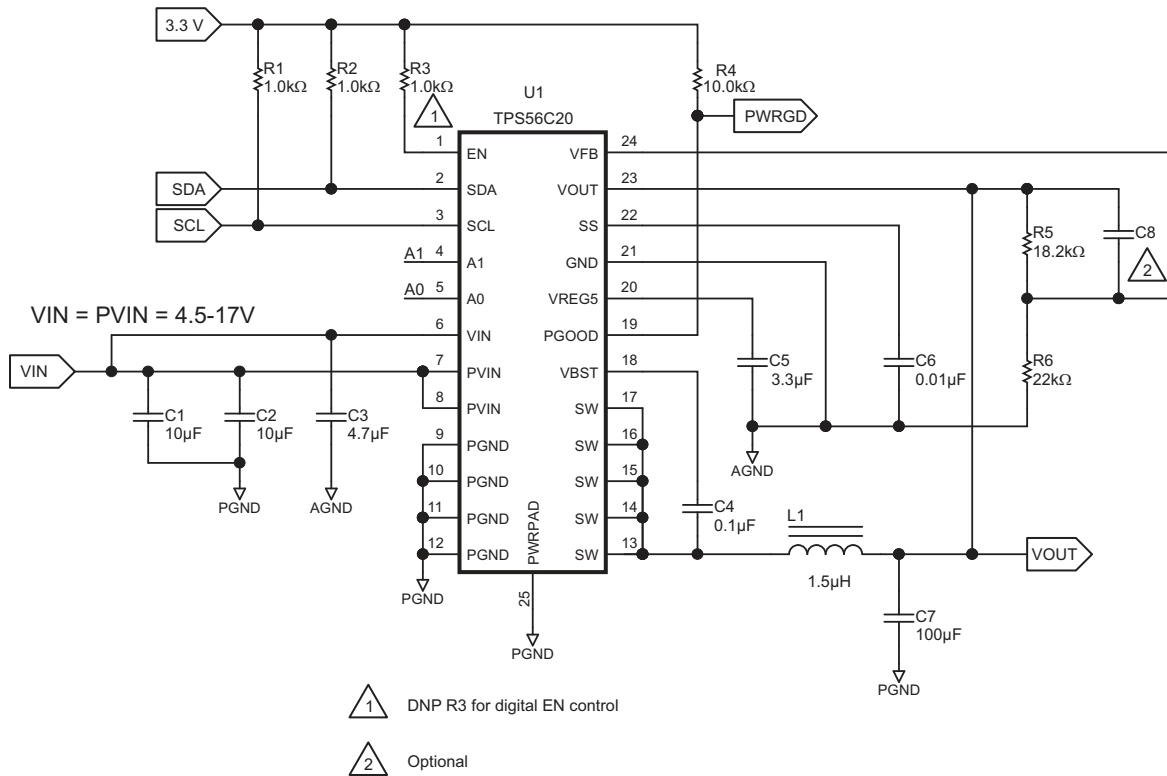

Figure 51. Typical Schematic – TPS56C20

#### 9.2.3.1 Design Requirements

To begin the design process, the user must know a few application parameters:

- Input voltage range
- Output voltage
- Output current
- Output voltage ripple
- Input voltage ripple

#### 9.2.3.2 Design Procedure

Follow the design procedure for the TPS56X20 converter listed above. For the TPS56C20, a 3.3 µF ceramic capacitor must be connected between the VREG5 to GND terminals for proper operation. Do not load the VREG5 terminal with any other load. It is recommended to use a ceramic capacitor with a dielectric of X5R or better.

#### 9.2.3.3 TPS56C20 Application Performance Curves

$V_{IN} = 12\text{ V}$ ,  $V_{OUT} = 1.0\text{ V}$ ,  $T_a = 25\text{ }^\circ\text{C}$ , unless otherwise specified.

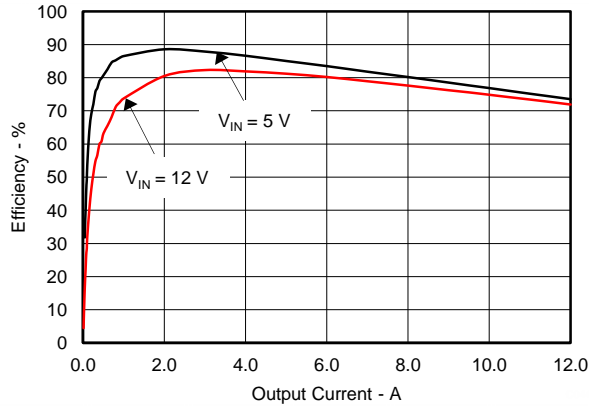

Figure 52. TPS56C20 Efficiency

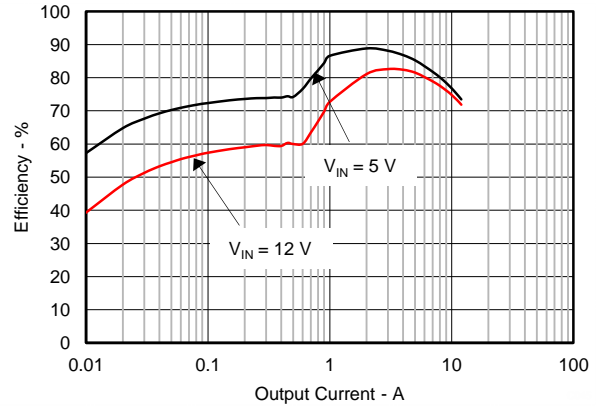

Figure 53. TPS56C20 Eco-mode™ Efficiency

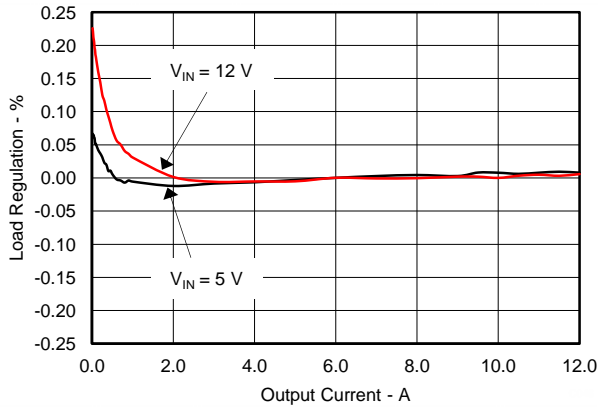

Figure 54. TPS56C20 Load Regulation

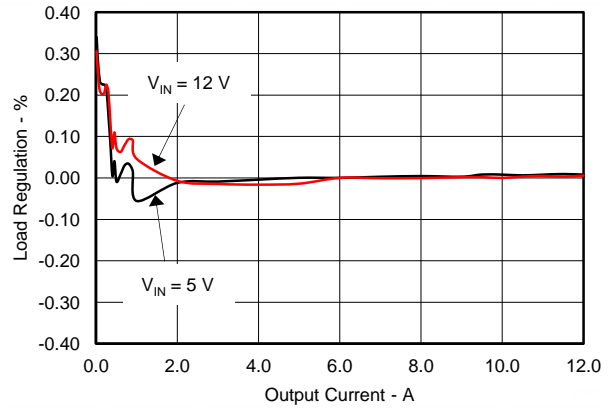

Figure 55. TPS56C20 Load Regulation with Eco-mode™

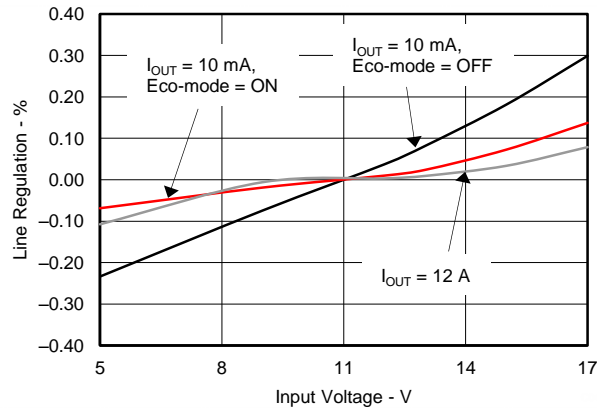

Figure 56. TPS56C20 Line Regulation

## 10 Power Supply Recommendations

The devices are designed to operate from an input supply range between 4.5 V and 17 V. This input supply must be well regulated. If the input supply is located more than a few inches from the TPS56X20 device, additional bulk capacitance may be required in addition to the ceramic bypass capacitors.

## 11 Layout

### 11.1 Layout Guidelines

1. Keep the input switching current loop as small as possible. And avoid the input switching current through thermal Pad.
2. Keep the SW node as physically small and short as possible to minimize parasitic capacitance and inductance and to minimize radiated emissions. Kelvin connections should be brought from the output to the feedback terminal of the device.
3. Keep analog and non-switching components away from switching components.
4. Make a single point connection from the signal ground to power ground.
5. Do not allow switching current to flow under the device.
6. Keep the pattern lines for VIN and PGND broad.
7. Exposed pad of device must be connected to PGND with solder.
8. VREG5 capacitor should be placed near the device, and connected to GND.
9. Output capacitor should be connected to a broad pattern of the PGND.
10. Voltage feedback loop should be as short as possible, and preferably with ground shield.
11. Kelvin connections should be brought from the output to the feedback terminal of the device.
12. Providing sufficient via is preferable for VIN, SW and PGND connection.
13. PCB pattern for VIN, SW, and PGND should be as broad as possible.
14. Input capacitors should be placed as near as possible to the device.
15. The topside and the bottom side of the PCB should be filled with as much ground plane as possible that has an uninterrupted heat flow path. The ground plane should be made as large as possible. The PVIN cap should connect to PGND and the VIN cap should connect to GND.



## 11.2 Layout Example

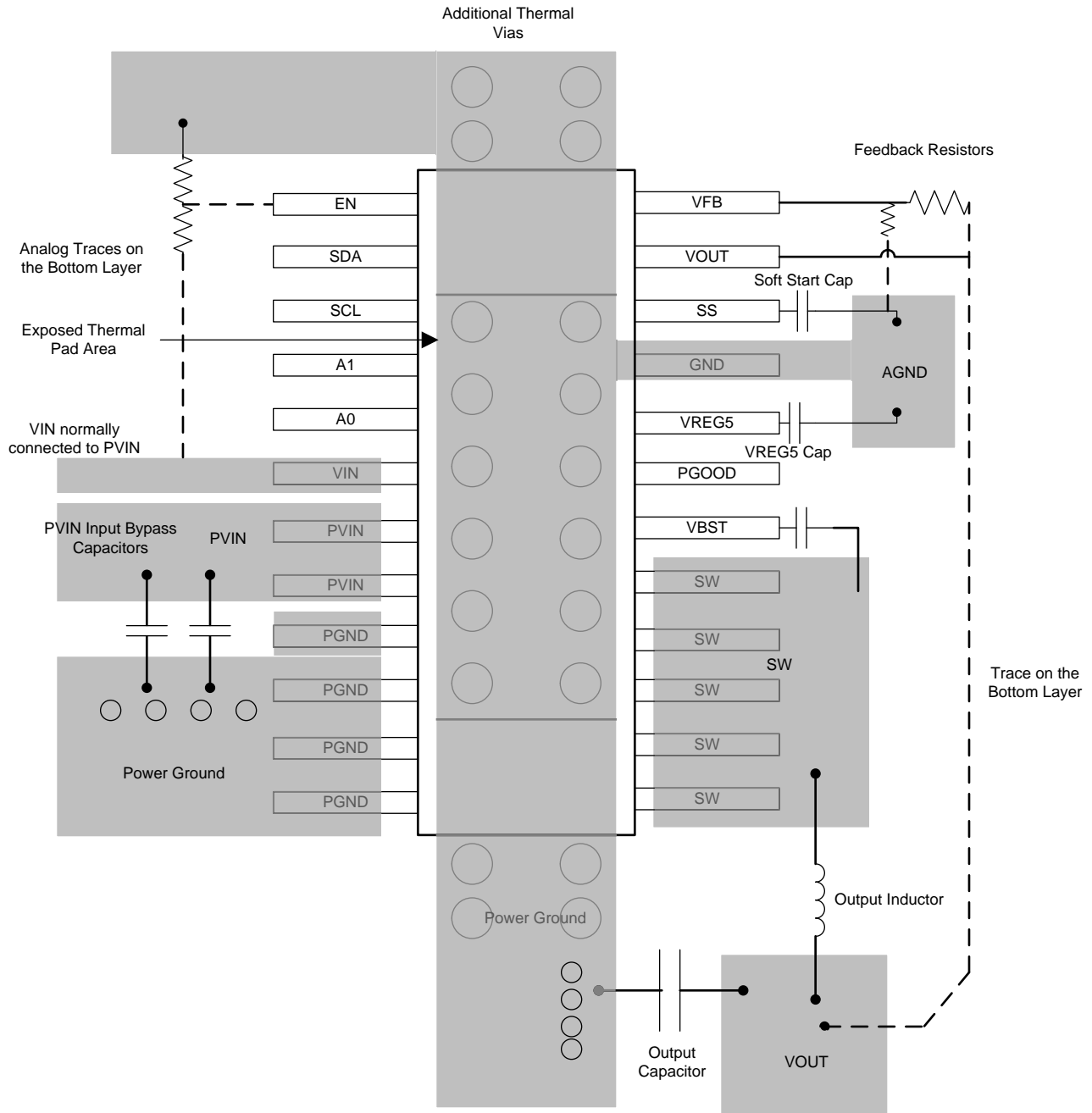

Figure 57. TPS56X20 Board Layout

## 12 Device and Documentation Support

### 12.1 Device Support

#### 12.1.1 Development Support

For the TPS56C20 Pspice model go to [www.ti.com/product/tps56x20](http://www.ti.com/product/tps56x20).

For the TPS56920 Pspice model go to [www.ti.com/product/tps56x20](http://www.ti.com/product/tps56x20).

For the TPS56720 Pspice model go to [www.ti.com/product/tps56x20](http://www.ti.com/product/tps56x20).

For the TPS56520 Pspice model go to [www.ti.com/product/tps56x20](http://www.ti.com/product/tps56x20).

### 12.2 Documentation Support

#### 12.2.1 Related Documentation

TPS56X20-614, 12-A, SWIFT™ Regulator Evaluation Module User's Guide, [SBAU227](#)

### 12.3 Related Links

The table below lists quick access links. Categories include technical documents, support and community resources, tools and software, and quick access to sample or buy.

**Table 6. Related Links**

PARTS	PRODUCT FOLDER	SAMPLE & BUY	TECHNICAL DOCUMENTS	TOOLS & SOFTWARE	SUPPORT & COMMUNITY
TPS56C20	<a href="#">Click here</a>	<a href="#">Click here</a>	<a href="#">Click here</a>	<a href="#">Click here</a>	<a href="#">Click here</a>
TPS56920	<a href="#">Click here</a>	<a href="#">Click here</a>	<a href="#">Click here</a>	<a href="#">Click here</a>	<a href="#">Click here</a>
TPS56720	<a href="#">Click here</a>	<a href="#">Click here</a>	<a href="#">Click here</a>	<a href="#">Click here</a>	<a href="#">Click here</a>
TPS56520	<a href="#">Click here</a>	<a href="#">Click here</a>	<a href="#">Click here</a>	<a href="#">Click here</a>	<a href="#">Click here</a>

### 12.4 Trademarks

D-CAP2, Eco-mode, PowerPAD are trademarks of Texas Instruments.

### 12.5 Electrostatic Discharge Caution



These devices have limited built-in ESD protection. The leads should be shorted together or the device placed in conductive foam during storage or handling to prevent electrostatic damage to the MOS gates.

### 12.6 Glossary

[SLYZ022](#) — *TI Glossary*.

This glossary lists and explains terms, acronyms, and definitions.

## 13 Mechanical, Packaging, and Orderable Information

The following pages include mechanical packaging and orderable information. This information is the most current data available for the designated devices. This data is subject to change without notice and revision of this document. For browser-based versions of this data sheet, refer to the left-hand navigation.

**PACKAGING INFORMATION**

Orderable Device	Status (1)	Package Type	Package Drawing	Pins	Package Qty	Eco Plan (2)	Lead finish/ Ball material (6)	MSL Peak Temp (3)	Op Temp (°C)	Device Marking (4/5)	Samples
TPS56520PWP	ACTIVE	HTSSOP	PWP	20	70	RoHS & Green	NIPDAU	Level-2-260C-1 YEAR	-40 to 85	56520	<a href="#">Samples</a>
TPS56520PWPR	ACTIVE	HTSSOP	PWP	20	2000	RoHS & Green	NIPDAU	Level-2-260C-1 YEAR	-40 to 85	56520	<a href="#">Samples</a>
TPS56720PWP	ACTIVE	HTSSOP	PWP	20	70	RoHS & Green	NIPDAU	Level-2-260C-1 YEAR	-40 to 85	56720	<a href="#">Samples</a>
TPS56720PWPR	ACTIVE	HTSSOP	PWP	20	2000	RoHS & Green	NIPDAU	Level-2-260C-1 YEAR	-40 to 85	56720	<a href="#">Samples</a>
TPS56920PWP	ACTIVE	HTSSOP	PWP	20	70	RoHS & Green	NIPDAU	Level-2-260C-1 YEAR	-40 to 85	56920	<a href="#">Samples</a>
TPS56920PWPR	ACTIVE	HTSSOP	PWP	20	2000	RoHS & Green	NIPDAU	Level-2-260C-1 YEAR	-40 to 85	56920	<a href="#">Samples</a>
TPS56C20PWP	ACTIVE	HTSSOP	PWP	24	60	RoHS & Green	NIPDAU	Level-2-260C-1 YEAR	-40 to 85	56C20	<a href="#">Samples</a>
TPS56C20PWPR	ACTIVE	HTSSOP	PWP	24	2000	RoHS & Green	NIPDAU	Level-2-260C-1 YEAR	-40 to 85	56C20	<a href="#">Samples</a>

(1) The marketing status values are defined as follows:

**ACTIVE:** Product device recommended for new designs.

**LIFEBUY:** TI has announced that the device will be discontinued, and a lifetime-buy period is in effect.

**NRND:** Not recommended for new designs. Device is in production to support existing customers, but TI does not recommend using this part in a new design.

**PREVIEW:** Device has been announced but is not in production. Samples may or may not be available.

**OBSOLETE:** TI has discontinued the production of the device.

(2) **RoHS:** TI defines "RoHS" to mean semiconductor products that are compliant with the current EU RoHS requirements for all 10 RoHS substances, including the requirement that RoHS substance do not exceed 0.1% by weight in homogeneous materials. Where designed to be soldered at high temperatures, "RoHS" products are suitable for use in specified lead-free processes. TI may reference these types of products as "Pb-Free".

**RoHS Exempt:** TI defines "RoHS Exempt" to mean products that contain lead but are compliant with EU RoHS pursuant to a specific EU RoHS exemption.

**Green:** TI defines "Green" to mean the content of Chlorine (Cl) and Bromine (Br) based flame retardants meet JS709B low halogen requirements of <=1000ppm threshold. Antimony trioxide based flame retardants must also meet the <=1000ppm threshold requirement.

(3) MSL, Peak Temp. - The Moisture Sensitivity Level rating according to the JEDEC industry standard classifications, and peak solder temperature.

(4) There may be additional marking, which relates to the logo, the lot trace code information, or the environmental category on the device.

(5) Multiple Device Markings will be inside parentheses. Only one Device Marking contained in parentheses and separated by a "~" will appear on a device. If a line is indented then it is a continuation of the previous line and the two combined represent the entire Device Marking for that device.

<sup>(6)</sup> Lead finish/Ball material - Orderable Devices may have multiple material finish options. Finish options are separated by a vertical ruled line. Lead finish/Ball material values may wrap to two lines if the finish value exceeds the maximum column width.

**Important Information and Disclaimer:** The information provided on this page represents TI's knowledge and belief as of the date that it is provided. TI bases its knowledge and belief on information provided by third parties, and makes no representation or warranty as to the accuracy of such information. Efforts are underway to better integrate information from third parties. TI has taken and continues to take reasonable steps to provide representative and accurate information but may not have conducted destructive testing or chemical analysis on incoming materials and chemicals. TI and TI suppliers consider certain information to be proprietary, and thus CAS numbers and other limited information may not be available for release.

In no event shall TI's liability arising out of such information exceed the total purchase price of the TI part(s) at issue in this document sold by TI to Customer on an annual basis.

**TAPE AND REEL INFORMATION**

**QUADRANT ASSIGNMENTS FOR PIN 1 ORIENTATION IN TAPE**

\*All dimensions are nominal

Device	Package Type	Package Drawing	Pins	SPQ	Reel Diameter (mm)	Reel Width W1 (mm)	A0 (mm)	B0 (mm)	K0 (mm)	P1 (mm)	W (mm)	Pin1 Quadrant
TPS56520PWPR	HTSSOP	PWP	20	2000	330.0	16.4	6.95	7.1	1.6	8.0	16.0	Q1
TPS56720PWPR	HTSSOP	PWP	20	2000	330.0	16.4	6.95	7.1	1.6	8.0	16.0	Q1
TPS56920PWPR	HTSSOP	PWP	20	2000	330.0	16.4	6.95	7.1	1.6	8.0	16.0	Q1
TPS56C20PWPR	HTSSOP	PWP	24	2000	330.0	16.4	6.95	8.3	1.6	8.0	16.0	Q1

**TAPE AND REEL BOX DIMENSIONS**

\*All dimensions are nominal

Device	Package Type	Package Drawing	Pins	SPQ	Length (mm)	Width (mm)	Height (mm)
TPS56520PWPR	HTSSOP	PWP	20	2000	350.0	350.0	43.0
TPS56720PWPR	HTSSOP	PWP	20	2000	350.0	350.0	43.0
TPS56920PWPR	HTSSOP	PWP	20	2000	350.0	350.0	43.0
TPS56C20PWPR	HTSSOP	PWP	24	2000	350.0	350.0	43.0

**TUBE**

\*All dimensions are nominal

Device	Package Name	Package Type	Pins	SPQ	L (mm)	W (mm)	T (μm)	B (mm)
TPS56520PWP	PWP	HTSSOP	20	70	530	10.2	3600	3.5
TPS56720PWP	PWP	HTSSOP	20	70	530	10.2	3600	3.5
TPS56920PWP	PWP	HTSSOP	20	70	530	10.2	3600	3.5
TPS56C20PWP	PWP	HTSSOP	24	60	530	10.2	3600	3.5

## GENERIC PACKAGE VIEW

**PWP 24**

**PowerPAD™ TSSOP - 1.2 mm max height**

4.4 x 7.6, 0.65 mm pitch

PLASTIC SMALL OUTLINE

This image is a representation of the package family, actual package may vary.  
Refer to the product data sheet for package details.

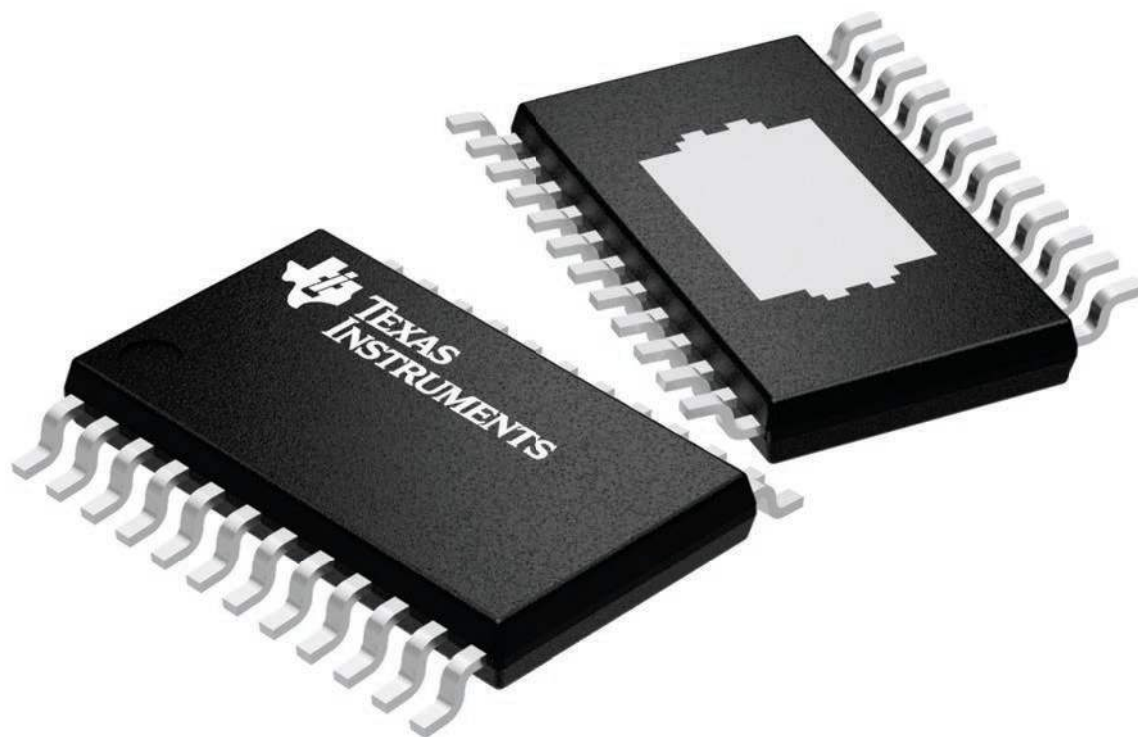

4224742/B



# MECHANICAL DATA

PWP (R-PDSO-G24)

PowerPAD™ PLASTIC SMALL OUTLINE

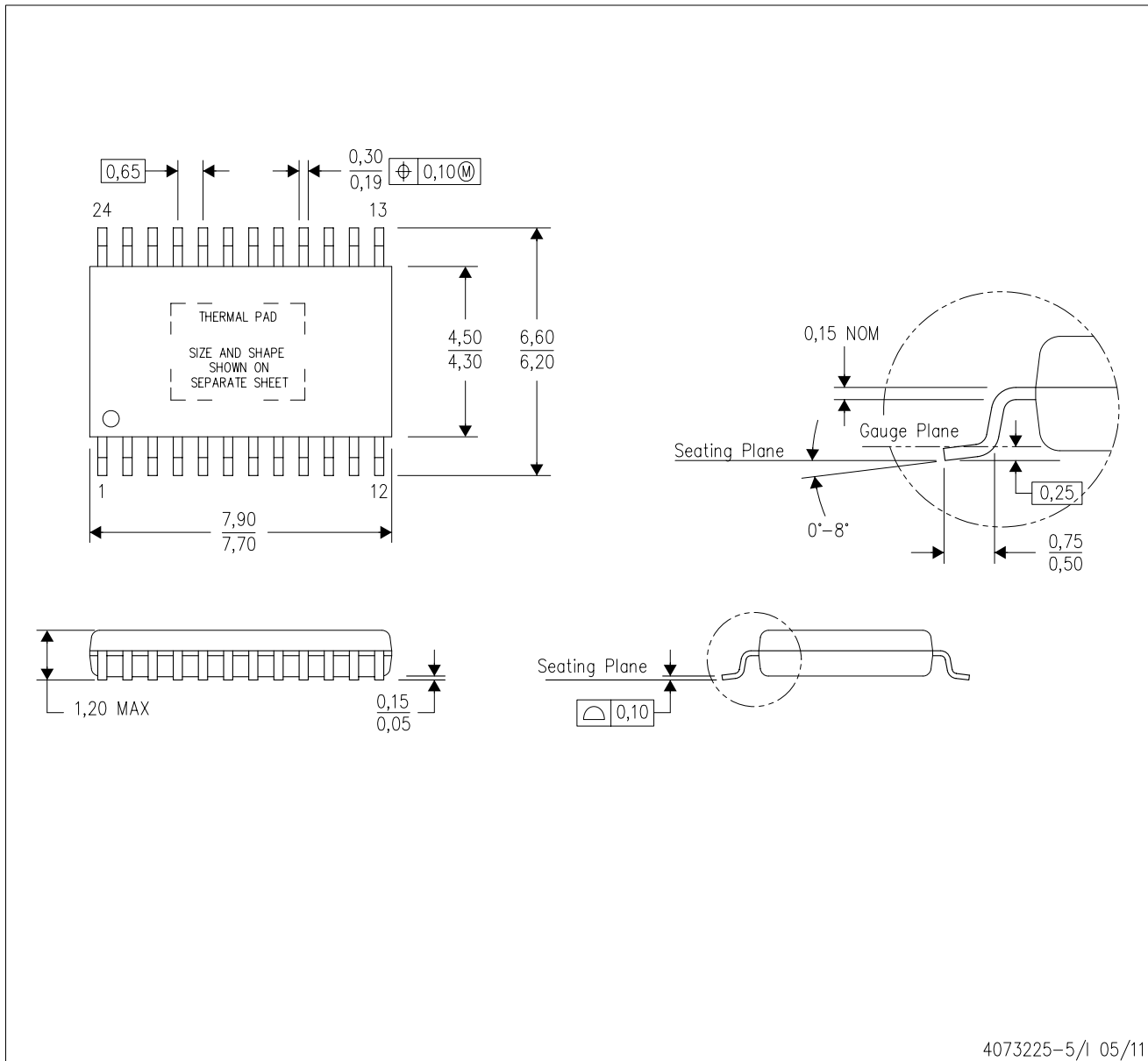

- NOTES:
- All linear dimensions are in millimeters.
  - This drawing is subject to change without notice.
  - Body dimensions do not include mold flash or protrusions. Mold flash and protrusion shall not exceed 0.15 per side.
  - This package is designed to be soldered to a thermal pad on the board. Refer to Technical Brief, PowerPad Thermally Enhanced Package, Texas Instruments Literature No. SLMA002 for information regarding recommended board layout. This document is available at [www.ti.com](http://www.ti.com) <<http://www.ti.com>>.
  - See the additional figure in the Product Data Sheet for details regarding the exposed thermal pad features and dimensions.
  - Falls within JEDEC MO-153

PowerPAD is a trademark of Texas Instruments.



# MECHANICAL DATA

PWP (R-PDSO-G20)

PowerPAD™ PLASTIC SMALL OUTLINE

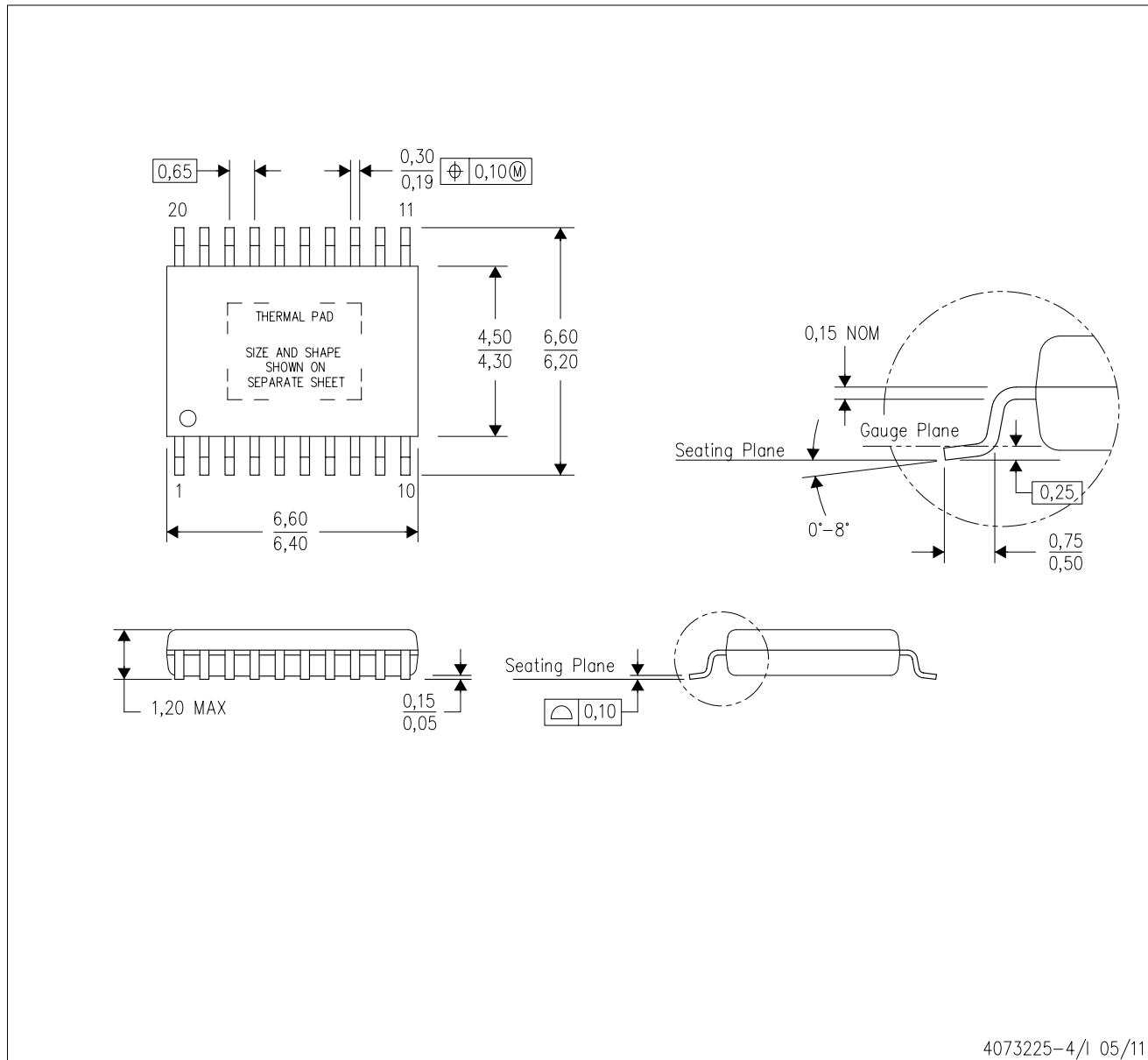

4073225-4/1 05/11

- NOTES:
- All linear dimensions are in millimeters.
  - This drawing is subject to change without notice.
  - Body dimensions do not include mold flash or protrusions. Mold flash and protrusion shall not exceed 0.15 per side.
  - This package is designed to be soldered to a thermal pad on the board. Refer to Technical Brief, PowerPad Thermally Enhanced Package, Texas Instruments Literature No. SLMA002 for information regarding recommended board layout. This document is available at [www.ti.com](http://www.ti.com) <<http://www.ti.com>>.
  - See the additional figure in the Product Data Sheet for details regarding the exposed thermal pad features and dimensions.
  - Falls within JEDEC MO-153

PowerPAD is a trademark of Texas Instruments.

# THERMAL PAD MECHANICAL DATA

## PWP (R-PDSO-G20) PowerPAD™ SMALL PLASTIC OUTLINE

### THERMAL INFORMATION

This PowerPAD™ package incorporates an exposed thermal pad that is designed to be attached to a printed circuit board (PCB). The thermal pad must be soldered directly to the PCB. After soldering, the PCB can be used as a heatsink. In addition, through the use of thermal vias, the thermal pad can be attached directly to the appropriate copper plane shown in the electrical schematic for the device, or alternatively, can be attached to a special heatsink structure designed into the PCB. This design optimizes the heat transfer from the integrated circuit (IC).

For additional information on the PowerPAD package and how to take advantage of its heat dissipating abilities, refer to Technical Brief, PowerPAD Thermally Enhanced Package, Texas Instruments Literature No. SLMA002 and Application Brief, PowerPAD Made Easy, Texas Instruments Literature No. SLMA004. Both documents are available at [www.ti.com](http://www.ti.com).

The exposed thermal pad dimensions for this package are shown in the following illustration.

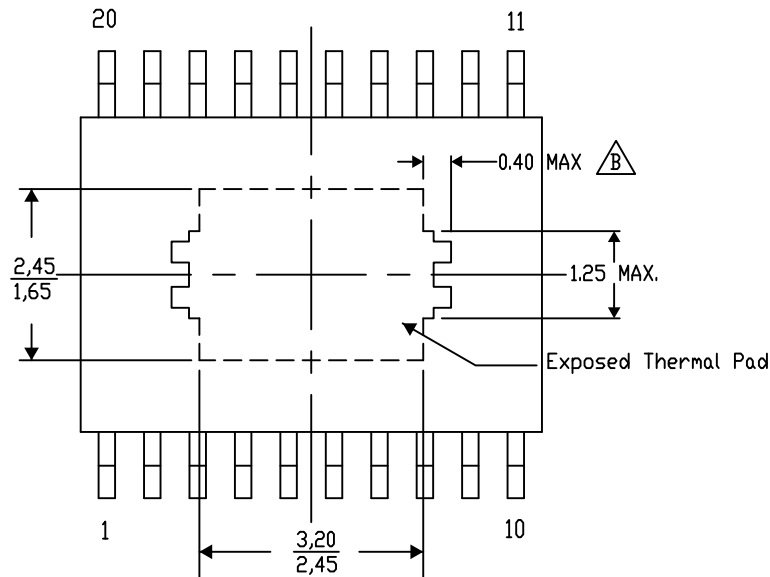

Top View

Exposed Thermal Pad Dimensions

4206332-18/AO 01/16

NOTE: A. All linear dimensions are in millimeters

$\triangle B$  Exposed tie strap features may not be present.

PowerPAD is a trademark of Texas Instruments

PWP (R-PDSO-G20)

PowerPAD™ PLASTIC SMALL OUTLINE

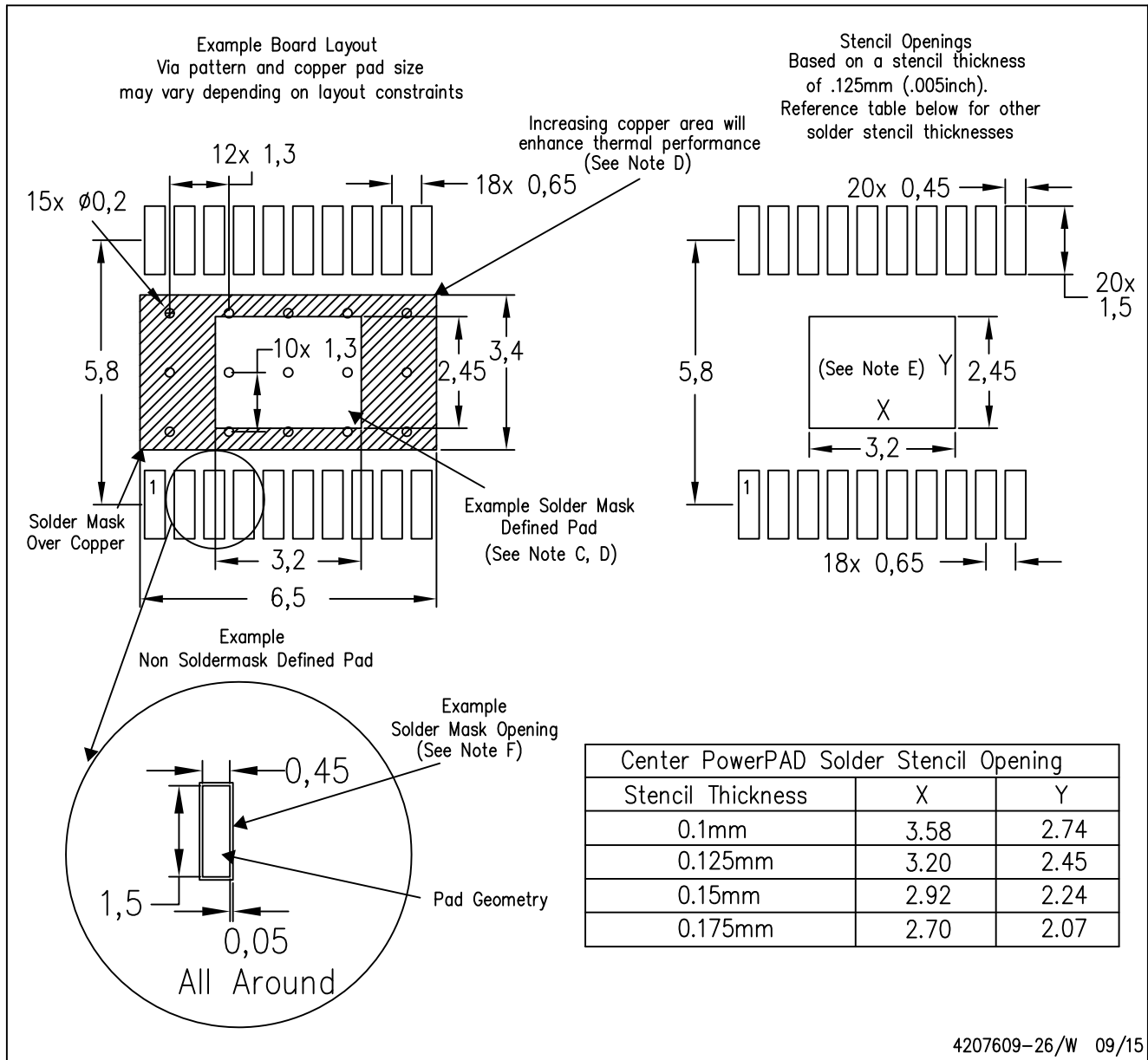

4207609-26/W 09/15

- NOTES:
- A. All linear dimensions are in millimeters.
  - B. This drawing is subject to change without notice.
  - C. Customers should place a note on the circuit board fabrication drawing not to alter the center solder mask defined pad.
  - D. This package is designed to be soldered to a thermal pad on the board. Refer to Technical Brief, PowerPad Thermally Enhanced Package, Texas Instruments Literature No. SLMA002, SLMA004, and also the Product Data Sheets for specific thermal information, via requirements, and recommended board layout. These documents are available at [www.ti.com](http://www.ti.com) <<http://www.ti.com>>. Publication IPC-7351 is recommended for alternate designs.
  - E. Laser cutting apertures with trapezoidal walls and also rounding corners will offer better paste release. Customers should contact their board assembly site for stencil design recommendations. Example stencil design based on a 50% volumetric metal load solder paste. Refer to IPC-7525 for other stencil recommendations.
  - F. Customers should contact their board fabrication site for solder mask tolerances between and around signal pads.

## IMPORTANT NOTICE AND DISCLAIMER

TI PROVIDES TECHNICAL AND RELIABILITY DATA (INCLUDING DATA SHEETS), DESIGN RESOURCES (INCLUDING REFERENCE DESIGNS), APPLICATION OR OTHER DESIGN ADVICE, WEB TOOLS, SAFETY INFORMATION, AND OTHER RESOURCES "AS IS" AND WITH ALL FAULTS, AND DISCLAIMS ALL WARRANTIES, EXPRESS AND IMPLIED, INCLUDING WITHOUT LIMITATION ANY IMPLIED WARRANTIES OF MERCHANTABILITY, FITNESS FOR A PARTICULAR PURPOSE OR NON-INFRINGEMENT OF THIRD PARTY INTELLECTUAL PROPERTY RIGHTS.

These resources are intended for skilled developers designing with TI products. You are solely responsible for (1) selecting the appropriate TI products for your application, (2) designing, validating and testing your application, and (3) ensuring your application meets applicable standards, and any other safety, security, regulatory or other requirements.

These resources are subject to change without notice. TI grants you permission to use these resources only for development of an application that uses the TI products described in the resource. Other reproduction and display of these resources is prohibited. No license is granted to any other TI intellectual property right or to any third party intellectual property right. TI disclaims responsibility for, and you will fully indemnify TI and its representatives against, any claims, damages, costs, losses, and liabilities arising out of your use of these resources.

TI's products are provided subject to [TI's Terms of Sale](#) or other applicable terms available either on [ti.com](http://ti.com) or provided in conjunction with such TI products. TI's provision of these resources does not expand or otherwise alter TI's applicable warranties or warranty disclaimers for TI products.

TI objects to and rejects any additional or different terms you may have proposed.

Mailing Address: Texas Instruments, Post Office Box 655303, Dallas, Texas 75265  
Copyright © 2022, Texas Instruments Incorporated