



Main

| | |
|---------------------------------|---------------------------------------|
| Range of Product | Harmony 9001SK |
| Product or Component Type | Push-button |
| Device short name | 9001SK |
| Type of operator | Spring return |
| Operator profile | 7 colours choice projecting, unmarked |
| Operator additional information | Without guard |

Complementary

| | |
|---|--|
| Bezel material | Plastic |
| Mounting diameter | 1.18 in (30 mm) |
| Shape of signaling unit head | Octagonal |
| Contacts type and composition | 1 NO |
| Contact operation | Standard |
| Connections - terminals | Screw clamp terminals 1 x 0.22...2 x 1.5 mm ² EN/IEC 60947-1 |
| Tightening torque | 7.08 lbf.in (0.8 N.m) EN/IEC 60947-1 |
| Shape of screw head | Cross slotted |
| Mechanical durability | 5000000 cycles |
| Operating position | Any position |
| [Ie] rated operational current | 3 A 240 V, AC-15, A600-Q600 0.55 A 125 V, DC-13, A600-Q600 |
| [Ui] rated insulation voltage | 250 V 3)EN/IEC 60947-1 |
| [Uimp] rated impulse withstand voltage | 2.5 kV EN/IEC 60947-1 |
| Contacts material | Silver alloy contacts |
| Positive opening | Without |
| Short-circuit protection | 10 A cartridge fuse EN/IEC 60947-5-1 |
| [Ith] conventional free air thermal current | 10 A |
| [Icm] rated short-circuit making capacity | 12 KA 600 V AC-15, 7200 VA 15 KA 480 V AC-15, 7200 VA 30 KA 240 V AC-15, 7200 VA 60 KA 120 V AC-15, 7200 VA 0.1 KA 600 V DC-13 0.27 KA 250 V DC-13 0.55 KA 125 V DC-13 |
| Rated breaking capacity | 3 KA 120 V AC-15, 720 VA 1.2 KA 480 V AC-15, 720 VA 1.2 KA 600 V AC-15, 720 VA 1.5 KA 240 V AC-15, 720 VA 0.55 KA 125 V DC-13 0.27 KA 600 V DC-13 0.55 KA 250 V DC-13 |
| Net Weight | 0.15 lb(US) (0.07 kg) |
| Device presentation | Complete product |

Environment

| | |
|---------------------------------------|--|
| Standards | JIS C 852 JIS C 4520 UL 508 CSA C22.2 No 14 EN/IEC 60947-5-4 EN/IEC 60947-1 EN/IEC 60947-5-1 |
| Product Certifications | NEMA UL 508 |
| Protective treatment | TC |
| Ambient Air Temperature for Storage | -40...158 °F (-40...70 °C) |
| Ambient Air Temperature for Operation | -13...158 °F (-25...70 °C) |
| Vibration resistance | 7 gn 2...500 Hz)IEC 60068-2-6 |
| Shock resistance | 50 gn IEC 60068-2-27 |
| Electrical shock protection class | Class II IEC 61140 |
| IP degree of protection | IP66 IEC 60529 |
| NEMA degree of protection | NEMA 1 NEMA 12 NEMA 13 NEMA 2 NEMA 3 NEMA 3R NEMA 4 NEMA 4X |





Ordering and shipping details

| | |
|-----------------------|---------------------|
| Category | 21429-9001 SK,SKY |
| Discount Schedule | CS1 |
| GTIN | 3389118036796 |
| Nbr. of units in pkg. | 1 |
| Package weight(Lbs) | 8.00 oz (226.796 g) |
| Returnability | No |
| Country of origin | MX |

Packing Units

| | |
|------------------------|------------------|
| Unit Type of Package 1 | PCE |
| Package 1 Height | 2.09 in (5.3 cm) |
| Package 1 width | 2.28 in (5.8 cm) |
| Package 1 Length | 2.99 in (7.6 cm) |

Offer Sustainability

| | |
|----------------------------|---|
| Sustainable offer status | Green Premium product |
| California proposition 65 | WARNING: This product can expose you to chemicals including: Lead and lead compounds, which is known to the State of California to cause cancer and birth defects or other reproductive harm. For more information go to www.P65Warnings.ca.gov |
| REACH Regulation |  REACH Declaration |
| REACH free of SVHC | Yes |
| EU RoHS Directive | Pro-active compliance (Product out of EU RoHS legal scope)  EU RoHS Declaration |
| Toxic heavy metal free | Yes |
| Mercury free | Yes |
| RoHS exemption information |  Yes |
| China RoHS Regulation |  China RoHS Declaration |
| Environmental Disclosure |  Product Environmental Profile |
| WEEE | The product must be disposed on European Union markets following specific waste collection and never end up in rubbish bins. |

Contractual warranty

| | |
|----------|-----------|
| Warranty | 18 months |
|----------|-----------|

Dimensions

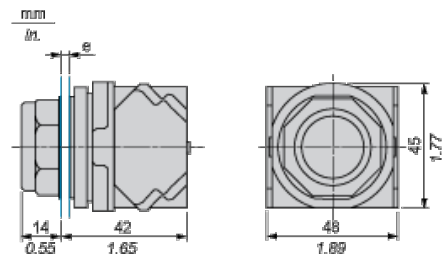

e panel thickness: 1 to 6 mm / 0.04 to 0.24 in.

Contact Block Mounting Position

Top and Rear views

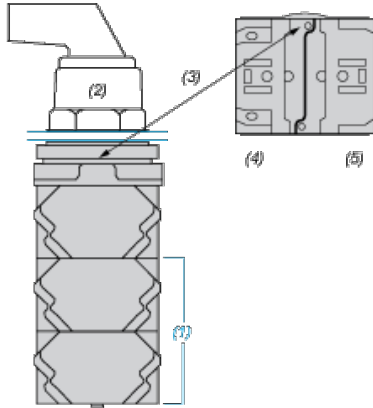

- (1) It is possible to mount up to 3 levels of contacts blocks (maximum of 6 contacts blocks)
- (2) Operator
- (3) Locating notch
- (4) Side 1
- (5) Side 2