

1N4148

SILICON SWITCHING DIODE



www.centrasemi.com

DESCRIPTION:

The CENTRAL SEMICONDUCTOR 1N4148 is a high speed switching diode manufactured in a DO-35 hermetically sealed glass case. The 1N4148 is a drop in replacement for the 1N914.

MARKING: FULL PART NUMBER

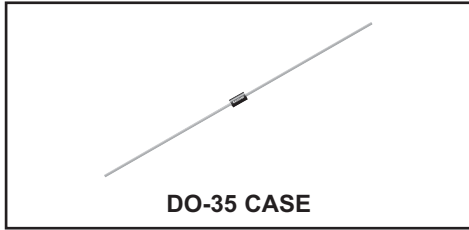

DO-35 CASE

MAXIMUM RATINGS: ($T_A=25^\circ\text{C}$)

Peak Repetitive Reverse Voltage
Peak Working Reverse Voltage
Average Forward Current
DC Forward Current
Peak Forward Surge Current, $t_p=1.0\mu\text{s}$
Power Dissipation
Operating and Storage Junction Temperature

SYMBOL

V_{RRM} 100
 V_{RWM} 75
 I_O 150
 I_F 200
 I_{FSM} 2.0
 P_D 500
 T_J, T_{stg} -65 to +200

UNITS

V
V
mA
mA
A
mW
 $^\circ\text{C}$

ELECTRICAL CHARACTERISTICS: ($T_A=25^\circ\text{C}$ unless otherwise noted)

SYMBOL	TEST CONDITIONS	MIN	MAX	UNITS
I_R	$V_R=20\text{V}$		25	nA
BV_R	$I_R=1.0\text{mA}$	100		V
BV_R	$I_R=100\mu\text{A}$	75		V
V_F	$I_F=10\text{mA}$		1.0	V
C_J	$V_R=0, f=1.0\text{MHz}$		4.0	pF
t_{rr}	$V_R=6.0\text{V}, I_F=10\text{mA}, I_{rr}=1.0\text{mA}, R_L=100\Omega$		4.0	ns

1N4148
SILICON SWITCHING DIODE



DO-35 CASE - MECHANICAL OUTLINE

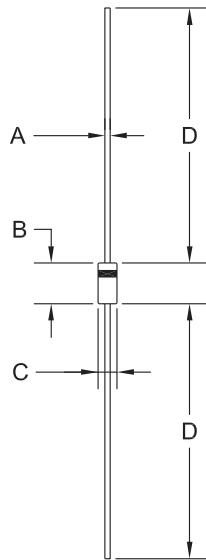

SYMBOL	INCHES		MILLIMETERS	
	MIN	MAX	MIN	MAX
A	0.018	0.022	0.46	0.56
B	0.120	0.200	3.05	5.08
C	0.060	0.090	1.52	2.29
D	1.000	-	25.40	-

DO-35 (REV: R1)

R1

R1 (23-November 2015)

1N4148

SILICON SWITCHING DIODE



TYPICAL ELECTRICAL CHARACTERISTICS

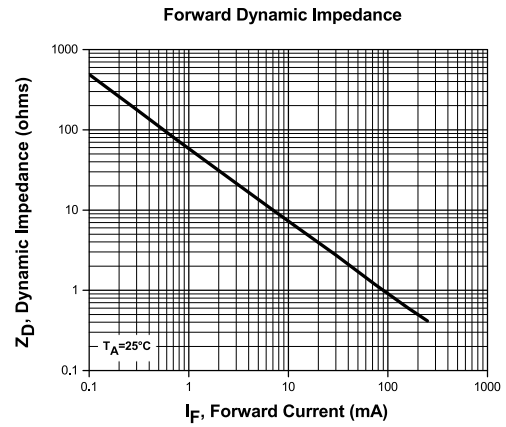
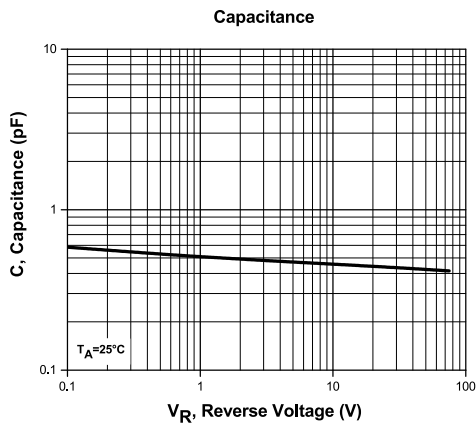
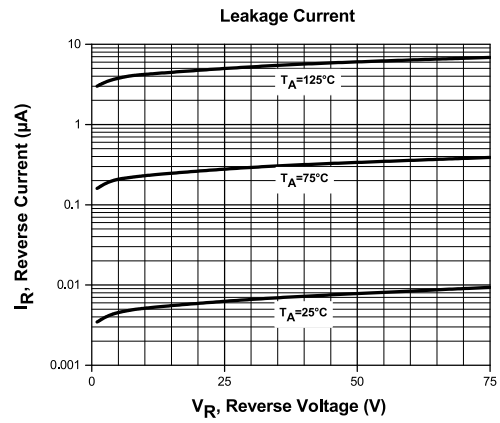
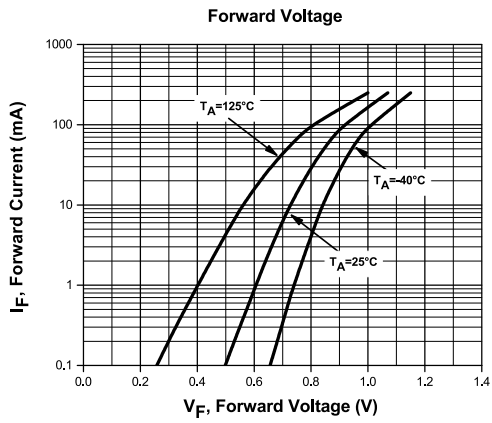

R1 (23-November 2015)

1N4148
SILICON SWITCHING DIODE



TYPICAL ELECTRICAL CHARACTERISTICS

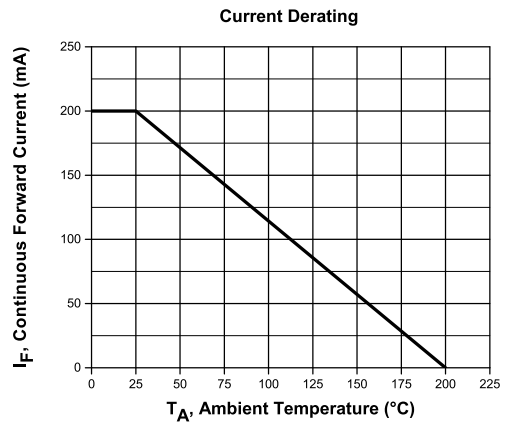
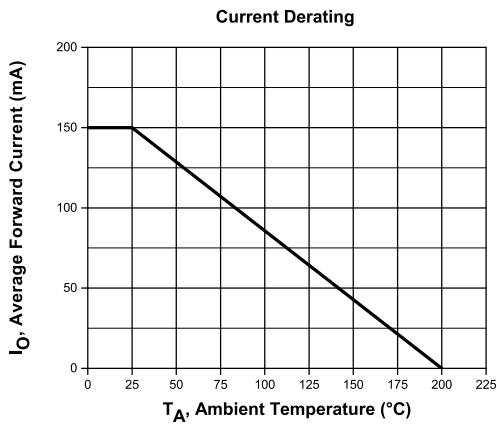
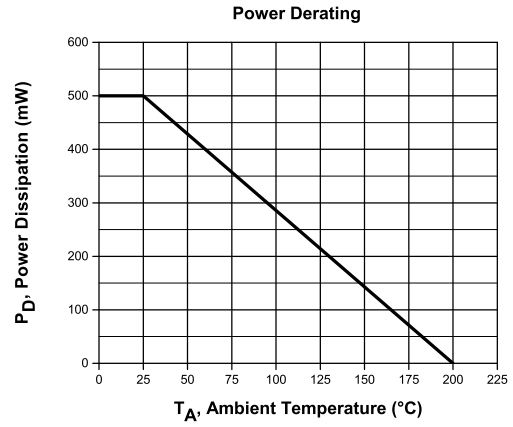
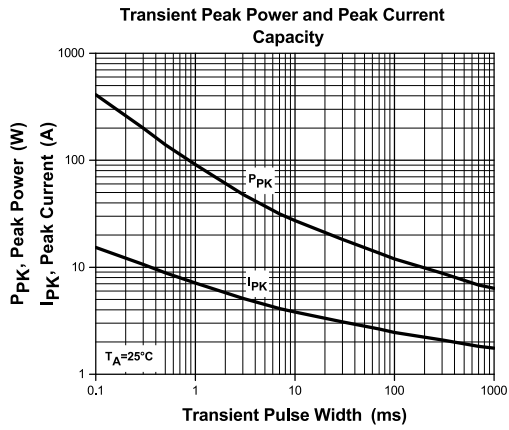

R1 (23-November 2015)

OUTSTANDING SUPPORT AND SUPERIOR SERVICES



PRODUCT SUPPORT

Central's operations team provides the highest level of support to insure product is delivered on-time.

- Supply management (Customer portals)
- Inventory bonding
- Consolidated shipping options
- Custom bar coding for shipments
- Custom product packing

DESIGNER SUPPORT/SERVICES

Central's applications engineering team is ready to discuss your design challenges. Just ask.

- Free quick ship samples (2nd day air)
- Online technical data and parametric search
- SPICE models
- Custom electrical curves
- Environmental regulation compliance
- Customer specific screening
- Up-screening capabilities
- Special wafer diffusions
- PbSn plating options
- Package details
- Application notes
- Application and design sample kits
- Custom product and package development

CONTACT US

Corporate Headquarters & Customer Support Team

Central Semiconductor Corp.
145 Adams Avenue
Hauppauge, NY 11788 USA
Main Tel: (631) 435-1110
Main Fax: (631) 435-1824
Support Team Fax: (631) 435-3388
www.centrasemi.com

Worldwide Field Representatives:
www.centrasemi.com/wwreps

Worldwide Distributors:
www.centrasemi.com/wwdistributors

For the latest version of Central Semiconductor's **LIMITATIONS AND DAMAGES DISCLAIMER**, which is part of Central's Standard Terms and Conditions of sale, visit: www.centrasemi.com/terms