

**SERIES 42, 43, 44 and 54**  
**1" Diameter, 1 Amp, Standard,**  
**Military SR04**

**FEATURES**

- Rugged Construction Ensures Switch Operation for the Life of Your Equipment
- Many Circuitry Options
- MIL Qualified Versions MIL-S-3786/04
- Features Choice Include: Shaft/ Panel Seal, Adjustable Stops, PC Termination, UL Recognized



**DIMENSIONS** in inches (and millimeters)

**Standard, UL Recognized and Military Qualified Solder Lug Styles**

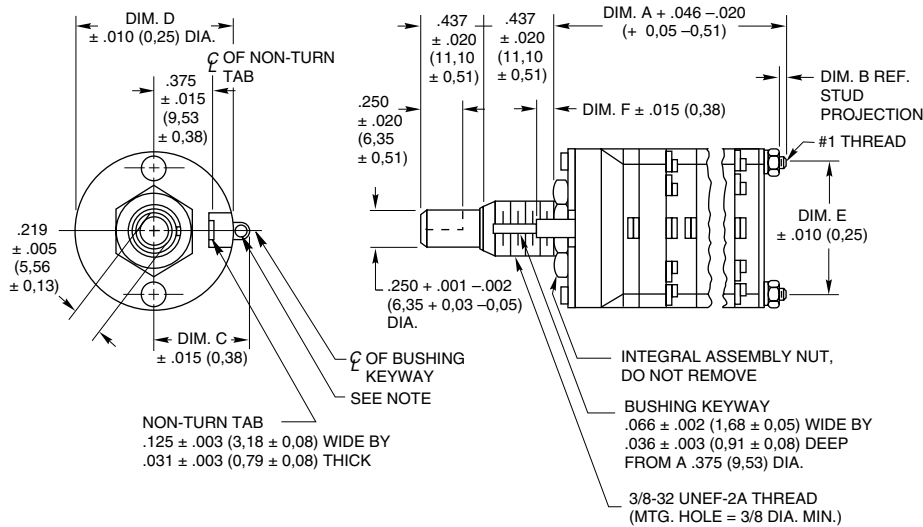

**Note:** Common location for a single pole per deck switch. For common location on multi-pole switches, see circuit diagrams.

**Rear Views**

**Series 42**

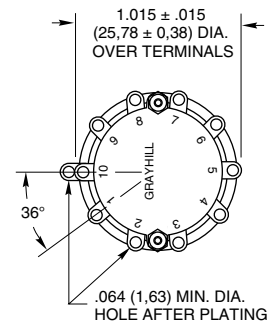

**Series 44**

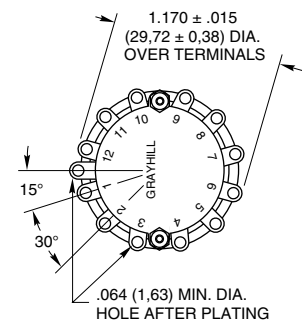

For rear view of 45°, 60° and 90°, see circuit diagram.

| No. of Decks | Dimension A   | Dimension B |              | Approx. Weight Grams |    | No. of Decks | Dimension A    | Dimension B |              | Approx. Weight Grams |     |
|--------------|---------------|-------------|--------------|----------------------|----|--------------|----------------|-------------|--------------|----------------------|-----|
|              |               | Style A     | Style M or H | 42                   | 44 |              |                | Style A     | Style M or H | 42                   | 44  |
| 1            | 1.025 (26,04) | .062 (1,57) | .030 (0,76)  | 40.0                 | 48 | 7            | 3.351 (85,16)  | .312 (7,92) | .280 (7,11)  | 73.0                 | 90  |
| 2            | 1.371 (34,82) | .062 (1,57) | .030 (0,76)  | 45.5                 | 55 | 8            | 3.697 (93,90)  | .312 (7,92) | .280 (7,11)  | 78.5                 | 97  |
| 3            | 1.717 (43,61) | .062 (1,57) | .030 (0,76)  | 51.0                 | 62 | 9            | 4.043 (102,69) | .312 (7,92) | .280 (7,11)  | 84.0                 | 104 |
| 4            | 2.063 (52,40) | .062 (1,57) | .030 (0,76)  | 56.5                 | 69 | 10           | 4.389 (111,48) | .312 (7,92) | .280 (7,11)  | 89.5                 | 111 |
| 5            | 2.409 (61,19) | .062 (1,57) | .030 (0,76)  | 62.0                 | 76 | 11           | 4.735 (120,27) | .312 (7,92) | .280 (7,11)  | 95.0                 | 118 |
| 6            | 3.005 (76,33) | .312 (7,92) | .280 (7,11)  | 67.5                 | 83 | 12           | 5.081 (129,06) | .312 (7,92) | .280 (7,11)  | 100.5                | 125 |

Grayhill part number and date code marked on detent cover label. Customer part number marked on request. Military part number marked when required. UL recognized markings as required.

| Dimension | C            | D             | E            | F           |
|-----------|--------------|---------------|--------------|-------------|
| Series 42 | .562 (14,27) | 1.000 (25,4)  | .830 (21,08) | .093 (2,36) |
| Series 44 | .642 (16,31) | 1.162 (29,51) | 1.000 (25,4) | .121 (3,07) |

CIRCUIT DIAGRAMS: Solder Lug Terminals

Switch is Viewed From Shaft End and Shown in Position No. 1

Note: All common terminals are located above base terminals as shown.

Series 44 & 54  
30° Angle of Throw

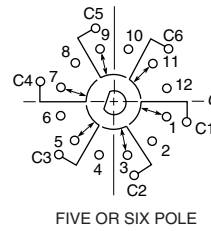
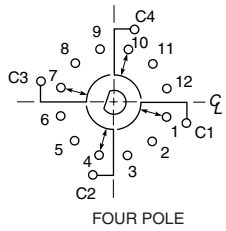
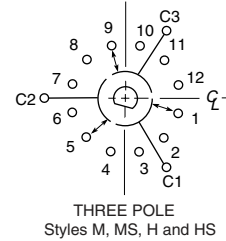
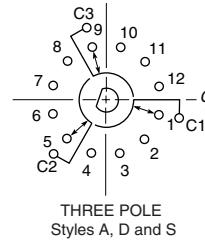
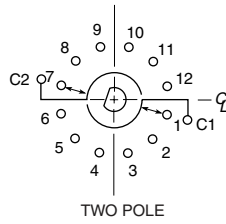
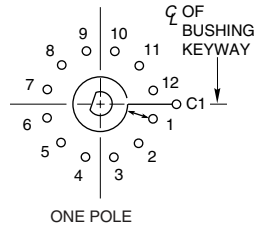

Series 42 & 43  
36° Angle of Throw

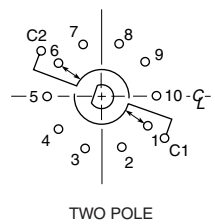
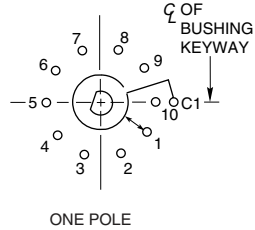

Series 44  
45° Angle of Throw

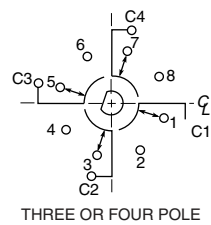
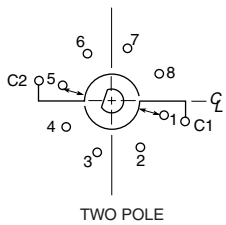
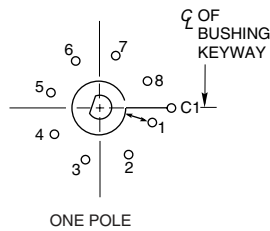

Series 44  
60° Angle of Throw

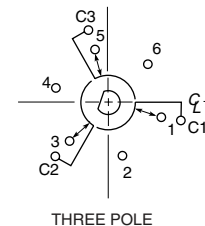
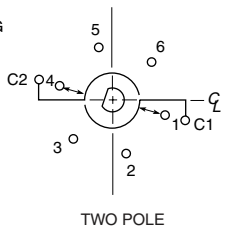
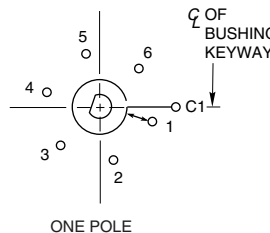

Series 44  
90° Angle of Throw

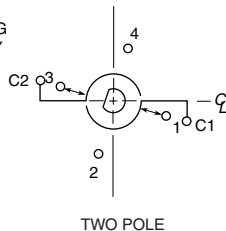
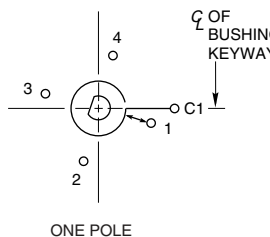

Rear Views

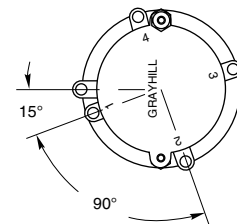
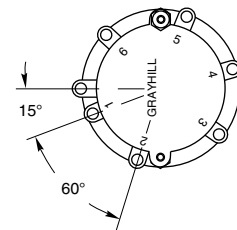
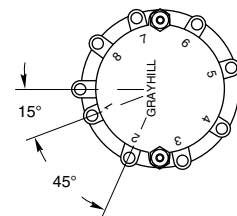

Rotary Switches

## Recommended Panel Cutout

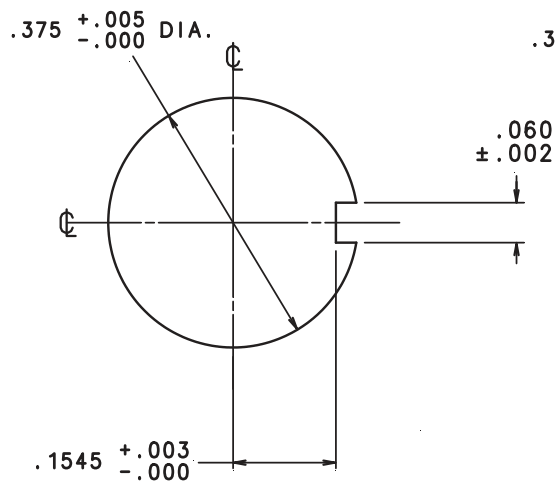
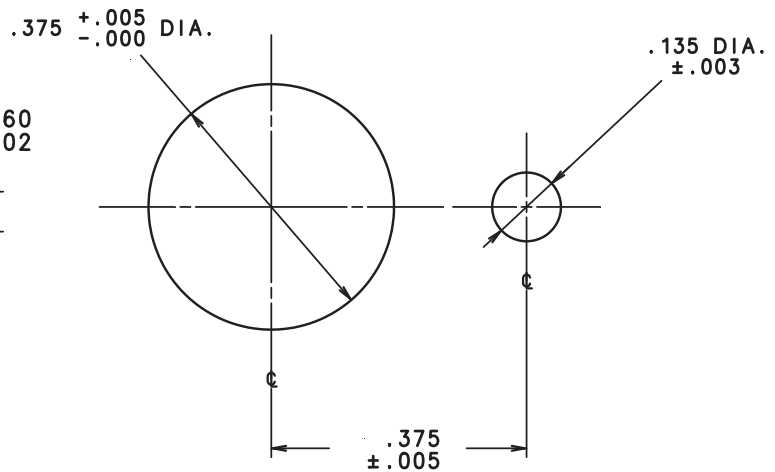
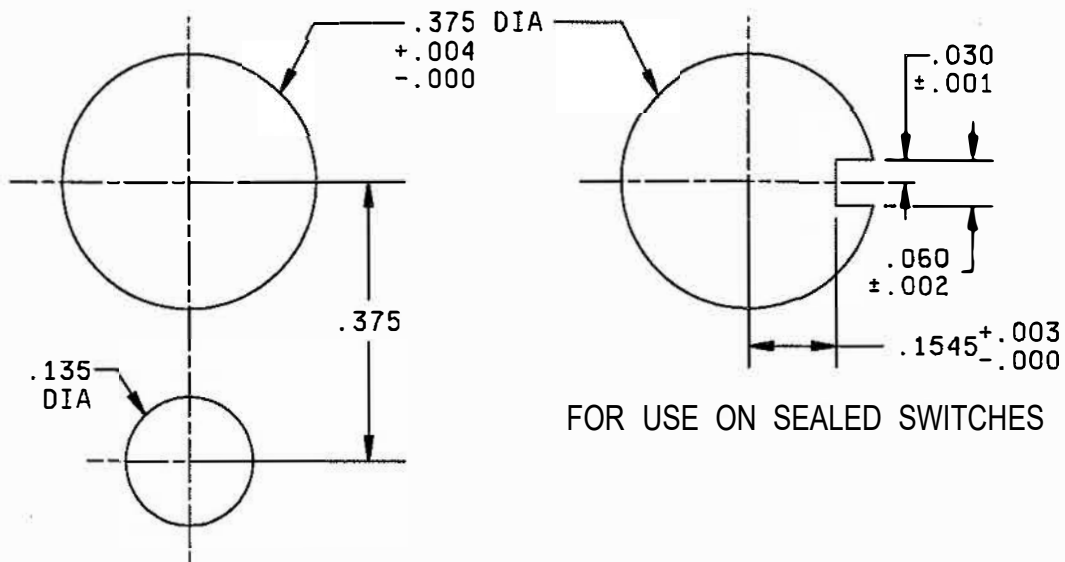
**For all 42/43/44/54 Series  
Sealed Version  
(Including 42P Style)**

**For all 42/43/44/54 Series  
Non-Sealed Version  
(Except 42P Style)**

**MIL-DTL-3786/4L**

FOR USE WITH NON-TURN DEVICES

FOR USE ON SEALED SWITCHES

**NOTES:**

1. Dimensions are in inches.
2. Metric equivalents are given for general information only.
3. Unless otherwise specified, tolerances are  $\pm 0.003$  (0.08 mm) on diameters,  $\pm 0.005$  (0.13 mm) on all other dimensions, and  $\pm 2^\circ$  on angles.

## SERIES 42

1" Diameter, 1 Amp, PC Mount

### FEATURES

- Satisfies High Current Board Level Applications
- 36° Angle of Throw Permits up to Ten Positions
- UL Recognized Versions



### DIMENSIONS in inches (and millimeters)

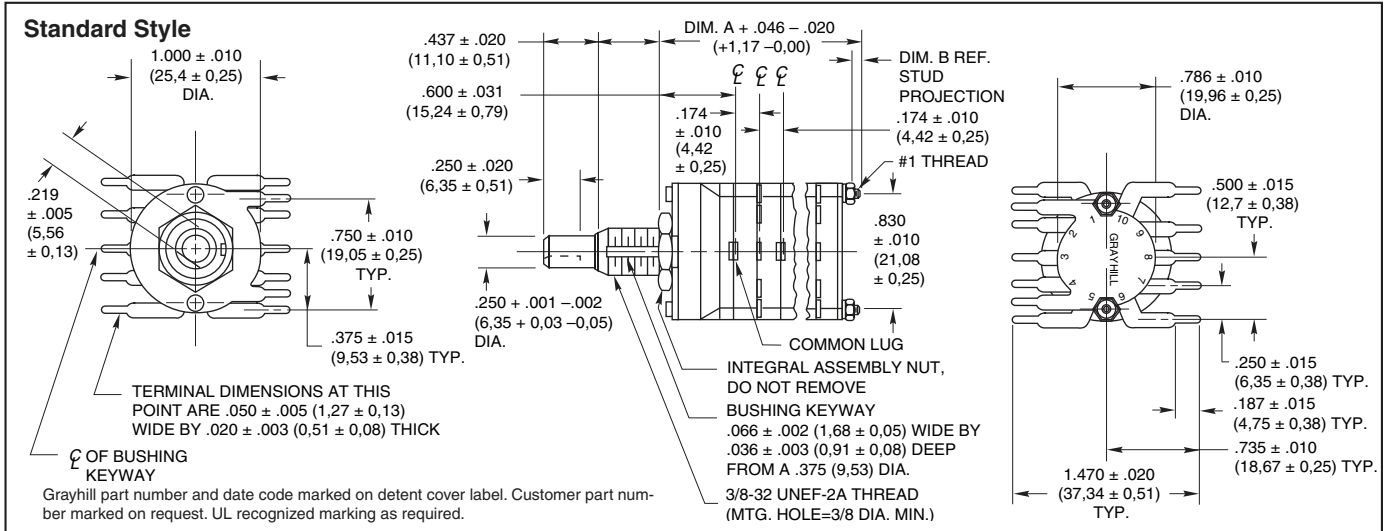

### CIRCUIT DIAGRAM: PC Mount

#### Switch is Viewed From Shaft End and Shown in Position No. 1

Note: All common terminals are located above base terminals as shown.

#### Termination

One-sided termination is standard for switches with 2 to 5 positions per pole. Two-sided termination is standard for switches with 6 thru 10 positions per pole.

6 thru 10 positions per pole and terminals from one side of switch are available on special order. See Special Options, page F-10 or contact Grayhill.

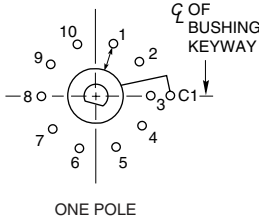

### PC BOARD MOUNTING PATTERN

Shown for a two deck switch

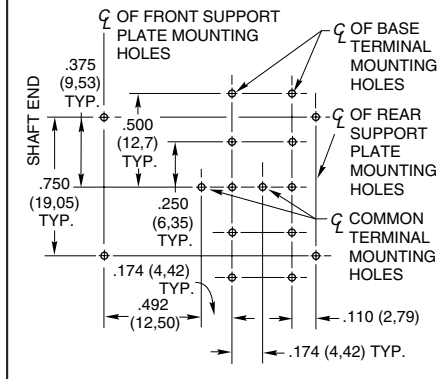

### SHAFT AND PANEL SEAL: Srs. 42 & 44

#### Standard Style

The Series 42/44 Styles, which include the letter "S" with the exception of style "HS", are watertight sealed to the mounting panel by utilizing the panel seal kit. These switches are built with a front plate that does not have a non-turn tab. The panel seal kit consists of a grooved hex nut, a keyed washer and a keyed panel seal. The grooved hex nut is assembled to the switch bushing. The keyed washer is slid down the bushing slot and seated into the hex nut groove. The seal is likewise assembled to the bushing and hex nut. The keyed washer is required to provide seal integrity in the bushing slot. When assembled to the panel, the grooved nut, backing washer and seal require the same space as a normal mounting nut. Hence, the seal kit does not alter the dimensions. Panel seal kit includes a non-turn washer to be used into a blind hole in the back panel. For panel seal kit part dimensions, see Accessories. Style "HS" switches use a similar sealing method, except the integral assembly nut retains the panel seal. All sealed style switches are provided with a shaft to bushing internal seal.

### ADJUSTABLE STOP SWITCHES: Series 42 and 44

The standard and UL recognized switches are also available with adjustable stops. Two removable stop washers allow you to limit the number of switch positions as needed. A knurled nut is supplied to secure the washers if desired.

These switches have no bushing keyway. All other dimensions, ratings and characteristics are the same as the standard fixed stop styles. Although not military qualified, the adjustable styles are useful in military equipment prototypes. However, when submitting the equipment for government approval, the fixed stop qualified style should be substituted.

#### Equivalent Styles

For style 42A36, use 42D36,  
For style 44A30, use 44D30  
For style 42M36, use 42D36 initially

For style 44M30, use 44D30 initially  
For style 42U36, use 42UD36  
For style 44U30, use 44UD30

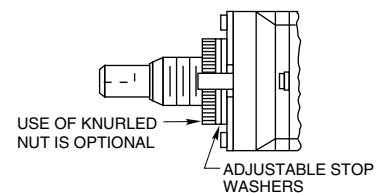
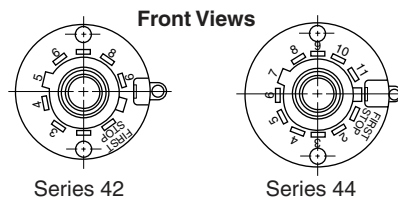

**SERIES 43**  
**SERIES 54**  
**1" Diameter, 1 Amp, Concentric**  
**Shafts**

**FEATURES**

- Two Switches in the Panel Space of a Single Shaft Rotary
- Military Qualified Versions MIL-3786/04
- Choice of 10 Positions (Series 43) or 12 Positions (Series 54)



**DIMENSIONS** in inches (and millimeters)

**Standard Style and Military Qualified**

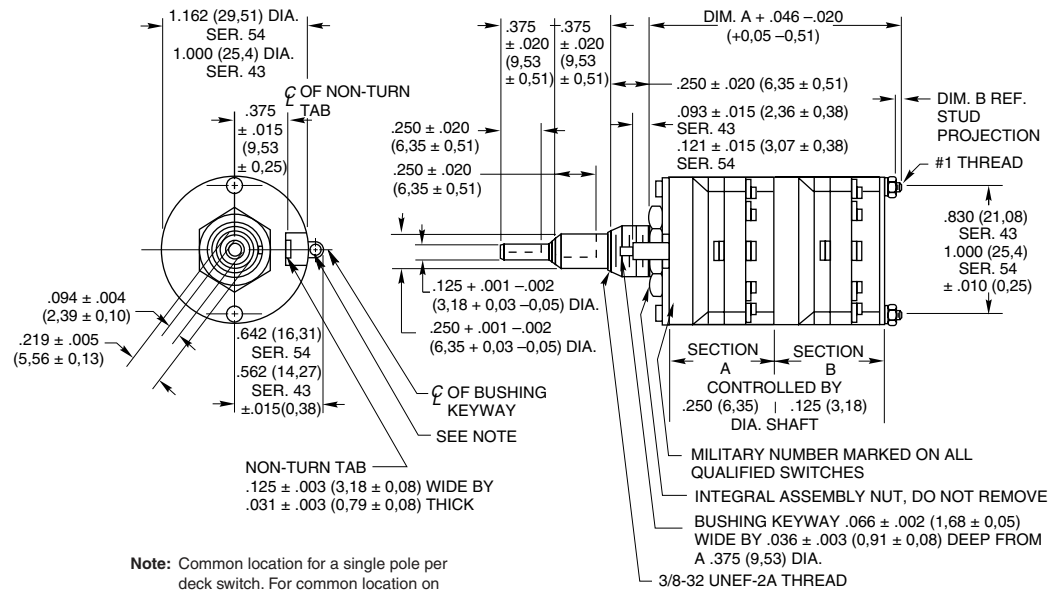

**Note:** Common location for a single pole per deck switch. For common location on multi-pole switches, see circuit diagrams.

**Rear Views**

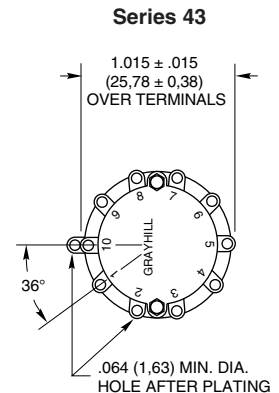

**Series 54**

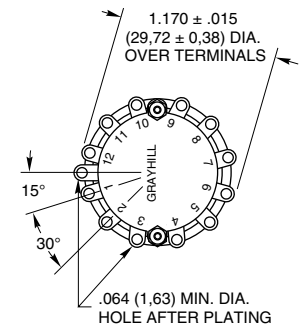

| Number of Decks |             | Dimension A   | Dimension B |              | Approx. Weight Grams |           |
|-----------------|-------------|---------------|-------------|--------------|----------------------|-----------|
| Section "A"     | Section "B" |               | Style A     | Style M or H | Series 43            | Series 54 |
| 1               | 1           | 1.818 (46,18) | .062 (1,57) | .030 (0,76)  | 48                   | 60        |
| 2               | 1           | 2.164 (54,97) | .062 (1,57) | .030 (0,76)  | 54                   | 67        |
| 3               | 1           | 2.510 (63,75) | .062 (1,57) | .280 (7,11)  | 60                   | 74        |
| 1               | 2           | 2.164 (54,97) | .062 (1,57) | .030 (0,76)  | 54                   | 67        |
| 2               | 2           | 2.510 (63,75) | .062 (1,57) | .280 (7,11)  | 60                   | 74        |
| 3               | 2           | 3.105 (78,87) | .312 (7,92) | .280 (7,11)  | 66                   | 81        |
| 1               | 3           | 2.510 (63,75) | .062 (1,57) | .280 (7,11)  | 60                   | 74        |
| 2               | 3           | 3.105 (78,87) | .312 (7,92) | .280 (7,11)  | 66                   | 81        |
| 3               | 3           | 3.451 (87,66) | .312 (7,92) | .280 (7,11)  | 72                   | 88        |

Grayhill part number and date code marked on detent cover label. Customer part number marked on request. Military part number marked when required.

## SERIES 43 and 54

1" Diameter, 1 Amp, Add-A-Pot

### FEATURES

- Central Shaft Designed to Operate an Add-On Potentiometer
- Potentiometer Mounting Plates Provided
- Adjustable Stop Standard, Fixed Stop by Order
- Choice of 10 Positions (Series 43) or 12 Positions (Series 54)



### DIMENSIONS In inches (and millimeters)

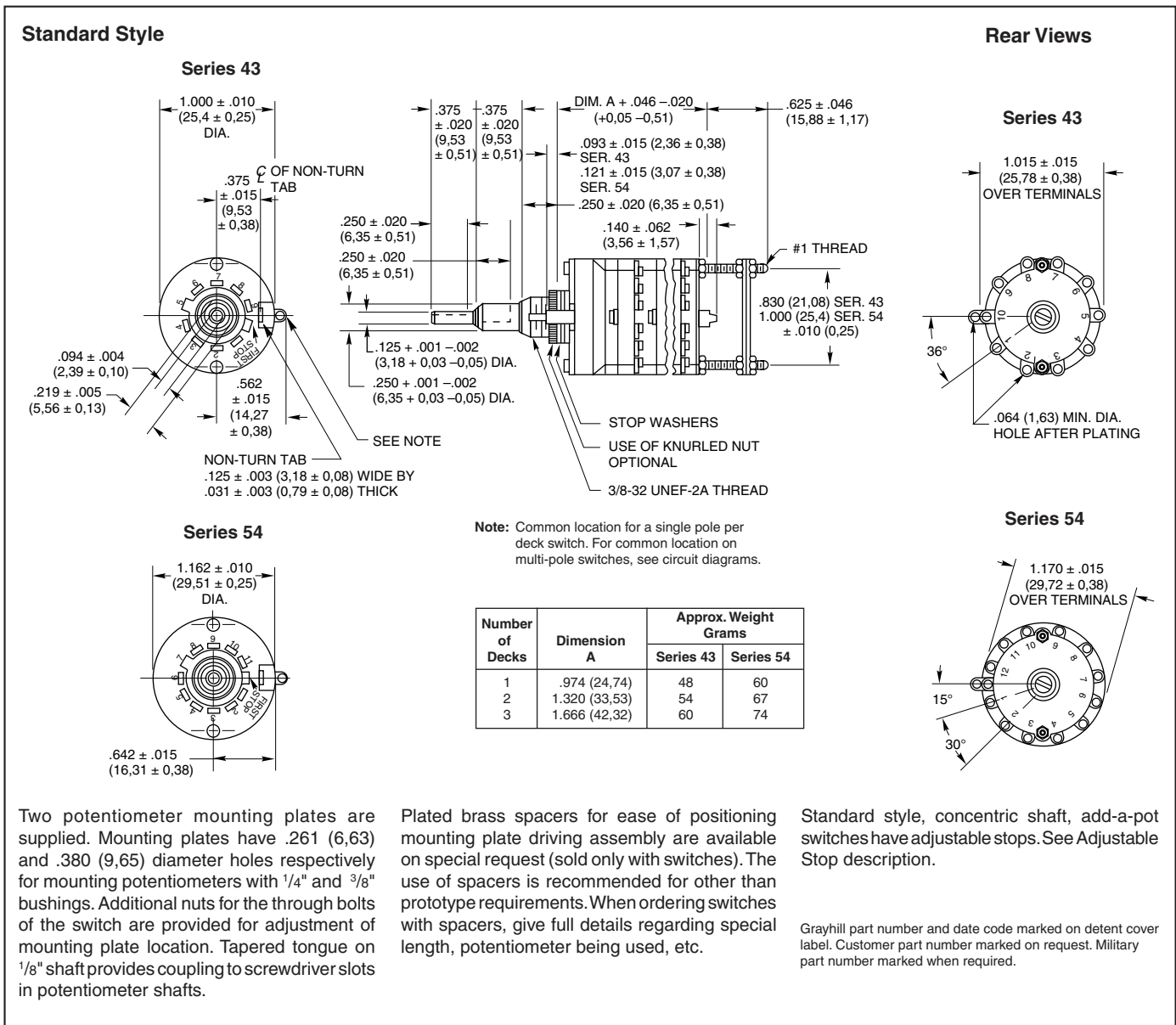



## SERIES 54

### 1" Diameter, 1 Amp, Add-A-Pot

#### FEATURES

- Military Qualified MIL-3786/04
- Central Shaft Designed to Operate MIL Potentiometer
- Mounting Plate Options Provide Choice of Potentiometer
- Fixed Distance from Switch to Mounting Plate



#### DIMENSIONS In inches (and millimeters)

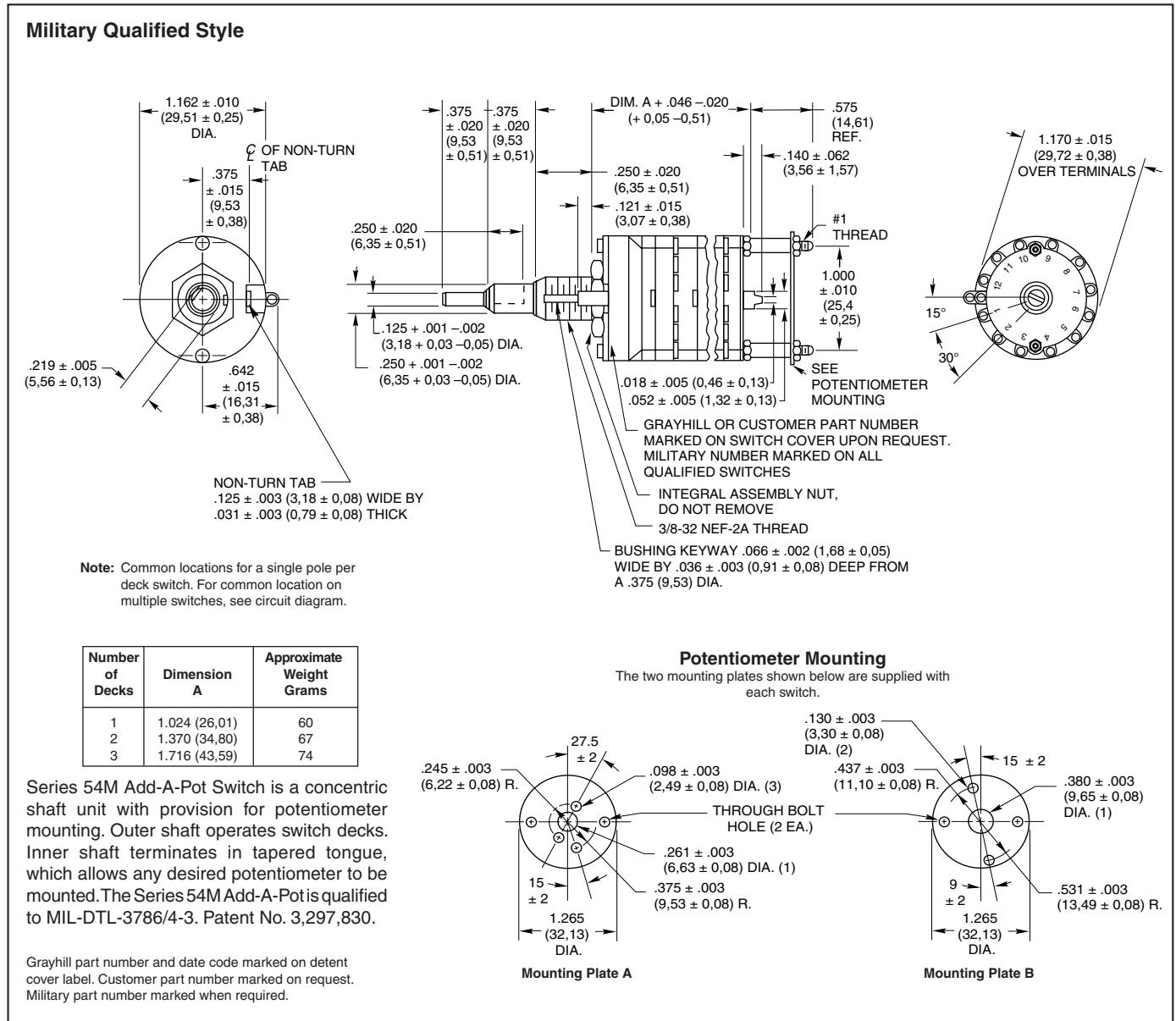

Rotary Switches

## MILITARY QUALIFIED

### Single Shaft Switches

The military styles of the single shaft Series 42 and 44 rotary switches are qualified to MIL-DTL-3786/4, specifically SR04-1. Qualification includes two temperature ranges. Unsealed styles M, MB, MG and MBG are qualified for -65 to 85°C. Unsealed styles H, HB, HG and HBG, plus sealed styles HS, HBS, HGS and HBGS are qualified for -65°C to 125°C. Qualification includes low level switching and shaft grounding as specified in MIL-DTL-3786. Qualification includes 30°, 36°, 45°, 60° and 90° angles of throw with solder lug terminals. The military styles are dimensionally the same as the standard styles with two exceptions. The location of the common for the 3-pole switch differs (see circuit diagrams) and the non-turn tab for styles HS, HBS, HGS and HBGS differs per the Shaft and Panel Seal description following.

### Two Switches, Concentric Shafts

The M style of the concentric shaft Series 43 and 54 switches is qualified to MIL-DTL-3786/4,

specifically SR04-2. Unsealed switches are qualified for -65°C to 85°C in 30°, 36°, 45°, 60° and 90° throws. The standard and military styles of the concentric switches have the same dimensions with the exception of the location of the 3 pole common (see circuit diagrams). The 30° and 36° throws are described in the ordering information. If the 45°, 60° and 90° throws are required, they can be provided in Section A of the Series 54 Rotary Switches; see Standard Options, page J-9.

### Add-A-Pot Switches

The military style of the add-a-pot Series 54 switch is qualified to MIL-DTL-3786/4, specifically SR04-3. These unsealed switches are qualified for -65°C to 85°C in 30°, 45°, 60° and 90° throws. The dimensions of the military style add-a-pot switches are not the same as the standard add-a-pot switches; see drawings.

### All Qualified Switches

Complete electrical ratings and characteristics for all of these qualified switches are listed on

the following pages. Standard variations such as terminals, shaft and/or bushing length etc., which do not affect performance, can be marked as qualified product. Adjustable stops cannot be qualified. Contact Grayhill for details about variations.

Military qualified switches may be ordered by the military M number listed in MIL-DTL-3786/4 or by the Grayhill part number. They will be marked to specifications.

## MILITARY QUALIFIED SHAFT AND PANEL SEAL:

### Styles HS, HBS, HGS and HBGS

The shaft is sealed to the bushing by an internal O-ring per MIL-P-5516B. The bushing is sealed to the panel with a silicone rubber washer and a stainless steel backing washer. The combined uncompressed thickness is 0.055" (1,40). Since this switch has a flat cover, a non-turn washer is supplied (see Panel Seal Kit). If using it, mount it in front of the panel.

## SPECIFICATIONS:

### Electrical Ratings

#### Standard Style

**Rated:** To make and break the following loads:

|                    | Angle of Throw |            |        |
|--------------------|----------------|------------|--------|
|                    | 30° or 36°     | 45° or 60° | 90°    |
| 115 Vac resistive  | 1 amp          | 5 amps     | 5 amps |
| 6-28 Vdc resistive | 1 amp          | 1 amp      | 2 amps |
| 115 Vac inductive  | 0.25 amp       | 2 amps     | 2 amps |
| 115 Vdc inductive  | 0.02 amp       | —          | —      |
| 6-28 Vdc inductive | 0.10 amp       | —          | —      |
| 115 Vdc resistive  | 0.10 amp       | —          | —      |

To carry 10 amps continuously.

**Contact Resistance:** 50 milliohms maximum

**Insulation Resistance:** 1,000 megaohms minimum

**Voltage Breakdown:** 1,000 Vac initially (500 Vac or better after most environmental tests)

**Life Expectancy:** 100,000 mechanical cycles of operation. *Note:* Actual life is determined by a number of factors, including electrical loading, rate of rotation and environment, as well as maximum voltage breakdown required at the end of life.

### UL Recognition—

#### Styles UA, UD, UM, UP, US and USP

Grayhill styles A and M and their variations (D, P, S and SP) of the Series 42, 43, 44 and 54 rotary switches have been tested by Underwriters Laboratories. The letter U in the style indicates proper marking as required by Underwriters Laboratories. These switches are recognized under file number E35289. The UL rating for the Series 42, 43, 44 and 54 is as follows:

**Electrical Parameters:** style UA = 1.0 ampere at 125 Vac. Style UM = 1.0 ampere at 125 Vac and also .5 ampere at 125 Vac, inductive load, 0.75 to 0.8 power factor.

Rating based on the following criteria:

**Overload:** 50 operations at 150% rated AC load

**Endurance:** 6000 operations at the rated load with 1000 Vac dielectric strength before and after test

**Temperature Rise:** Not to exceed 30°C when carrying rated AC load after test.

*Note:* all dimensional drawings for the standard style Series 42, 43, 44 and 54 also apply to these switches, with the exception that switches are marked per specifications.

### Electrical Ratings

#### Military Style

**General Rating:** This rating is based on standard Grayhill tests of the Military style switch done at ambient conditions. It is provided for comparison to the Standard Style switch.

Charts shown for non-shorting contacts (break before make)

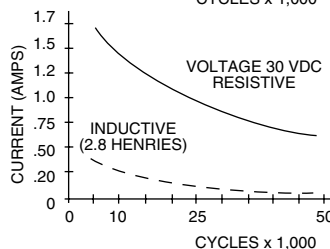
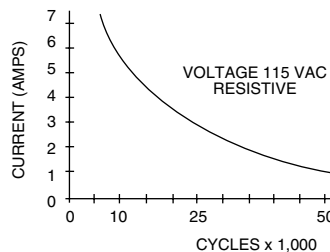

**Voltage and Load:** As listed in the chart One cycle is 360° rotation and a return through all switch positions to the starting position. The data for the curves was measured at sea level, 25°C and 68% relative humidity.

The Series 42, 43, 44 and 54, style M, H and HS switches are made to meet requirements of MIL-DTL-3786, style SR04. Diallyl phthalate molded parts and the design of internal switching elements provide exceptional performance.

Curves shown are typical load-life curves for Series 42, 43, 44 and 54, style M, H and HS switches with 30° or 36° angles of throw. They show the numbers of cycles of rotational life expectancy for the types of loads shown. Thus, with a 5 amp, 115 Vac resistive load, 10,000 cycles of life is expected. If the load is reduced to 3 amps, life is increased to 25,000 cycles. The larger angles of throw (45°, 60° or 90°) switch larger currents for a like number of cycles.

Life limiting or failure criteria for these curves are:

**Contact Resistance:** 50 milliohms maximum

**Insulation Resistance:** 1,000 megaohms minimum between mutually insulated parts

**Voltage Breakdown:** 1,000 Vac minimum between mutually insulated parts. These switches will carry 10 amps with maximum contact temperature rise of 20°C. Life can be predicted by Grayhill if less critical life characteristics, elevated temperature or reduced pressure is involved.

## MIL-S-3786 Electrical Values Military Style



## SPECIFICATIONS:

Style M switches, at 85°C, approximately 68% humidity and sea level pressure and style H and HS at 125°C have been tested to make and break the following loads as stated in MIL-DTL-3786/SR04; 250 milliamperes at 28 Vdc resistive, 100 milliamperes at 28 Vdc inductive (2.8 henries); 75 milliamperes at 115 Vac resistive.

These switches have also been tested at reduced barometric pressure (70,000 feet), 25°C at approximately 68% relative humidity to make and break the following loads as stated in MIL-DTL-3786/SR04; 200 milliamperes, 28 Vdc resistive; 25 milliamperes, 28 Vdc inductive (2.8 henries); 20 milliamperes, 115 Vac resistive. When tested to these loads and conditions the style M, H and HS switches meet the following life limiting or failure criteria after 25,000 cycles in accordance with MIL-S-3786.

**Contact Resistance:** 50 milliohms maximum

**Insulation Resistance:** 1,000 megaohms minimum between terminals and shafts

**Dielectric Strength:** 1,000 Vac (atmospheric pressure) and 450 Vac (reduced pressure) minimum between mutually insulated parts.

When tested at sea level 25°C and 68% relative humidity with failure criteria of 50 milliohms max. and 750 Vac breakdown voltage, these switches will make and break the following loads: 250 mA at 28Vdc, inductive (2.8 henries); 1.25 amps at 28Vdc resistive; 2.0 amps at 115 Vac, 60 Hz resistive, for 10,000 cycles.

These switches also meet MIL-DTL-3786/SR04 for moisture resistance, medium and high shock, vibration (10 to 2000 cps), thermal shock (-65°C to 125°C), salt spray, explosion and terminal pull.

### Materials and Finishes

#### Standard Style

**Bases:** Melamine per (MIL-M-14) ASTM-D-5948

**Cover, Deck Separators, End Plate and Rotor Mounting Plate:** Phenolic per (MIL-M-14) ASTM-D-5948

**Mounting Bushings:** Brass, tin/zinc-plated.  
**Shaft, Cover Plate, Retaining Rings, Through Bolts, Shaft Extensions, Stop Arm, Thrust Washers Stop Washers and Rear Support Plate:** Stainless Steel

**Detent Balls:** Steel, nickel-plated

**Detent Springs:** Tinned music wire

**Rotor Contact, Stator (Base) Contacts:** Silver alloy

**Terminals (Except Common):** Brass, tin plated

**Common Plate, Including Solder Lug:** Brass, silver-plated .0003" minimum

**Mounting Hardware:** Two mounting nuts .094" (2,39) thick by .562" (14,27) across flats and one internal tooth lockwasher are supplied with each switch.

**Stud Nuts, Mounting Nuts, Lock Washers:** Tin/zinc-plated or stainless steel.

### Materials and Finishes

#### Military Qualified

**Bases:** Diallyl per (MIL-M-14) ASTM-D-5948

**Cover, Deck Separators, End Plate and Rotor Mounting Plate:** Diallyl per (MIL-M-14) ASTM-D-5948

**Mounting Bushings:** Brass, tin/zinc-plated.  
**Shaft, Cover Plate, Retaining Rings, Through Bolts, Shaft Extensions, Stop Arm, Stop Washers, Thrust Washers and Rear Support Plate:** Stainless steel

**Detent Balls:** Steel, nickel-plated

**Detent Springs:** Tinned music wire

**Rotor Contact:** Silver alloy

**Terminals, Common Plate including Solder Lug:** Brass, silver-plated .0003" minimum

**Mounting Hardware:** Two mounting nuts .094" thick by .562" across flats and one internal tooth lockwasher are supplied with each switch.

**Stud Nuts, Mounting Nuts, Lock Washers:** Tin/zinc-plated or stainless steel.

### Additional Characteristics

#### Standard Style and Military Qualified

**Contact:** Shorting or non-shorting wiping contacts with over 150 grams of contact force

**Rotational Torque:** 8-115 ounce-inches depending upon the number of poles per deck, number of decks and angle of throw

**Mechanical Life Expectancy:** 100,000 cycles of operation

**Shaft Flat Orientation:** Flat opposite contacting position of pole number one (See circuit diagram).

**Stop Strength:** For Standard style: 15 pound-inches minimum. For Adjustable stop styles: 12 pound-inches

**Extended Stud:** Single shaft switches of six or more decks and concentric shaft switches of a combination of five or more decks (Standard style) or four or more decks (Military style) have longer studs with extra mounting nuts for recommended double end mount.



**CHOICES AND LIMITATIONS: Series 42, 43, 44 and 54**

A = Standard, Solder Lugs  
 P = Standard, PC Mount Terminals  
 D = Standard, Adjustable Stops

S = Shaft and Panel Seal  
 U = UL Recognized  
 M = Military Qualified 85°C<sup>4</sup>

H = Military Qualified, 125°C  
 B = Military, Grounded Shaft  
 G = Military, Low Level Rating

**SINGLE SHAFT SWITCHES**

| Series | Style Choices  |  | Angle of Throw | Number of Decks | Poles Per Deck | Positions Per Pole <sup>1,3</sup> | Shorting or Non-Shorting |   |                         |        |
|--------|--|--|----------------|-----------------|----------------|-----------------------------------|--------------------------|---|-------------------------|--------|
|        | Unsealed   | Shaft/Panel Seal   |                |                 |                |                                   |                          |   |                         |        |
| 42     | A<br>UA<br>UM <sup>5</sup><br>M<br>MB<br>MG<br>MBG<br>H<br>HB<br>HG<br>HBG | S<br>US<br>—<br>MS <sup>4</sup><br>MBS <sup>4</sup><br>MGS <sup>4</sup><br>MBGS <sup>4</sup><br>HS<br>HBS<br>HGS<br>HBGS | 36°            | 01 thru 12      | 1              | 02 thru 10 <sup>3</sup>           | N or S                   |   |                         |        |
|        |  |  |                | 01 thru 12      | 2              | 02 thru 05                        | N or S                   |   |                         |        |
|        |  |  | 44             |                 |                | 30°                               | 01 thru 12               | 1 | 02 thru 12 <sup>3</sup> | N or S |
|        |  |  |                |                 |                |                                   | 01 thru 12               | 2 | 02 thru 06              | N or S |
|        |  |  |                |                 |                |                                   | 01 thru 08               | 3 | 02 thru 04              | N or S |
|        |  |  |                |                 |                | 45°                               | 01 thru 06               | 4 | 02 or 03                | N or S |
|        |  |  |                |                 |                |                                   | 01 thru 04               | 5 | 02                      | N or S |
|        |  |  |                |                 |                |                                   | 01 thru 04               | 6 | 02                      | N or S |
|        |  |  | 44             |                 |                | 45°                               | 01 thru 12               | 1 | 02 thru 08 <sup>3</sup> | N or S |
|        |  |  |                |                 |                |                                   | 01 thru 06               | 2 | 02 thru 04              | N or S |
| 60°    | 01 thru 04   | 3  |                |                 |                | 02                                | N                        |   |                         |        |
|        | 01 thru 03   | 4  |                |                 |                | 02                                | N                        |   |                         |        |
| 44     |  |  | 90°            | 01 thru 12      | 1              | 02 thru 04 <sup>3</sup>           | N                        |   |                         |        |
|        |  |  |                | 01 thru 06      | 2              | 02                                | N                        |   |                         |        |
| 44     | D<br>UD  | —<br>—   | 30°            | 01 thru 12      | 1              | AJ (2 thru 12) <sup>1</sup>       | N or S                   |   |                         |        |
|        |  |  |                | 01 thru 12      | 2              | AJ (2 thru 6) <sup>1</sup>        | N or S                   |   |                         |        |
| 42     |  |  | 36°            | 01 thru 08      | 3              | AJ (2 thru 4) <sup>1</sup>        | N or S                   |   |                         |        |
|        |  |  |                | 01 thru 06      | 4              | AJ (2 or 3) <sup>1</sup>          | N or S                   |   |                         |        |
| 42     | P<br>UP  | SP<br>USP  | 36°            | 01 thru 12      | 1              | AJ (2 thru 10) <sup>1</sup>       | N or S                   |   |                         |        |
|        |  |  |                | 01 thru 12      | 2              | AJ (2 thru 5) <sup>1</sup>        | N or S                   |   |                         |        |

**Concentric Shaft Switches**

| Series                              | Style Choices                                       | Angle of Throw | Section A (Front)        |        |   |                          | Section B (Rear)   |                         |                                       |                          |            |                                       |                  |
|-------------------------------------|---|----------------|--------------------------|--------|---|--------------------------|--|-------------------------|---------------------------------------|--------------------------|------------|---------------------------------------|------------------|
|                                     |   |                | Decks                    | Poles  | Position  | N or S                   | Decks  | Poles                   | Position                              | N or S                   |            |                                       |                  |
| <b>CONCENTRIC SHAFT, 2 SWITCHES</b> |   |                |                          |        |   |                          |  |                         |                                       |                          |            |                                       |                  |
| 54                                  | A <sup>2</sup><br>UA <sup>2</sup><br>M <sup>2</sup> | 30°            | 01 thru 03<br>01 thru 03 | 1      | 02 thru 12 <sup>3</sup><br>02 thru 06           | N or S<br>N or S         | 01 thru 03   | 1                       | 02 thru 12 <sup>3</sup><br>02 thru 06 | N or S<br>N or S         |            |                                       |                  |
|                                     |   |                |                          | 2      |   |                          | 01 or 02   | 3                       |                                       |                          | 02 thru 04 |                                       |                  |
|                                     |   |                | 43                       |        | 36°   | 01 thru 03<br>01 thru 03 | 1  | 02 thru 10 <sup>5</sup> | N or S                                | 01 thru 03<br>01 thru 03 | 1<br>2     | 02 thru 10 <sup>3</sup><br>02 thru 05 | N or S<br>N or S |
|                                     |   |                |                          |        |   |                          |  |                         |                                       |                          |            |                                       |                  |
|                                     |   |                |                          |        |   |                          |  |                         |                                       | 01                       | 5          | 02                                    | N or S           |
|                                     |   |                |                          |        |   |                          |  |                         |                                       | 01                       | 6          | 02                                    | N or S           |
| <b>ADD-A-POT SWITCHES</b>           |   |                |                          |        |   |                          |  |                         |                                       |                          |            |                                       |                  |
| 54                                  | D<br>UD   | 30°            | 01 thru 03<br>01 thru 03 | 1<br>2 | AJ (2-12) <sup>1</sup><br>AJ (2-6) <sup>1</sup> | N or S<br>N or S         | Second shaft operates a potentiometer supplied by the customer. Rear mounting plates are provided. |                         |                                       |                          |            |                                       |                  |
| 43                                  |   |                | 01 thru 03               | 1      | AJ (2-10) <sup>1</sup>                          | N or S                   |  |                         |                                       |                          |            |                                       |                  |
| 54                                  | M   | 30°            | 01 thru 03<br>01 thru 03 | 1<br>2 | 02 thru 12 <sup>5</sup><br>02 thru 06           | N or S<br>N or S         |  |                         |                                       |                          |            |                                       |                  |

<sup>1</sup>For Adjustable Stop (with the letter D), use AJ instead of number of positions when ordering.  
<sup>2</sup>For 45°, 60° or 90° throws in Series 54 switches of these styles, see Standard Options.  
<sup>3</sup>For single pole switches with the maximum positions per pole, continuous rotation is possible. Specify fixed stop or continuous rotation when ordering single shaft switches. Concentric shaft switches have continuous rotation.

<sup>4</sup>Styles which include both M and S are not qualified but are made of the same materials and construction as qualified types. For qualified switches with shaft and panel seal, use equivalent HS style.  
<sup>5</sup>UM switches are made of the same materials and construction as the M style switches. For military switch UM is not required; use M style.

**ACCESSORIES**

**Internal Tooth Lockwasher—Figure A**  
 For a 3/8" bushing. Approximately 0.500" (12,7) outside diameter, .022" (0,56) thickness. Material is cadmium-plated steel. Part No. 12Q1272-1

For a 1/4" bushing. Approximately 0.400" (10,16) outside diameter, .018" (0,46) thickness. Material is steel, tin/zinc plated.



bushing to the panel. The kit consists of four items: a grooved hex nut, a keyed washer, a keyed seal and a non-turn washer. Assembly is described on Page J-53. Dimensions of panel seal kit items are shown in Figure C. This kit seals the bushing to the panel; it does not seal the shaft to the bushing. Not usable with adjustable stop switches. Part No. 42-24

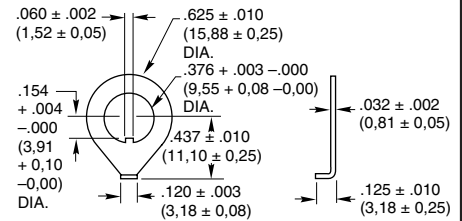

**Non-Turn Washer—Figure B**

Can be ordered as extra hardware for the Series 5000, 24, 42, 43, 44, 54, 71B, 53, 57 and 59 rotary switches. The internal key of the washer slides into the bushing keyway. The right angle tab locks into a predrilled hole on the back side of the mounting panel. Material is brass, tin/zinc plated. Part No. 12C1087-1

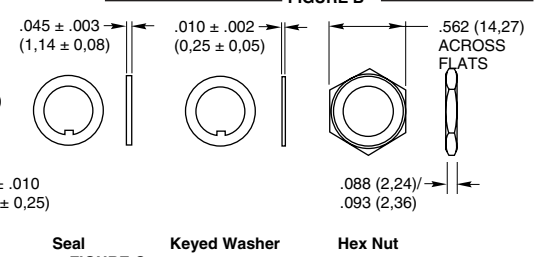
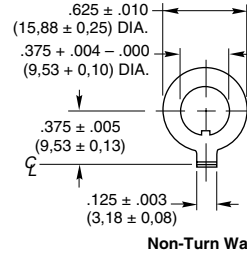

**Panel Seal Kit—Figure C**

Sold as a separate item to seal the switch

**ORDERING INFORMATION: Single Shaft Switches, Add-A-Pot Switches**

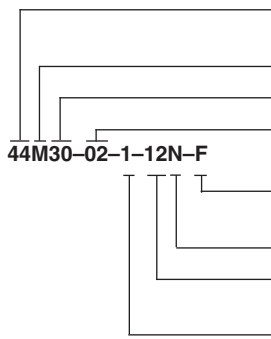

44M30-02-1-12N-F

- Series:** Determined by the type of switch and the angle of throw
- Style\*:** Letter(s) from the Choices and Limitations chart  
 Angle of Throw: Must agree with Series Number
- Number of Decks:** As limited by the angle of throw, the poles per deck, switch style and type of contacts
- Stop Arrangement:** Add letter F to a one pole per deck switch with the maximum number of positions for a stop between position 1 and the last position. Leave blank for continuous rotation
- Type of Contacts:** N = Non-shorting; S = Shorting
- Positions Per Pole:** Requires 02 positions as a minimum to maximum allowable dependent on the angle of throw and poles per deck. Use AJ for adjustable stops (Styles D and UD).
- Poles Per Deck:** As limited by angle of throw, switch series and style

\* All rotary switches that are required to have military designated markings and testing adhering to MIL-3786 are to be ordered by specifying the military part number identified on the appropriate slash sheet.

**ORDERING INFORMATION: Concentric Shaft Rotary Switches**

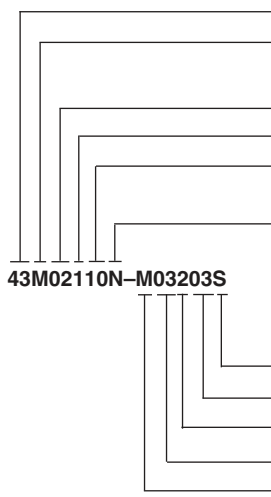

43M02110N-M03203S

- Series:** Determined by the angle of throw, applicable to both sections
- Style\*:** Letter(s) from the Choices and Limitations chart
- Section A (front)**
  - Number of Decks:** As limited by the number of poles per deck
  - Poles Per Deck:** As limited by the angle of throw
  - Positions Per Pole:** Requires 02 positions as a minimum to the maximum allowable dependent on the angle of throw and the poles per deck
  - Type of Contacts:** N=Non-shorting, S=Shorting. All one pole per deck switches with the maximum number of positions are continuous rotation
- Section B (rear)**  
 The limitations listed for Section A apply to Section B
  - Type of Contacts**
  - Positions Per Pole**
  - Poles Per Deck**
  - Number of Decks**
  - Style**

\* All rotary switches that are required to have military designated markings and testing adhering to MIL-3786 are to be ordered by specifying the military part number identified on the appropriate slash sheet.

Available from your local Grayhill Distributor

For prices and discounts, contact a local Sales Office, an authorized local Distributor or Grayhill.

## SERIES 44L High Current, 5 Amp

### LOCK FEATURES

- 8-Pin, Round Key Security
- Options for Flat Keys, Special Keying, and Key Removals

### SWITCH FEATURES

- High, 5 Amp Current Switching
- 45°, Up to 8 Poles Per Switch
- 25,000 Cycles of Operation
- RoHS Compliant



### DIMENSIONS in inches (and millimeters)

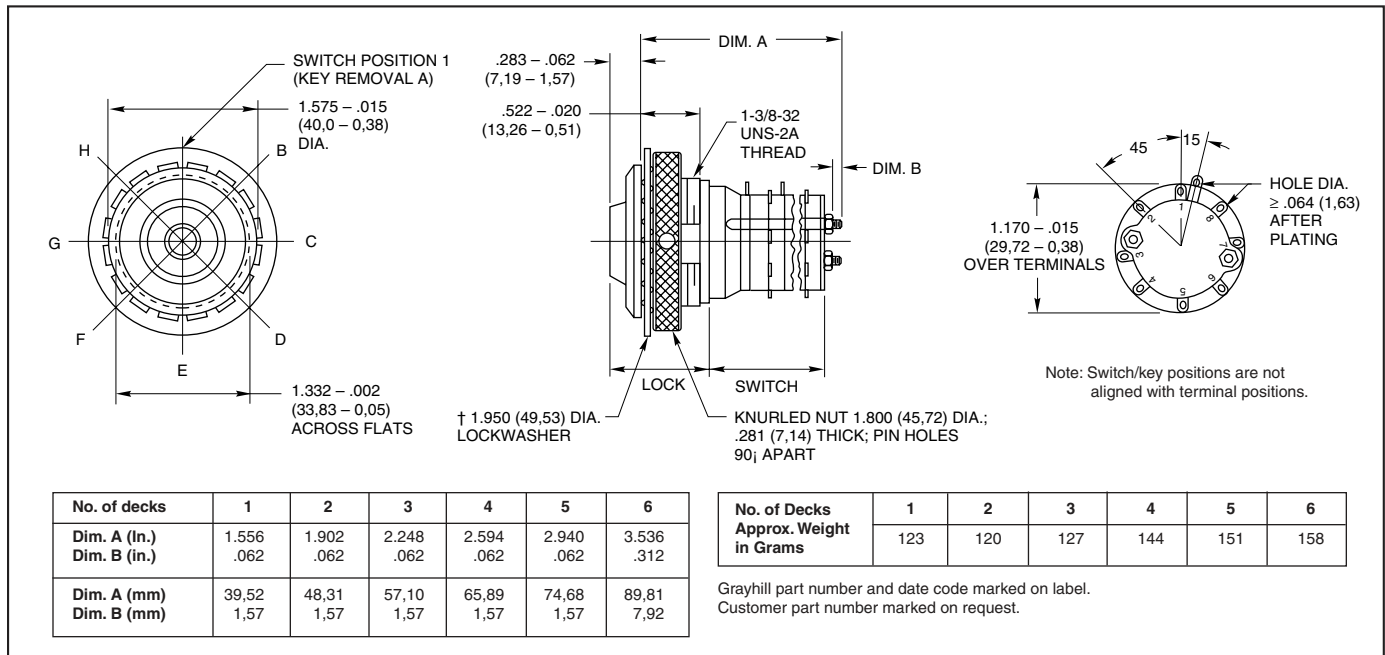

Rotary Switches

### RECOMMENDED PANEL CUT

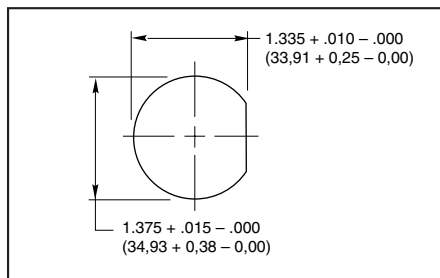

### LOCK SPECIFICATIONS

**Keying:** Each lock is keyed differently  
**Key Removal:** All positions (45°, etc)  
**Special Options:** Flat key with 90° or 180° increment key removals; 7 thru 12 decks

### LOCK MATERIALS AND FINISHES

**Bushing and Knurled Spanner Nut:** Aluminum, black anodized  
**Keying Washer, Cover Support Plate, Shaft Extension:** 302 Stainless steel  
**Internal and External Lockwashers:** Brass, tin/zinc-plated or stainless steel.  
**Keys, Cylindrical:** Stainless steel; 2 supplied

### CHOICES AND LIMITATIONS

| Style                     | Description           | Angle of Throw | No. Of Decks | Poles/Deck | Positions Per Pole | Shorting or Non-Shrtg. |
|---------------------------|-----------------------|----------------|--------------|------------|--------------------|------------------------|
| <b>Series 44 Switches</b> |                       |                |              |            |                    |                        |
| L                         | Standard, Solder Lugs | 45°            | 01 to 06     | 1          | 02 to 08           | N or S                 |
|                           |                       |                | 01 to 03     | 2          | 02 to 04           | N or S                 |
|                           |                       |                | 01 or 02     | 3          | 01 or 02           | N                      |
|                           |                       |                | 01 or 02     | 4          | 01 or 02           | N                      |

## SWITCH SPECIFICATIONS

### Electrical Characteristics Industrial Grade Switch

#### Switching Current and Life

The load-life values indicate the number of cycles of operation expected for the voltage, current and type of load. End of life is defined using the resistance and breakdown failure criteria listed below.

|       |                        |
|-------|------------------------|
| 5A at | 115 Vac, resistive     |
| 1A at | 6 to 28 Vdc, resistive |
| 2A at | 115 Vac, inductive     |

**Cycle of Operation:** 360° rotation plus a 360° return

**Test Conditions:** 25°C, 68% relative humidity, atmospheric pressure

#### Life Expectancy:

|                   |                |
|-------------------|----------------|
| With loads above: | 25,000 cycles  |
| Without load:     | 100,000 cycles |

#### Contact Resistance:

|              |                 |
|--------------|-----------------|
| End of life: | less than 20 mΩ |
|--------------|-----------------|

#### Insulation Resistance:

(Between mutually insulated parts)

|            |           |
|------------|-----------|
| Initially: | 50,000 MΩ |
|------------|-----------|

#### Breakdown Voltage:

(Between mutually insulated parts)

|              |           |
|--------------|-----------|
| Initially:   | 1,000 Vac |
| End of life: | 500 Vac   |

**Carry Current:** 10A; maximum temperature rise 20°C

### Mechanical Characteristics

#### Switching Mode:

45°, 1 or 2 poles: Shorting or non-shorting 45°,  
3 or 4 poles: Non-shorting

**Type of Contact:** Wiping contacts

**Contact Force:** greater than 150g

**Number of Terminals:** Switches are provided with only the number of terminals needed

**Stop Strength:** greater than 15 in-lbs (1.70 Nm)

**Switching Torque:** 8-115 in-ozs (28 to 230 mNm), depending on the number of poles, number of decks, and angle of throw

#### Additional Characteristics

Switches of 6 or more decks have longer studs with extra mounting nuts for recommended double end mount

Operating Temperature Range: -40 °C to +85 °C

### Materials and Finishes: Switch

**Switch Bases:** Melamine per MIL-M-14, 4

#### Switch Bases:

Industrial Grade: Melamine per MIL-M-14

Military: Diallyl per MIL-M-14

**Cover, Deck Separators, End Plate, and Rotor Mounting Plate:** Phenolic per MIL-M-14

**Shaft, Shaft Extension, Stop Arm, Stop Washers, Rear Support Plate, Cover Plate, Retaining Ring, Studs, Nuts:** Stainless steel

**Detent Balls:** Steel, nickel-plated

**Detent Springs:** Tinned music wire

**Rotor Contact, and Stator (Base) Con-**

**tacts:** Silver alloy

**Common Plate, and Common Terminal:**

Brass, 300μ inch, (7.6 μm) silver plate

**Base Terminals:** Brass, tin plated

## ORDERING INFORMATION

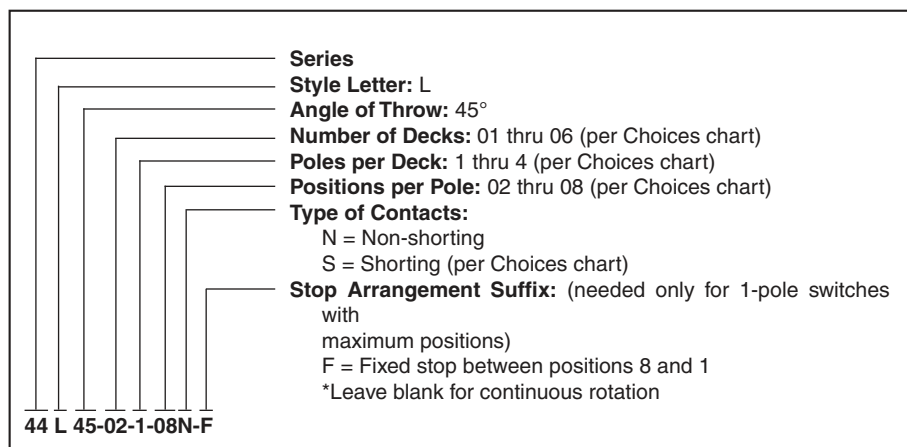

### Available from your local Grayhill Distributor.

For prices and discounts, contact a local Sales Office, an authorized local Distributor or Grayhill.



## Adjustable Stop Rotary Switches

### Features

- Quick Route to Rotary Switches
- For Prototypes and Small Production Runs

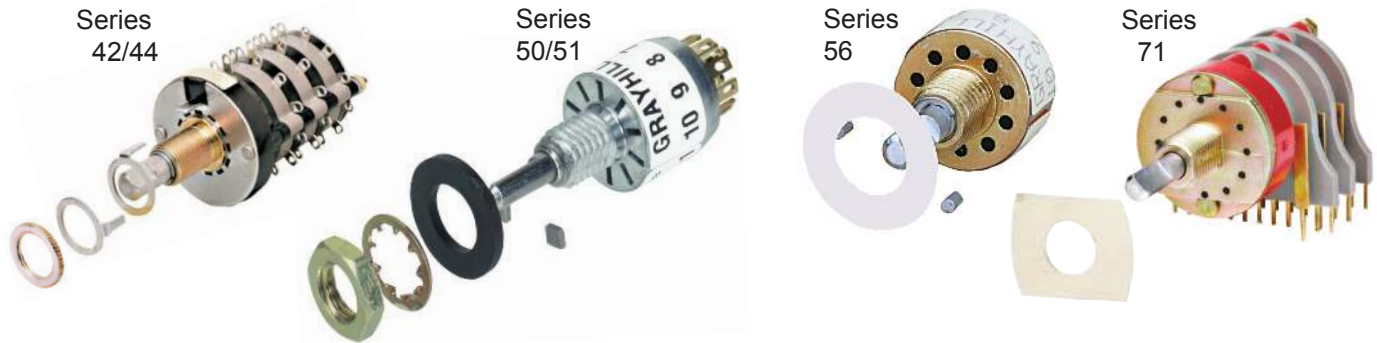

### BEST AVAILABILITY

#### The Problem

Procurement lead time on rotary switches for prototypes and small production runs can be long. This is often a source of headache for design engineers and production control managers.

Grayhill makes more than 300,000 combinations of rotary switch styles; number of decks, poles per deck, positions per pole, military qualified or commercial grade, etc. This wide variety makes it impractical for either distributors or manufacturers to stock completed switches. Consequently, even small quantities must be built to order.

#### The Solution

Grayhill Electronic Distributors can supply a wide variety of rotary switches with Adjustable Stops. This feature gives you a switch immediately with exactly the electrical properties you need. These Adjustable Stop switches have the basic mechanical characteristics of their fixed stop counterparts. To get the right number of positions per pole for your application, simply adjust the

stop washers or stop pins.

By stocking a few switches, the Distributor provides over 100,000 possible combinations of switches. This includes the popular styles, sizes, angles of throw, number of decks, poles per deck, positions per pole, and types of contacts. Availability of these switches through Distributors speeds prototype development time. There is no time lag in waiting for factory made samples.

#### The Substitution

Writing an equivalent part number is easy. To obtain an adjustable-stop equivalent to a fixed-stop rotary switch you must substitute style letters and possibly series number. Then replace the positions-per-pole number in the fixed-stop number with the letters AJ. See the examples for the scheme.

When adjustable equivalents apply, the rotary switch pages will indicate the substitutions. A chart will show the fixed stop rotary switch

series, style and angle of throw as well as the adjustable stop rotary switch series, style and angle of throw. Then the letters AJ in the positions-per-pole location, gives you the part number of the equivalent.

#### Suppliers

Distributors can supply 1 and 2-deck adjustable-stop switches from stock (one or two poles per deck). They can also quickly secure other variations from factory stock. Reduce prototype development time. Use Grayhill Adjustable Stop Rotary Switches for all of your prototype requirements.

These electronic distributors also maintain a representative stock of Grayhill products. Local availability can often "save the day", and simplify your paperwork.

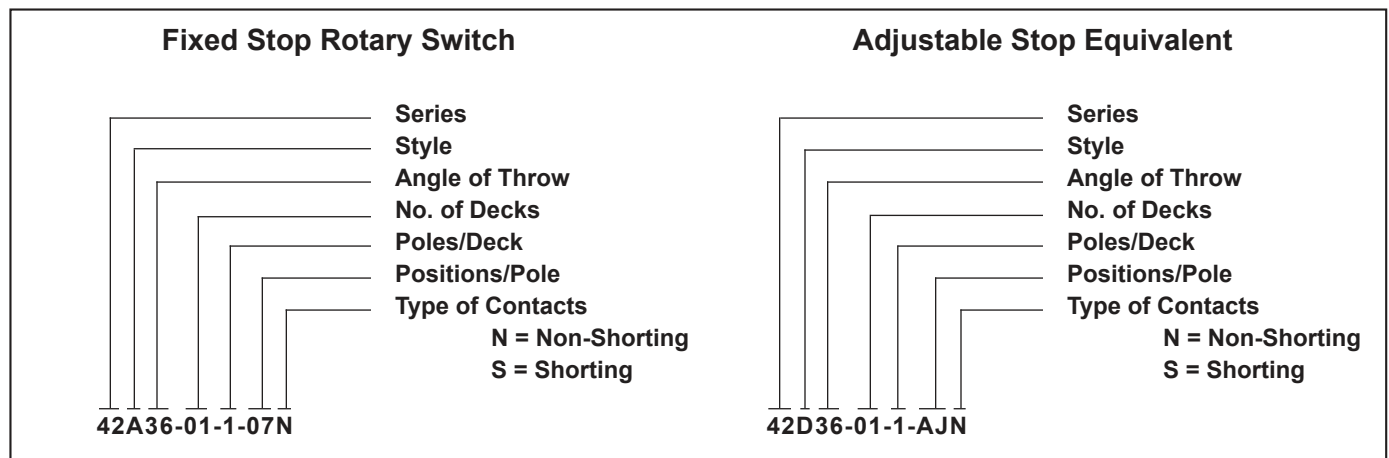

## SERIES 09, 42, 44, 50, 51 Isolated Position

### FEATURES

- Protected Switch Positions For Safety, Calibration, or Stand-by
- Choice of Push- or Pull-To-Turn
- 1/2" Diameter, 200 mA and 1" Diameter, 1 Amp Switch
- 10,000 Cycles of Operation

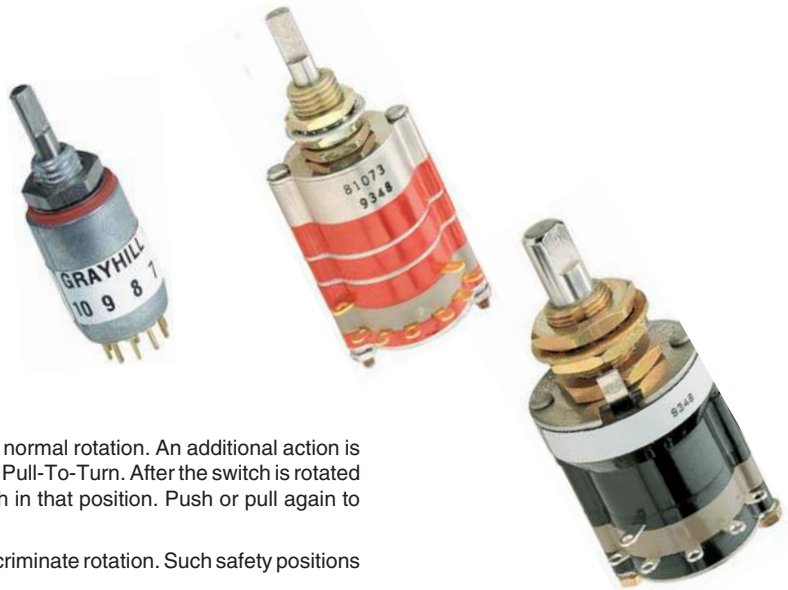

### DESCRIPTION

An isolated position is one which cannot be reached by the normal rotation. An additional action is required by the operator. It could be either Push-To-Turn, or Pull-To-Turn. After the switch is rotated to the isolated position, releasing the shaft locks the switch in that position. Push or pull again to rotate the switch again.

Use isolated positions to protect a switch position from indiscriminate rotation. Such safety positions might include "calibrate", "off" and/or "stand-by".

### DIMENSIONS

| Series 09   |   | Series 50 & 51 |             | Series 42 & 44 |               |         |              |         |               |         |               |  |   |  |             |            |                            |          |                            |  |  |  |             |        |               |         |               |         |               |         |               |
|---|---|----------------|-------------|----------------|---------------|---------|--------------|---------|---------------|---------|---------------|--|---|--|-------------|------------|----------------------------|----------|----------------------------|--|--|--|-------------|--------|---------------|---------|---------------|---------|---------------|---------|---------------|
|   |   |                |             |                |               |         |              |         |               |         |               |  |   |  |             |            |                            |          |                            |  |  |  |             |        |               |         |               |         |               |         |               |
|   | <table border="1"> <thead> <tr> <th></th> <th>Dimension A</th> </tr> </thead> <tbody> <tr> <td>1 Deck</td> <td>1.228 (31,19)</td> </tr> <tr> <td>2 Decks</td> <td>1.496 (38,0)</td> </tr> <tr> <td>3 Decks</td> <td>1.764 (44,81)</td> </tr> <tr> <td>4 Decks</td> <td>2.032 (51,61)</td> </tr> </tbody> </table> |                | Dimension A | 1 Deck         | 1.228 (31,19) | 2 Decks | 1.496 (38,0) | 3 Decks | 1.764 (44,81) | 4 Decks | 2.032 (51,61) |  | <table border="1"> <thead> <tr> <th></th> <th>Dimension A</th> </tr> </thead> <tbody> <tr> <td>Solder Lug</td> <td>.893 ± .025 (22,68 ± 0,64)</td> </tr> <tr> <td>PC Style</td> <td>.897 ± .025 (22,78 ± 0,64)</td> </tr> </tbody> </table> |  | Dimension A | Solder Lug | .893 ± .025 (22,68 ± 0,64) | PC Style | .897 ± .025 (22,78 ± 0,64) |  | <table border="1"> <thead> <tr> <th></th> <th>Dimension A</th> </tr> </thead> <tbody> <tr> <td>1 Deck</td> <td>1.371 (34,82)</td> </tr> <tr> <td>2 Decks</td> <td>1.717 (43,61)</td> </tr> <tr> <td>3 Decks</td> <td>2.063 (52,40)</td> </tr> <tr> <td>4 Decks</td> <td>2.409 (61,19)</td> </tr> </tbody> </table> |  | Dimension A | 1 Deck | 1.371 (34,82) | 2 Decks | 1.717 (43,61) | 3 Decks | 2.063 (52,40) | 4 Decks | 2.409 (61,19) |
|   | Dimension A   |                |             |                |               |         |              |         |               |         |               |  |   |  |             |            |                            |          |                            |  |  |  |             |        |               |         |               |         |               |         |               |
| 1 Deck  | 1.228 (31,19)   |                |             |                |               |         |              |         |               |         |               |  |   |  |             |            |                            |          |                            |  |  |  |             |        |               |         |               |         |               |         |               |
| 2 Decks   | 1.496 (38,0)  |                |             |                |               |         |              |         |               |         |               |  |   |  |             |            |                            |          |                            |  |  |  |             |        |               |         |               |         |               |         |               |
| 3 Decks   | 1.764 (44,81)   |                |             |                |               |         |              |         |               |         |               |  |   |  |             |            |                            |          |                            |  |  |  |             |        |               |         |               |         |               |         |               |
| 4 Decks   | 2.032 (51,61)   |                |             |                |               |         |              |         |               |         |               |  |   |  |             |            |                            |          |                            |  |  |  |             |        |               |         |               |         |               |         |               |
|   | Dimension A   |                |             |                |               |         |              |         |               |         |               |  |   |  |             |            |                            |          |                            |  |  |  |             |        |               |         |               |         |               |         |               |
| Solder Lug  | .893 ± .025 (22,68 ± 0,64)  |                |             |                |               |         |              |         |               |         |               |  |   |  |             |            |                            |          |                            |  |  |  |             |        |               |         |               |         |               |         |               |
| PC Style  | .897 ± .025 (22,78 ± 0,64)  |                |             |                |               |         |              |         |               |         |               |  |   |  |             |            |                            |          |                            |  |  |  |             |        |               |         |               |         |               |         |               |
|   | Dimension A   |                |             |                |               |         |              |         |               |         |               |  |   |  |             |            |                            |          |                            |  |  |  |             |        |               |         |               |         |               |         |               |
| 1 Deck  | 1.371 (34,82)   |                |             |                |               |         |              |         |               |         |               |  |   |  |             |            |                            |          |                            |  |  |  |             |        |               |         |               |         |               |         |               |
| 2 Decks   | 1.717 (43,61)   |                |             |                |               |         |              |         |               |         |               |  |   |  |             |            |                            |          |                            |  |  |  |             |        |               |         |               |         |               |         |               |
| 3 Decks   | 2.063 (52,40)   |                |             |                |               |         |              |         |               |         |               |  |   |  |             |            |                            |          |                            |  |  |  |             |        |               |         |               |         |               |         |               |
| 4 Decks   | 2.409 (61,19)   |                |             |                |               |         |              |         |               |         |               |  |   |  |             |            |                            |          |                            |  |  |  |             |        |               |         |               |         |               |         |               |
| <p>Grayhill part number and date code marked on label. Customer number marked on request.</p> |   |                |             |                |               |         |              |         |               |         |               |  |   |  |             |            |                            |          |                            |  |  |  |             |        |               |         |               |         |               |         |               |

### EXTERNAL DIFFERENCES

The isolated position mechanism increases the depth of the Series 50 and 51 by 0.217" (5,51 mm). All other dimensions remain unchanged. In Series 9, 42 and 44, it has the appearance of an additional deck section without terminals, located directly behind the detent system.

### SPECIFICATIONS

#### Electrical Ratings

The switching elements, and therefore ratings, are the same in an isolated position switch as in a conventional rotary switch. Mechanical life is also the same.

#### Additional Characteristics

##### Shaft Movement or Vertical Travel:

|                |                           |
|----------------|---------------------------|
| Series 09      | .062 ± .020 (1,57 ± 0,51) |
| Series 42 & 44 | .070 ± .020 (1,78 ± 0,51) |
| Series 50 & 51 | .080 ± .020 (2,03 ± 0,51) |

##### Push or Pull Force Required:

|                |               |
|----------------|---------------|
| Series 09      | 1.75 ± .5 lbs |
| Series 42 & 44 | 2 ± .5 lbs    |
| Series 50 & 51 | 2 ± .5 lbs    |

**Stops:** Single pole per deck switches with the maximum number of positions are supplied with stops only on request: 12 positions in 30° throw, 10 in 36°, and 8 in 45°.

**Stop Strength:** Approximately 7.5 pound-inches for the isolated position stop.

#### Materials and Finishes

Materials and finishes for the isolation mechanism are listed here.

##### Series 50 and 51

**Housing:** Zinc casting, tin/zinc-plated

**Shaft:** 303 stainless steel

**Stop Pin and Stop Post:** 303 stainless steel

**Spring:** Tinned music wire

##### Series 09

**Housing:** Phenolic for style A; Diallyl, for M

**Shaft:** 303 stainless steel, electro-polished

**Stop Pin and Stop Post:** 303 stainless steel

**Spring:** Tinned music wire

##### Series 42 and 44

**Housing:** Diallyl per MIL-M-14

**Shaft:** 303 stainless steel

**Lock Plate:** 302 stainless steel

**Lock Arm:** 316 stainless steel

**Lock Post:** Brass, tin/zinc-plated

**Compression Spring:** Tinned music wire

**CHOICES AND LIMITATIONS**

| Standard Style       | Military Style**             | Style Description   | Angle Of Throw | No. Of Decks   | Poles Per Deck             | Positions Per Pole                                       | Shorting Or Non-Shorting                                 |
|----------------------|------------------------------|---|----------------|--|----------------------------|--|--|
| 09A                  | 09M                          | Solder Lug  | 30°            | 01 to 04<br>01 to 04<br>01 to 04<br>01 to 04<br>01 to 04<br>01 to 03 | 1<br>2<br>3<br>4<br>5<br>6 | 02 to 12<br>02 to 06<br>02 to 04<br>02 or 03<br>02<br>02 | N or S<br>N or S<br>N or S<br>N or S<br>N or S<br>N or S |
| 42A<br>42S<br>—<br>— | 42M<br>—<br>42H<br>42HS      | Solder Lug<br>Sealed<br>125° Temperature Rating<br>125° Temp Rating, Sealed | 36°            | 01 to 04<br>01 to 04   | 1<br>2                     | 02 to 10<br>02 to 05                                     | N or S<br>N or S   |
| 44A<br>44S<br>—<br>— | 44M<br>—<br>44H<br>44HS      | Solder Lug<br>Sealed<br>125° Temperature Rating<br>125° Temp Rating, Sealed | 30°            | 01 to 04<br>01 to 04<br>01 to 04<br>01 to 04<br>01 to 04<br>01 to 04 | 1<br>2<br>3<br>4<br>5<br>6 | 02 to 12<br>02 to 06<br>02 to 04<br>02 or 03<br>02<br>02 | N or S<br>N or S<br>N or S<br>N or S<br>N or S<br>N or S |
|                      |                              |   | 45°            | 01 to 04<br>01 to 03<br>01 or 02<br>01 or 02                         | 1<br>2<br>3<br>4           | 02 to 08<br>02 to 04<br>02<br>02                         | N or S<br>N or S<br>N or S<br>N                          |
| --<br>--<br>--<br>-- | 50C<br>50CP<br>50M*<br>50MP* | Solder Lug<br>PC Mount<br>Solder Lug, Sealed<br>Sealed, PC                  | 36°            | 01   | 1<br>2                     | 02 to 10<br>02 to 05                                     | N or S<br>N or S   |
| --<br>--<br>--<br>-- | 51C<br>51CP<br>51M*<br>51MP* | Solder Lug<br>PC Mount<br>Solder Lug, Sealed<br>PC Mount, Sealed            | 30°            | 01   | 1<br>2<br>3<br>4           | 02 to 12<br>02 to 06<br>02 or 03<br>02 or 03             | N or S<br>N or S<br>N or S<br>N or S                     |

\*(Pull-to-Turn only) \*\*For specifics on military qualified products, see Standard Switch Pages.

**CONVENTIONAL NUMBERS**

Start by creating a conventional switch number in the manner which follows:

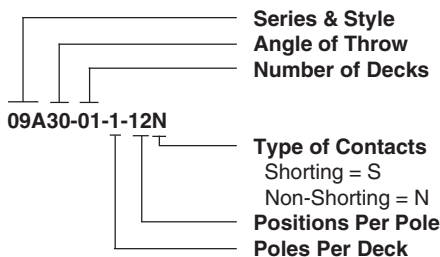

Note: No stop arrangement suffix is needed. See Describing Stops.

**DESCRIBING POSITIONS**

The Grayhill system for isolating positions lets you choose the positions to be isolated. Grayhill inserts isolation posts next to the positions to be isolated. Consider a continuous rotation switch of the Series 09A with a 30° angle of throw. The terminals are listed here from 1 through 12 with a space between each to indicate where isolation posts might be inserted.

12 1 2 3 4 5 6 7 8 9 10 11 12

Let's isolate position 1 and position 2 from all other positions and from each other. We indicate isolation posts as shown here:

12P1P2P3 4 5 6 7 8 9 10 11 12

To isolate just position 1, describe like this:

12P1P2 3 4 5 6 7 8 9 10 11 12

To isolate positions 1 and 2 from all other positions, but not from each other, do this:

12P1 2P3 4 5 6 7 8 9 10 11 12

**DESCRIBING STOPS**

When a 1-pole switch has less than the maximum number of positions, consider also the stop system. Following is the arrangement for a 6 position switch with the position 1 isolated.

STOP 1P2 3 4 5 6 STOP

The word "STOP" indicates the conventional switch stops, which limit rotation to positions 1 through 6. To isolate position 1 we insert only one isolation post—between terminals 1 and 2. The stop system already prevents rotation beyond terminal 1.

In multi-pole switches, the stop system and isolation system described for the first pole, automatically affects the other poles. In the example above, isolating position #1 on the first pole isolates the first position (terminal #7) of the second pole. See Standard Switch Pages for a 2 pole circuit diagram for a 30° throw switch.

**ORDERING INFORMATION**

Indicate this as a SPECIAL switch to ensure that no error is made when the order is entered. Sample part number:

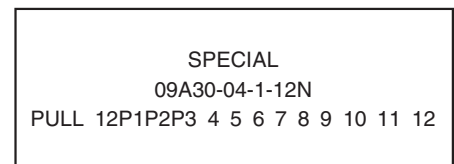

This sample part number orders a Series 9 standard style, four deck, one pole per deck, twelve positions per pole rotary switch with non-shorting contacts and isolation posts between positions 12 and 1, between 1 and 2, and between 2 and 3.

This lengthy order number is required to prevent any possible confusion in ordering the switch. When we receive your order, we will assign a special "short form" part number to facilitate future identification of this special switch. This number is sequentially assigned as the need arises, and is non-descriptive. A typical "short form" special part number might be 09YY12345. Contact Grayhill for price.

**Not available through Distributors.**

Rotary Switches

## SERIES 08,09,42,44,50 Spring Return

### FEATURES

- Hold-To-Test, Hold-To-Calibrate, And Other Momentary Applications
- Choice of Configurations, Ratings, Styles and Circuitry
- 10,000 Cycles of Operation

### DESCRIPTION

A spring return rotary switch has 1 or more momentary positions. Maintaining contact at momentary positions requires rotational force. Releasing the force allows the mechanism to return the contact to a normal, or detent, position.

### DIMENSIONS

#### Series 08 & 09

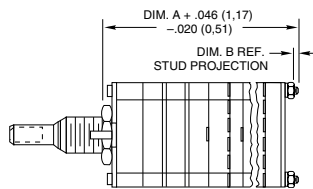

| No. of Decks | Dim A         | Dim B       |
|--------------|---------------|-------------|
| 1            | .960 (24,38)  | .062 (1,57) |
| 2            | 1.228 (31,19) | .062 (1,57) |
| 3            | 1.496 (38,0)  | .062 (1,57) |
| 4            | 1.764 (44,81) | .062 (1,57) |
| 5            | 2.032 (51,61) | .062 (1,57) |
| 6            | 2.550 (64,77) | .312 (7,92) |

For all other dimensions and specifications, see Standard Switch pages.

#### Series 50

Equivalent to Series 50 Standard Switches

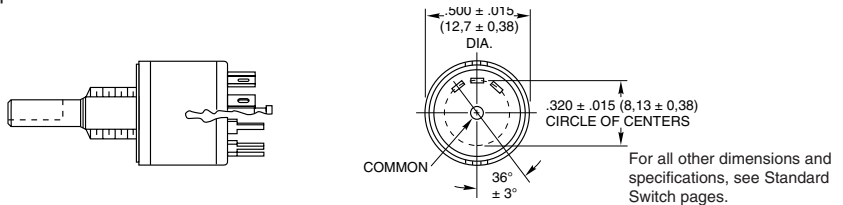

For all other dimensions and specifications, see Standard Switch pages.

#### Series 42 & 44

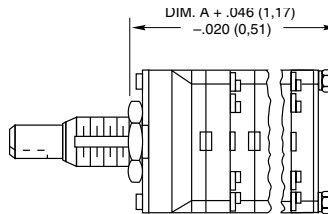

| No. of Decks | Dim. A        |
|--------------|---------------|
| 1            | 1.025 (26,04) |
| 2            | 1.371 (34,82) |
| 3            | 1.717 (43,61) |

For all other dimensions and specifications, see Standard Switch pages.

### CONFIGURATIONS

This configuration indicates a counterclockwise force is required to hold the switch at position #1. "M" indicates a momentary position counterclockwise of "D" and "D", detented ones.

| Positions | 1 | 2 | 3 |
|-----------|---|---|---|
|           | M | D | D |

Releasing this force breaks contact with position #1 and returns the switch to #2. Normal rotary switch detent action occurs when the switch is rotated between position #2 and #3.

All of the configurations (except *MDM*) list a basic 2 position arrangement which is shown in italics. Example: *MDDDDD* or *DDDDDM*. Several positions can be added during the switch construction at the factory; but, any configuration must always contain the 2 basic positions.

### SELECTING A SWITCH

**1. Select a Configuration:** The total number of positions always includes the 2 basic positions. A (4) position switch of *DDDDM* configuration would have 3 detent positions counterclockwise of the momentary position.

**2. Select Series, Angle of Throw, and Style:** See the Choices Chart. The basic switch description, series, and throw are as follows:  
 1/2", 1/4 Amp, multi-deck 08 = 36° 09 = 30°  
 1", 1 Amp, multi-deck 42 = 36° 44 = 30°  
 1/2", 200 mA, single deck 50 = 36°

Electrical ratings are the same as those of the conventional switches with the exception of life. Life is limited to 10,000 cycles of operation (25,000 cycles for Series 50) due to the spring arrangement. Dimensions are the same as for conventional types except for the shaft flat orientation of the 3, 4, 5, and 6 pole, Series 09 and 44 in the *DDDDDM* configuration (see chart).

**3. Select Poles & Positions Per Pole:** If you do not find the poles and positions per pole you need in one series, try another or contact the factory. If the behind panel length is a problem, select a multi-pole type instead of a single deck.

### OPTIONS

Watertight panel seal; Multi-pole switches that exceed the limits noted in the Selector Chart; Series 50 *MD* or *DM* configurations in Military styles; Series 08, 09, & 44 in *MMMDMM*, and in *MMDDMM*, and in *MMMMMD*.

**Not available through Distributors**

### ORDERING INFORMATION

Create the part number using this example.

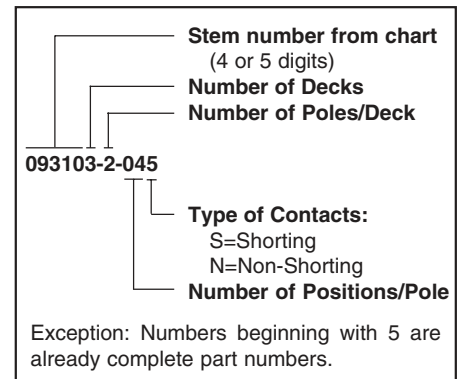

**CHOICES AND LIMITATIONS**

| Con-figuration | Conven-tional Switch | Description Of Style | Spring Return Stem Number (See Ordering Info.) | No. Of Decks                         | Poles Per Deck             | Positions Per Pole & Contact Type   | Location Of Unique Position, Detent or Momentary                      | Term. Opp. Flat**     |
|----------------|----------------------|----------------------|--|--------------------------------------|----------------------------|---|---|-----------------------|
| DDDDDM         | 08A36                | Standard             | 08317  | 1 to 6<br>1 to 3                     | 1<br>2                     | 02 to 05 (N or S)<br>02 to 05 (N or S)  | M 5<br>M 5, 10  | 5<br>5                |
|                | 09A30                | Standard             | 09310  | 1 to 6<br>1 to 3<br>1 or 2<br>1<br>1 | 1<br>2<br>3<br>4<br>5 or 6 | 02 to 06 (N or S)<br>02 to 06 (N or S)<br>02 to 04 (N or S)<br>02 or 03 (N or S)<br>02 (N or S) | M 6<br>M 6, 12<br>M 4, 8, 12<br>M 3, 6, 9, 12<br>M 2, 4, 6, 8, 10, 12 | 6<br>6<br>4<br>3<br>2 |
|                | 42A36                | Standard             | 42349  | 1 to 3<br>1                          | 1<br>2                     | 02 to 05 (N or S)<br>02 to 05 (N or S)  | M 5<br>M 5, 10  | 5<br>5                |
|                | 42M36                | Military             | 42352  | 1 to 3<br>1                          | 1<br>2                     | 02 to 05 (N or S)<br>02 to 05 (N or S)  | M 5<br>M 5, 10  | 5<br>5                |
|                | 44A30                | Standard             | 44346  | 1 to 3<br>1                          | 1<br>2                     | 02 to 06 (N or S)<br>02 to 06 (N or S)  | M 6<br>M 6, 12  | 6<br>6                |
|                | 44M30                | Military             | 44350  | 1 to 3<br>1                          | 1<br>2                     | 02 to 06 (N or S)<br>02 to 06 (N or S)  | M 6<br>M 6, 12  | 6<br>6                |
| MDDDDD         | 08A36                | Standard             | 08319  | 1 to 6<br>1 to 3                     | 1<br>2                     | 02 to 05 (N or S)<br>02 to 05 (N or S)  | M 1<br>M 1, 6   | 1<br>1                |
|                | 09A30                | Standard             | 09312  | 1 to 6<br>1 to 3<br>1 or 2<br>1<br>1 | 1<br>2<br>3<br>4<br>5 or 6 | 02 to 06 (N or S)<br>02 to 06 (N or S)<br>02 to 04 (N or S)<br>02 or 03 (N or S)<br>02 (N or S) | M 1<br>M 1, 7<br>M 1, 5, 9<br>M 1, 4, 7, 10<br>M 1, 3, 5, 7, 9, 11    | 1<br>1<br>1<br>1<br>1 |
|                | 09M30                | Military             | 09356  | 1 to 3<br>1<br>1                     | 1<br>2<br>3                | 02 to 06 (N or S)<br>02 to 06 (N or S)<br>02 to 04 (N or S)                                     | M 1<br>M 1, 7<br>M 1, 5, 9  | 1<br>1<br>1           |
|                | 42A36                | Standard             | 42350  | 1 to 3<br>1                          | 1<br>2                     | 02 to 05 (N or S)<br>02 to 05 (N or S)  | M 1<br>M 1, 6   | 1<br>1                |
|                | 42M36                | Military             | 42353  | 1 to 3<br>1                          | 1<br>2                     | 02 to 05 (N or S)<br>02 to 05 (N or S)  | M 1<br>M 1, 6   | 1<br>1                |
|                | 44A30                | Standard             | 44312  | 1 to 3<br>1                          | 1<br>2                     | 02 to 06 (N or S)<br>02 to 06 (N or S)  | M 1<br>M 1, 7   | 1<br>1                |
|                | 44M30                | Military             | 44351  | 1 to 3<br>1                          | 1<br>2                     | 02 to 06 (N or S)<br>02 to 06 (N or S)  | M 1<br>M 1, 7   | 1<br>1                |
| MDM            | 50A36                | Std., Solder Lug     | 503265-1-03N*                                  | 1                                    | 1                          | 03N   | D 2   | 2                     |
|                | 50P36                | Std., PC Mount       | 503267-1-03N*                                  | 1                                    | 1                          | 03N   | D 2   | 2                     |
|                | 8A36                 | Standard             | 08316  | 1 to 6<br>1 to 3                     | 1<br>2                     | 03 (N or S)<br>03 (N or S)  | D 2<br>D 2, 7   | 2<br>2                |
|                | 9A30                 | Standard             | 09311  | 1 to 6<br>1 to 3<br>1 or 2<br>1      | 1<br>2<br>3<br>4           | 03 (N or S)<br>03 (N or S)<br>03 (N or S)<br>03 (N or S)  | D 2<br>D 2, 8<br>D 2, 6, 10<br>D 2, 5, 8, 11                          | 2<br>2<br>2<br>2      |
|                | 42A36                | Standard             | 42348  | 1 to 3<br>1                          | 1<br>2                     | 03 (N or S)<br>03 (N or S)  | D 2<br>D 2, 7   | 2<br>2                |
|                | 42M36                | Military             | 42351  | 1 to 3<br>1                          | 1<br>2                     | 03 (N or S)<br>03 (N or S)  | D 2<br>D 2, 7   | 2<br>2                |
|                | 44A30                | Standard             | 44345  | 1 to 3<br>1                          | 1<br>2                     | 03 (N or S)<br>03 (N or S)  | D 2<br>D 2, 8   | 2<br>2                |
|                | 44M30                | Military             | 44349  | 1 to 3<br>1                          | 1<br>2                     | 03 (N or S)<br>03 (N or S)  | D 2<br>D 2, 8   | 2<br>2                |

\*This is a complete (not stem) part number.  
 \*\*Terminal opposite shaft flat when switch is in its unique (detent or momentary) position.

Available from your local Grayhill Distributor

For prices and discounts, contact a local Sales Office, an authorized local Distributor, or Grayhill.



## Rotary Switch Engineering Information

### Catalog Ratings

Are catalog ratings misleading? In most cases, yes. Load and life ratings shown in most catalogs are usually invalid for most applications. This results from the complex interplay of such factors as environment, duty cycle, life limiting or failure criteria, actual load, etc. Circuit designers should be aware of these factors, and the effect they have on the useful life of the switch in their applications.

The problem of switch rating arises from the wide variety of requirements placed on the switch. This includes various applications, and the sensitivity of the switch to a change in requirements. If we attempted to establish life ratings for all possible applications, we would have an almost infinite variety of ratings.

To simplify the problem, switch manufacturers, switch users, and the military, have established certain references for ratings. These include loads, life requirements, environments, duty cycles, and failure criteria. These references are arbitrarily established. But, they allow you to compare different switch designs. They do not, however, match the actual requirements for most applications.

The curves shown here are an example of some of the life load curves. These curves are life load characteristics of the Grayhill 42M and 44M switches. Note that the curves consider only two voltage sources and two types of loads. These voltages and loads are, however, considered as standards for testing procedures by the industry.

Curve data is based on tests conducted at sea level, 25°C and 68% relative humidity. Cycle = 360° rotation and return. Cycling rate is 10 cycles per minute. Switch rating is for non-shorting contacts.

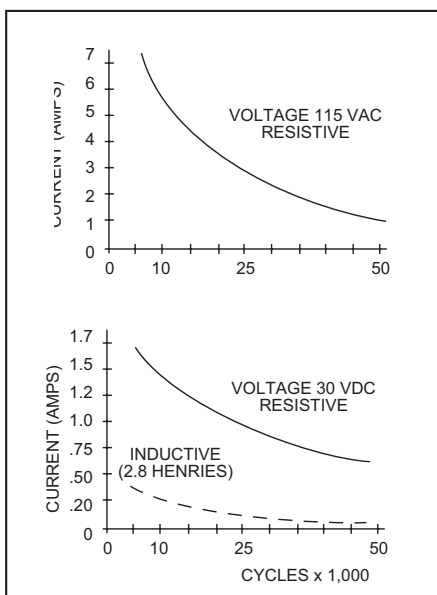

These curves allow you to predict the expected life of the switch once you know the voltage, current and type of load. Also note that each cycle is approximately a 360° rotation and a return. For a ten position switch this would be a rotation from position 1 to position 10 and back to 1. This cycle runs approximately ten times a minute. Thus testing causes more electrical and mechanical wear than what the switch incurs in actual use.

### Summary

The life and load ratings in this and other catalogs are probably not totally valid for your application. The bright side of the picture is that in most applications the switch will perform better than its ratings. This is because the standard industry test conditions are more stringent than those found in most applications.

This difference can be very dramatic. For example, Grayhill's 42A and 44A Series Rotary Switches, are rated at 1 ampere (115 Vac resistive). However, they will operate at 5 amperes in many applications. To see how some major factors influence switch performance, read on.

### USEFUL LIFE CRITERIA

The "useful" life of a switch in your application depends on what you demand of it. This includes parameters such as contact resistance, insulation resistance, torque, detent feel, dielectric strength, and many other factors. For example, a contact resistance of 50 milliohms may be totally unusable in certain applications such as a range switch in a micro-ohm meter. In other applications a contact resistance of 5 ohms may be perfectly satisfactory.

In establishing "useful" life for a switch in your application, you must first determine "failure criteria," or "end of life" parameters. At what level of contact resistance, dielectric strength, etc., is the switch no longer acceptable for your application?

Most switches are acceptable on all parameters when new. There is a gradual deterioration in performance with life. The rate of deterioration varies greatly with basic switch design. Often, circuit designers select a switch on the basis of its performance when new. This is a mistake. The performance of the switch after several years of equipment use is more significant. To estimate this, first determine the life limiting or failure criteria for your application. In most uses, important life-limiting (failure) criteria include the following parameters:

- Contact Resistance
- Insulation Resistance
- Dielectric Strength
- Actuating Force

### Contact Resistance

This is the resistance of a pair of closed contacts. This resistance effectively appears in series with the load. Typical values are in the range of a few milliohms for new switches. These values usually increase during life. The rate of increase is greatly affected by the voltage, current, power factor, frequency, and environment of the load being switched. Typical industry standard "end of life" criteria for this parameter are:

|               |                                    |
|---------------|------------------------------------|
| MIL-DTL-3786: | 20 milliohms<br>(Rotary Switches)  |
| MIL-S-6807:   | 20 milliohms<br>(Snap Pushbuttons) |
| MIL-S-8805:   | 40 milliohms<br>(Pushbuttons)      |
| MIL-S-83504:  | 100 milliohms<br>(DIP Switches)    |

Contact resistance can be measured by a number of different methods. All of them are valid depending upon the switch application and the circuit. Grayhill uses the method in applicable military specifications. This method specifies an open circuit test voltage and a test current. The voltage drop across the closed contacts is measured. The contact resistance is determined by Ohm's Law from the test current and the measure voltage drop. MIL-DTL-3786, MIL-S-6807 and MIL-S-8805 require a maximum open circuit test voltage of 2 Vdc; they require a test current of 100 milliamperes. MIL-S-83504 requires a maximum test voltage of 50 millivolts and a test current of 10 milliamperes.

When a switch is rated to make and break 5 or more amperes, there is a difference. Contact resistance is determined by measuring the voltage drop while the switch is carrying the maximum rated current.

The voltage drop that occurs across the contacts determines, in part, the contact temperature. If the temperature rise of the contacts is sufficient, it affects contact material. A chemical reaction will take place that can cause an insulating film to appear on the contacts. This film is present between the contacts during the next switching operation. This film formation can cause failure due to increasing contact resistance. For switching of very low voltages and currents, this resistance may be the failure criteria.

## Insulation Resistance

This is the resistance between two normally insulated metal parts, such as a pair of terminals. It is measured at a specific high DC potential, usually 100 Vdc or 500 Vdc. Typical values for new switches are in the range of thousands of megohms. These values usually decrease during switch life. This is a result of build-up of surface contaminants. Typical industry standard "end of life" criteria for the parameter are:

|               |  |
|---------------|--|
| MIL-DTL-3786: | 1000 megohms<br>(for plastic insulation) |
| MIL-S-6807:   | Not specified                            |
| MIL-S-8805:   | 2000 megohms                             |
| MIL-S-83504:  | 1000 megohms                             |

Another special test condition is commonly specified. It measures insulation resistance for switches in a high humidity atmosphere (90%-98% R.H.). In this condition, condensation of moisture commonly occurs on the surface of the insulating material. Some types of insulation will absorb varying amounts of moisture. This will normally lower the insulation resistance. Typical industry values for this condition are:

|               |  |
|---------------|--|
| MIL-DTL-3786: | 10 megohms<br>(for plastic insulation) |
| MIL-S-6807:   | 3 megohms after<br>drying              |
| MIL-S-8805:   | 10 megohms<br>(for plastic material)   |
| MIL-S-83504:  | 10 megohms                             |

## Dielectric Strength

This is the ability of the insulation to withstand high voltage without breaking down. Typical values for new switches in this test are in excess of 1500 Vac RMS. During switch life, contaminants and wear products deposit on the surface of the insulation. This tends to reduce the dielectric withstanding voltage. In testing for this condition, a voltage considerably above rated voltage is applied. Then, the leakage current is measured at the end of life. Typical industry standard test voltages and maximum allowable leakage currents are as follows:

|               |   |
|---------------|---|
| MIL-DTL-3786: | 1000 Vac and 1 mA<br>maximum leakage  |
| MIL-S-6807:   | 600 Vac RMS after life<br>10 microamperes<br>maximum leakage                      |
| MIL-S-8805:   | 1000 or 1000 plus<br>twice working voltage<br>(AC) RMS and 1mA<br>maximum leakage |
| MIL-S-83504:  | 500 Vac and 1 mA<br>maximum leakage   |
| UL Standard:  | 900 Vac without<br>breakdown (UL<br>Standard (dependent<br>on test))              |

Voltage breakdown is another method for

describing the ability of the insulating material to withstand a high voltage. Voltage breakdown describes the point at which an arc is struck and maintained across the insulating surface with the voltage applied between the conducting members.

## ADDITIONAL LIFE FACTORS

### Effect of Loads

On any switch, an arc is drawn while breaking a circuit. This causes electrical erosion of the contacts. This erosion normally increases contact resistance and generates wear products. These wear products contaminate insulating surfaces. This reduces dielectric strength and insulation resistance.

The amount of this erosion is a function of current, voltage, power factor, frequency and speed of operation. The higher the current is, the hotter the arc and the greater the erosion. The higher the voltage is, the longer the arc duration and the greater the erosion.

Inductance acts as an energy storage device. This returns its energy to the circuit when the circuit is broken. The amount of erosion in an inductive circuit is proportionate to the amount of inductance. Industry standard test inductance as described in MIL-I-81023 is 140 millihenries. Other test loads include 250 millihenries and 2.8 henries.

Frequency can also affect erosion. The arcing ends when the voltage passes through zero. To a certain extent, the following is true. The higher the frequency, the sooner arcing ends, the lower the erosion.

The speed of operation affects the duration of the arc. Fast operation can extinguish the arc sooner. This reduces the erosion, unless the air within the switch is completely ionized.

### Actuating Force

Rotational torque is the actuating force required to turn a rotary switch through the various positions. The actual torque or force required depends on the design of the switch. It varies widely from one design to another. See appropriate MIL Specs or manufacturers literature for typical industry values for specific designs.

When torque or force values are specified, it is customary to give a minimum and maximum value. During life, two offsetting factors may occur to change the initial value. Relaxation of spring members will tend to lower torque or force values. Wear or "galling" of mating surfaces, however, may tend to increase these values. Typical end of life specifications may require the switch to fall within the original range. Or, they may specify a maximum percentage change from original value. For example, "the rotational torque shall not change more than 50% from its initial value."

## Effect of Ambient Temperature

Temperature extremes may affect switch performance and life. Very high temperatures may reduce the viscosity of lubricants. This allows them to flow out of bearing areas. This can hasten mechanical wear of shafts, detents, plungers, and cause early mechanical failure. Contact lubricants are sometimes used. Too little lubrication can result in a high rate of mechanical wear. Too much lubrication flowing from other bearing areas can adversely affect dielectric strength and insulation resistance.

Through careful design and selection of lubricants most manufacturers attempt to minimize these affects. Nevertheless, continual operation in high ambient temperatures will shorten the life of a switch regardless of design.

Extremely low ambient temperatures may also create problems. Low temperatures may cause an increase in the viscosity of the contact lubricant. Higher viscosity can delay or prevent the closing of contacts, causing high operating contact resistance. Under certain atmospheric conditions, ice may form on the contact surfaces. This also causes high and erratic contact resistance.

Neither of these conditions may materially reduce the life of the switch. However, it may cause unsatisfactory operation. If the voltage of the circuit is high enough, it can break down the insulating layer. Some current will flow through the high resistance contacts. A local heating action is created, which tends to correct the condition in a short period of time.

Switches with high contact pressures may minimize the low ambient temperature effect. This is particularly true if the application calls for switching signal level voltages and currents.

### Effects of Altitude

In high altitudes, barometric pressure is lower. Low pressure reduces the dielectric strength of the air. The arc strikes at a lower voltage and remains longer. This increases contact erosion. Switches for use in high altitudes will therefore require derating in terms of loads and/or life.

### Effects of Duty Cycle

Mechanical life testers cause accelerated life testing. Testers operate switches at a rate of approximately 10 cycles per minute. This rate is greatly in excess of normal manual operation in equipment. It constitutes a severe test of the switch.

Lubricants do not have an opportunity to redistribute themselves over the bearing surfaces at this duty cycle. The contact heating caused by arcing does not have a chance to dissipate.

Thus, the switch runs "hot", increased mechanical wear and contact erosion result. Your application probably requires manual operation of the switch with an attendant low duty cycle. If so, you can usually expect much longer switch life than is shown by the accelerated life laboratory life tests.

### Conclusion

Remember, load and life ratings are based on manufacturers' selected references. They include accelerated life tests and an arbitrary set of application parameters and failure criteria. These parameters and criteria may not always fit your application.

Then how do you know if a switch will give reliable performance in your application?

How do you know if it will last the life of your equipment?

Ask the switch manufacturer. Grayhill, and most other reputable manufacturers have compiled vast quantities of test data. We are in a position to give a good estimate of a switch's performance in many nonstandard applications. You should provide the following data:

|                   |  |
|-------------------|--|
| Expected Life:    | in number of cycles  |
| Load:             | voltage, current, power factor, and frequency  |
| Operation:        | manual or mechanical, duty cycle   |
| Application:      | type of equipment  |
| Environment:      | altitude, ambient temperature range, relative humidity, corrosive atmosphere, shock, vibration, etc. |
| Failure Criteria: | end of life contact resistance, dielectric strength, insulation resistance, etc.                     |

With this information, we can usually estimate if a given switch is suitable for your application.

### Soldering

What causes failure in a new switch after it has been installed? The principle failure is high contact resistance caused by solder flux on the contact surfaces. To avoid this, be sure to follow good soldering practices. Use the proper solder with the proper flux core, maintain the proper soldering temperature, use the proper soldering iron tip for the work, and never use liquid flux when soldering a switch.

Do not use solvent baths or washes with any unsealed electromechanical parts. Switches, unless they have been especially protected suffer badly. Solvents readily dissolve fluxes and carry them into the contact area of switches. A thin, hard flux coats the contact surface after the solvent evaporates. Additionally, solvents may dissolve and wash away lubricants in switches. Lubricant loss may prevent proper mechanical action.

Exercise similar precautions when you mount a switch to a printed circuit board. Maintain proper solder temperatures and follow proper cleaning techniques. Avoid subjecting these switches to lengthy solder baths. The excessive heat can deform the plastics.

### RFI/EMI Shielding

Some applications require shielding against Radio Frequency Interference and/or Electro-Magnetic Interference. Experts feel that the most effective way to achieve shielding is to provide a conductive bridge across the component mounting hole. They also generally agree that there is no good method for testing shielding. So, the equipment manufacturers themselves must identify and solve specific problems. Component manufacturers can generally assist in the solution of shielding problems.

RFI/EMI testing is incorporated into MIL-DTL-3786 for rotary switches. Requirements are 1.0 ohm maximum dc resistance between the mounting bushing and operating shaft

initially and 10.0 ohm maximum dc resistance following environmental and mechanical tests. Many equipment manufacturers feel they are satisfying their needs with a measurement of .025 to 10 ohms for the expected life of the switch. Under most circumstances, standard non-sealed switches pass the larger value easily. The lower value (.025 ohms) requires special attention and parts for compliance over the life of the switch.

### Switch Selection

Whenever possible, use standard switches and contact configurations. Standards provide the greatest economy and the best delivery. When you need a deviation, it pays to consult with your suppliers as soon as possible. At the early stages of the design, there are many low cost options for achieving the results. At the late stages of design, some of the options may no longer be open. For example, size may be restricted. This might result in a more costly redesign.

Typical standard rotary options are as follows: coded contacts, homing rotor effect, progressively shorting contacts, PC mountable terminals, rotary switch spring return positions, and push-to-turn or pull-to-turn mechanisms.

Limited panel space may be solved by a concentric shaft rotary switch. It is two rotary switches, located one behind the other. There are other concentric shaft possibilities. A rotary switch can be combined with another component. These include a potentiometer, a pushbutton switch, and a mechanical element. The most cost effective design may be one of these concentric options. But, selection must be made at the outset of equipment design.





## 1. SELECT A FACTOR

### FACTOR: Current Life Rating

All switches are rated to make and break at least 100 milliamperes for 10,000 cycles of operation. Rating becomes a matter of interpretation. Carefully review the Engineering Information on the previous pages. Ratings which assure a different life are possible; contact Grayhill.

|                                 | Single Deck Switch Series |    |       |      |      |      |      | Multi-Deck Switch Series |        |        |             |      |
|---------------------------------|---------------------------|----|-------|------|------|------|------|--------------------------|--------|--------|-------------|------|
|                                 | 19                        | 24 | 50/51 | 56   | 75   | 77   | 5000 | 08/09                    | 42/44  | 43/54  | 53,57,59    | 71   |
| 25,000 Cycles At Load (Amps)    | —                         | 1  | .050  | —    | —    | .050 | 1    | .250                     | 1,3,5* | 1,3,5* | —           | .250 |
| 10,000 Cycles At Load (Amps)    | —                         | —  | .200  | .200 | .100 | —    | —    | .500                     | 1,3,5* | 1,3,5* | .150, .250* | —    |
| 6,000 Cycles At Load (Amps, UL) | 15                        | —  | —     | —    | —    | —    | —    | —                        | —      | —      | —           | —    |

\* Varies with angle of throw and style.

### FACTOR: Size

| Maximum Dimension<br>In Inches (& Millimeters) | Single Deck Switch Series |        |        |        |        |        |     |        | Multi-Deck Switch Series |        |        |        |        |        |        |        |
|--|---------------------------|--------|--------|--------|--------|--------|-----|--------|--------------------------|--------|--------|--------|--------|--------|--------|--------|
|  | 19                        | 24     | 50     | 51     | 56     | 75     | 77  | 5000   | 08                       | 09     | 42     | 44     | 53     | 57     | 59     | 71     |
| Diameter, Behind Panel                         | 2.280                     | 1.015  | .500   | .561   | .500   | .298   |     | 1.015  | .687                     | .750   | 1.015  | 1.170  | 1.350  | 1.190  | 1.190  | .750   |
| Length Behind Panel, 1 Deck                    | .950                      | .580   | .698   | .698   | .355   | .500   |     | .470   | .960                     | .960   | 1.025  | 1.025  | .916   | .916   | .916   | .760   |
| Behind Panel, Add'l Deck                       | —                         | —      | —      | —      | —      | —      | —   | —      | .268                     | .268   | .346   | .346   | .329   | .326   | .326   | .218   |
| Diameter, Behind Panel                         | (57,9)                    | (25,8) | (12,7) | (14,2) | (12,7) | (7,6)  | ( ) | (25,8) | (17,4)                   | (19,0) | (25,8) | (29,7) | (34,3) | (30,2) | (30,2) | (19,0) |
| Length Behind Panel, 1 Deck                    | (24,1)                    | (14,7) | (17,7) | (17,7) | (9,0)  | (12,7) | ( ) | (11,9) | (24,4)                   | (24,4) | (26,0) | (26,0) | (23,3) | (23,3) | (23,3) | (19,3) |
| Behind Panel, Add'l Deck                       | —                         | —      | —      | —      | —      | —      | —   | —      | (6,8)                    | (6,8)  | (8,8)  | (8,8)  | (8,4)  | (8,3)  | (8,3)  | (5,5)  |

\* If multi-deck switch is needed, contact Grayhill.

### FACTOR: Circuitry

| Max. Positions<br>1 Deck (1Pole)* | Angle Of<br>Throw | Maximum<br>Decks** | Maximum Poles<br>Per Deck*** | Shorting Or<br>Non-Shorting | Solder Lug<br>Or PC | Series<br>Number |
|-----------------------------------|-------------------|--------------------|------------------------------|-----------------------------|---------------------|------------------|
| 24                                | 15°               | 12                 | 12                           | N or S                      | Solder              | 53               |
| 20                                | 18°               | 12                 | 10                           | N or S                      | Solder              | 59               |
| 16                                | 22°30'            | 12                 | 8                            | N or S                      | Solder              | 57               |
| 16                                | 22°30'            | 1                  | 2                            | N or S                      | Both                | 51               |
| 12                                | 30°               | 12                 | 6                            | N or S                      | Both                | 71               |
| 12                                | 30°               | 12                 | 6                            | N or S                      | Both                | 9                |
| 12                                | 30°               | 12                 | 6                            | N or S                      | Solder              | 44               |
| 12                                | 30°               | 1                  | 4                            | N or S                      | Both                | 51               |
| 12                                | 30°               | 1                  | 4                            | N or S                      | Both                | 56               |
| 11                                | 30°               | 1                  | 1                            | N                           | ****                | 19               |
| 10                                | 36°               | 12                 | 2                            | N or S                      | Both                | 8                |
| 10                                | 36°               | 12                 | 2                            | N or S                      | Both                | 71               |
| 10                                | 36°               | 12                 | 2                            | N or S                      | Both                | 42               |
| 10                                | 36°               | 1                  | 2                            | N                           | PC                  | 75/77            |
| 10                                | 36°               | 1                  | 2                            | N or S                      | Both                | 50               |
| 10                                | 36°               | 1                  | 2                            | N or S                      | Both                | 56               |
| 10                                | 36°               | 1                  | 1                            | N or S                      | Both                | 24               |
| 10                                | 36°               | 1                  | 1                            | N or S                      | Solder              | 5000             |
| 8                                 | 45°               | 12                 | 4                            | N or S                      | Both                | 9                |
| 8                                 | 45°               | 12                 | 4                            | N or S                      | Solder              | 44               |
| 8                                 | 45°               | 1                  | 2                            | N                           | Both                | 50               |
| 6                                 | 60°               | 6                  | 3                            | N                           | Both                | 9                |
| 6                                 | 60°               | 12                 | 3                            | N                           | Solder              | 44               |
| 6                                 | 60°               | 1                  | 2                            | N                           | Both                | 50               |
| 4                                 | 90°               | 12                 | 2                            | N                           | Solder              | 44               |
| 4                                 | 90°               | 6                  | 2                            | N                           | Both                | 9                |
| 4                                 | 90°               | 1                  | 2                            | N                           | Both                | 50               |

\* Maximum positions per pole depends on number of poles per deck.

\*\* Based on 1 pole per deck. Number of decks is also limited by the total number of poles.

\*\*\* Limited by total number of poles per switch.

\*\*\*\*Choice of Faston or Solder Lug terminals.



## Rotary Switch Standard Options

- Custom Switches With No Tooling Required
- Easily Ordered Specials

### 1. Dummy Terminal

Used as tie point, it is not an active switch position. Can be located at any specified position outside of active switch terminals. Priced as active position. Example, a three position switch with 2 dummy terminals would be priced as a five position switch.

### 2. Enlarged Wire Holes

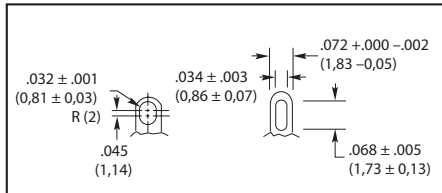

Series 08A, 09A, 42H, 42M, 44H, and 44M: Lug terminals for several wires; standard in Series 08M, 09M, 53, 57, and 59 switches.

### 3. High Density Wiring Terminal

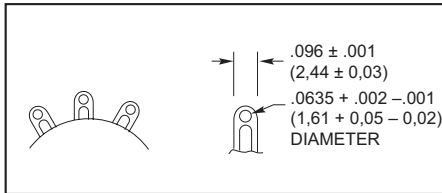

The gold-plated terminal features a slot to accept wires in addition to the conventional wire hole.

### 4. Taper Tab Terminals

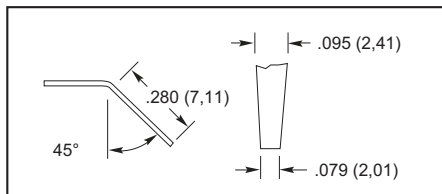

Used in place of conventional solder lug terminals. Taper tab terminals are gold plated.

### 5. Notched Terminals

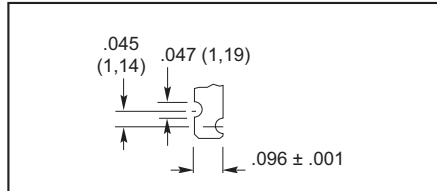

Used in place of the conventional solder lug terminals.

### 6. External Shorting Links

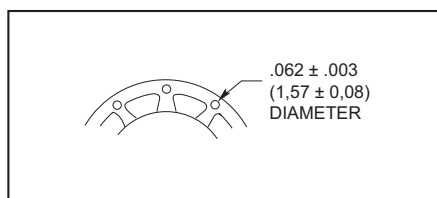

External shorting links, as shown in the drawing, can be used in place of conventional solder lug terminals in the Series 5000, 24, 42 or 43 rotary switches. Shorted terminals can also be accomplished internally in the Series 71 rotary switches. Solder lug terminals can be intermixed on the same deck.

### 7. Non-Standard, Non-Turn Devices

**Switches without tabs**  
Series 08, 09, 42 and 44: There is no additional charge for a front support plate without a non-turn tab.

### Non-turn tab of non-standard projection Series 08:

All tabs located at .260 inch radius from centerline of switch. The following projections (inches) are available: .121; .094; .045; .032  
Series 44:

| From Centerline  | Projection                       |
|------------------|----------------------------------|
| .375" (9,53 mm)  | .062" (1,57 mm)                  |
| .531" (13,49 mm) | .121" or .049" (3,07 or 1,24 mm) |

### 8. RF1 Grounding

A silver-plated shaft and wave washer improve DC grounding of shaft to mounting bushing, thus minimizing possible radio frequency interference. Example: static and dynamic DC resistance after 25,000 cycle life test is maximum 100 milliohms. For concentric shaft switches, discuss grounding with factory. Special handling charges apply to small lots.

### 9. Electrostatic, Electromagnetic Shielding

A metallic shield can be added between decks. Grounding of the shield provides additional RFV /EMI protection. Size and shape of the shield depends on the equipment configuration and the amount of protection required Price is dependant on the number and type of shields required.

### 10. Unidirectional Rotation

The detenting system permits rotation in only one direction. Usable only with continuous rotation switches. Specify direction of rotation. Applicable to 30° and 36° throw switches only.

| Switch Series# | Options For Styles A and S |    |   |   |   |   |   |    | Options For All Styles |    |    |    |    |    |    |    |
|----------------|----------------------------|----|---|---|---|---|---|----|------------------------|----|----|----|----|----|----|----|
|                | 1                          | 2  | 3 | 4 | 5 | 6 | 7 | 8  | 9                      | 10 | 11 | 12 | 13 | 14 | 15 | 16 |
| 08             | x                          | x  |   |   |   |   | x | x  |                        |    | x  | x  |    |    |    |    |
| 09             | x                          | x  |   |   |   |   | x | x  |                        |    | x  | x  |    |    |    |    |
| 24             | x                          |    | x | x | x | x |   | x  |                        |    |    |    |    |    |    |    |
| 42             | x                          | x* | x | x | x | x | x | x  | x                      | x  | x  | x  |    |    |    |    |
| 43             | x                          |    | x | x | x | x |   | x* |                        |    | x  |    |    | x  | x  |    |
| 44             | x                          | x* | x | x | x |   | x | x  | x                      | x  | x  |    | x  |    |    |    |
| 50/51          |                            |    |   |   |   |   |   | x  |                        |    | x  |    |    |    |    |    |
| 56             |                            |    |   |   |   |   |   | x  |                        |    | x  |    |    |    |    |    |
| 53/57/59       |                            |    |   |   |   |   |   | x  |                        |    |    |    |    |    |    |    |
| 54             | x                          |    | x | x | x |   |   | x* |                        |    | x  |    |    | x  | x  | x  |
| 71             |                            |    |   |   |   |   |   | x* | x                      |    | x  |    |    |    |    |    |
| 5000           | x                          |    | x | x | x | x |   | x  |                        |    |    |    |    |    |    |    |

\* See description below for limitations.





### 11. Intermixing of Shorting and Non-Shorting Contacts

In some switches, non-shorting and shorting contacts can be intermixed between decks. A 2-deck switch, for example could have shorting contacts on deck 1 and non-shorting contacts on deck 2. In a few switches, non-shorting and shorting contacts can also be intermixed between poles. A 2-pole per deck switch, for example, could have non-shorting on pole #1, and shorting on pole #2.

Series 08 and 09:

An 09M30 or 08M36 rotary switch can have shorting and non-shorting contacts intermixed between decks. Shorting and non-shorting contacts can be intermixed between poles as well as decks in styles A, S, P, and SP.

Series 42, 43, 44, and 54, in 30° or 36°:

Non-shorting and shorting contacts can be intermixed between poles or decks.

Series 50, 51, and 56:

Non-shorting and shorting contacts can be intermixed between poles.

Series 71:

Non-shorting and shorting contacts can be intermixed between poles in fixed stop switches only.

Priced the same as standard switches. The type of contacts on each pole must be precisely indicated.

### 12. PC Mount Switches With Terminals From One Side of Switch

Series 71 PC mount switch has all terminals on one side.

Series 08P, 09P, and 42P with non-shorting contacts are also available with terminals limited to one side. Contact Grayhill for a special part number. This is accomplished by using 2 decks per pole and placing the rotating contacts 180° out of phase on each deck. The first deck picks up the first half of the positions; the second deck picks up the last half of the positions. Common terminals are tied together by the PC board circuitry.

A total of 12 decks (6 usable poles) is the maximum per switch. Switches with the maximum number of positions (12 for 30°, or 10 for 36°) will have continuous rotation. Rotation can be limited to less than the maximum positions. For example, an 8 position Series 8P36 switch with terminals on one side, would pick up 5 positions on the first deck and 3 positions on the second deck.

Price is the same as standard switches with comparable number of decks and positions.

Example: an 08P36, 1-pole, 10 position switch with terminals on one side of the switch would be priced as a 2 deck, five position, one pole per deck switch.

### 13. Homing Rotor (Bridging and Shorting Deck) and Progressively Shorting Deck - Series 44 only

A homing rotor (bridging and shorting) switch deck connects all terminals to the common except the terminal in the selected switch position. For example, in position 1, terminals 2 thru 12 are

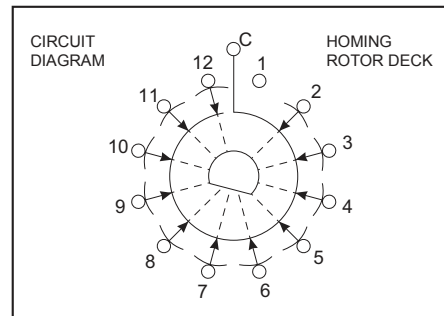

connected to the common, and terminal 1 is open. In position 2, terminal 3 thru 12 and 1 are connected to the common, and terminal 2 is open. A homing rotor deck will function for 25,000 mechanical cycles of operation.

The progressively shorting switch deck connects consecutive switch positions to the common. For example, in position 1, terminal 1 is connected to the common; in position 2, terminals 1 and 2 are connected to the common; in position

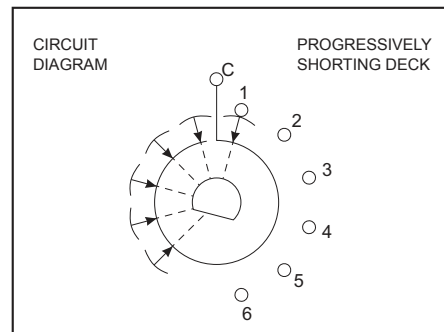

3, terminals 1, 2, and 3 are connected to the common. A progressively shorting deck is limited to a maximum of 6 positions. A progressively shorting deck will function for 25,000 mechanical cycles of operation.

Homing Rotor or Progressively Shorting decks can be ordered as a deck of a 44A or 44M style switch, or their sealed equivalents. Order up to 11 conventional decks and 1 special circuitry deck. For a good detent feel, the switch is limited to a total of 12 poles plus the homing rotor or progressively shorting deck. Example: 6 2-pole decks and a homing rotor. When these special

decks are used in combination with conventional decks, it is important to remember that the stop system limits the rotation of both types of decks. For example, when a homing rotor deck is used in combination with a 6-position conventional deck, the homing rotor is likewise limited to six positions.

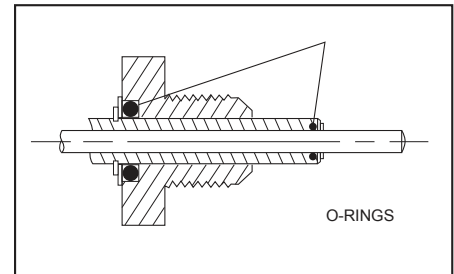

### 14. Shaft and Panel Seal on Concentric Shaft Switches

The following diagram shows the location of the O-rings required to seal the shafts to the bushings. When the concentric shaft switches are sealed in this manner, the .125 inch diameter shaft is supplied full round. Bushing-to-panel sealing is accomplished by the panel seal kit.

### 15. Fixed Stop, Add-A-Pot Switches

The rotary switch section of the Add-A-Pot rotary switches can be built with a fixed mechanism rather than the standard adjustable stop mechanism. The front end of a switch of this type is similar to the Series 43A or Series 54A style concentric rotary switches. The total number of decks is limited to three. The Series 43 is limited to 1 pole per deck. Series 54 to 2 poles per deck.

### 16. Series 54 Concentric Shaft Switch in 45°, 60°, and 90° Throws

The Series 54A switch is available with these angles of throw in Section A of the concentric rotary switch. Section B is available in 30° angle of throw only. Section A is limited to 1 to 3 decks, non-shorting contacts, and 1 or 2 poles per deck.