

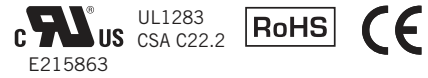

EMI/RFI DC Filter with very high attenuation for DC industrial and residential applications

Datasheet 3/2019

APPROVALS:



SCCR by UL508A



FIN1220.(005 - 280).V

FEATURES

- Rated current from 5 to 3000A
- Very high common mode attenuation
- Very low leakage current

BENEFITS

- 5 Year warranty
- Various connections available
- Finger safe protection available



FIN1220.(280 - 1750).B

MARKETS

- Renewable energy
- Recharging stations
- AC/DC converters
- Single phase machines up to 700 Vac

ORDERING CODE

FIN1220	.100	.V
Model	Current (A)	Connection
		V = Screw
		B = Bus bar



FIN1220.(2000 - 3000).B

ATTENUATION INDICATOR

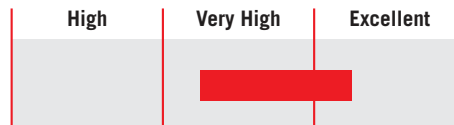

ELECTRIC DIAGRAM

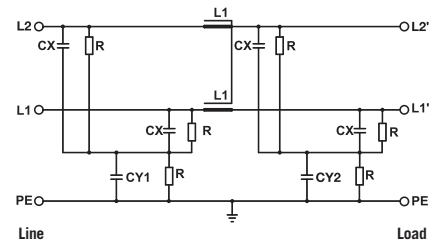

TECHNICAL SPECIFICATIONS

Nominal voltage	0 / 1000 Vdc - 0 / 700 Vac
Frequency	50 – 60 Hz
Rated current	5 to 3000A
Potential test voltage phase to phase	3100 Vdc (2 sec.)
Potential test voltage phase to ground	3400 Vdc (2 sec.)
Leakage current normal conditions	< 3 mA *
Leakage current worst conditions	< 10 mA
IP Protection	IP20 up to 280A IP00 over 280A IP20 available with protection FINPRT
Overload capability	4 x Rated current (Switch ON) 2 x In 10 seconds 1.5 In for 10 minutes
Climatic class	-40 / +85° C
MTBF at 40°C	250.000 Hrs

* Voltage 230 Vac phase to ground 50Hz / 40°C

ELECTRICAL CHARACTERISTICS

FIN1220	Rated Current 40°C	Rated Current 50°C	Power Loss (W)
.005.V	5	4	5
.010.V	10	8	7
.016.V	16	14	14
.030.V	30	27	11
.050.V	50	46	10
.080.V	80	75	39
.100.V	100	90	45
.130.V	130	110	49
.150.V	150	140	69
.180.V	180	165	77
.200.V	200	190	85
.250.V	272	250	87
.280.V	297	280	77
.280.B	330	320	76
.320.B	330	320	77
.360.B	390	360	98
.400.B	435	400	102
.500.B	545	500	96
.600.B	654	600	102
.750.B	800	750	88
.900.B	940	900	72
.1000.B	1050	1000	102
.1250.B	1290	1250	96
.1500.B	1550	1500	108
.1600.B	1650	1600	115
.1750.B	1800	1750	120
.2000.B	2050	2000	122
.2250.B	2300	2250	127
.2500.B	2550	2500	140
.3000.B	3000	2950	150

CONNECTIONS

LINE		PE	
d (mm)	Torque (Nm)	d1 (mm)	Torque (Nm)
M4	1.2	M4	1.2
M4	1.2	M4	1.2
M5	4	M5	4
M5	4	M5	4
M6	6	M5	4
M8	14	M8	14
M8	14	M8	14
M10	18	M10	18
M10	18	M10	18
M10	18	M10	18
M10	18	M10	18
M12	20	M10	18
M12	20	M10	18
M8	14	M10	18
M8	14	M10	18
M8	14	M10	18
M8	14	M10	18
M10	25	M10	18
M10	25	M10	18
M12	50	M12	20
M12	50	M12	20
M12	50	M12	20
M12	50	M12	20
M12	50	M12	20
M12	50	M12	20
M12	50	M12	20
M12	50	M12	20
M12	50	M12	20
M12	50	M12	20

TYPICAL ATTENUATION

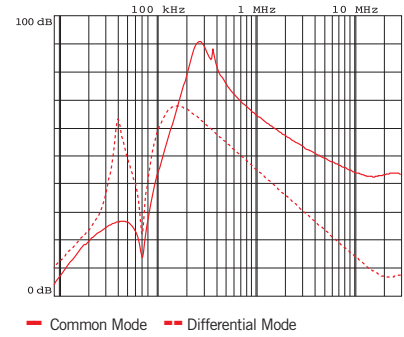

Typical attenuation 7A – 400A

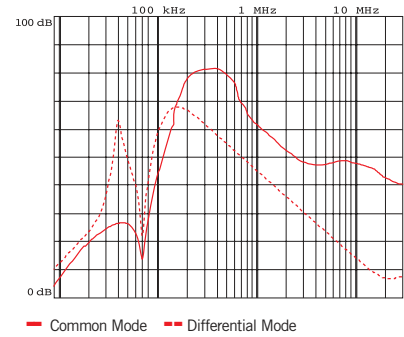

Typical attenuation 500A – 3000A

MECHANICAL DIMENSIONS mm

FIN1220	A	B	C	d	d1	V	F	H	I	L	N	P	S	Weight Kg.	Case
.005.V	58	86	44	M4	M4	14	4.5	186	160	176	30	40	38	2	1
.010.V	58	86	44	M4	M4	14	4.5	186	160	176	30	40	38	2	1
.016.V	90	100	46	M5	M5	28	4.5	246	220	235	35	70	64	3	2
.030.V	90	100	46	M5	M5	28	4.5	246	220	235	35	70	64	3	2
.050.V	90	100	46	M6	M6	28	4.5	246	220	235	35	70	64	3	3
.080.V	90	100	40	M8	M8	28	4.5	246	220	235	35	70	69	3	4
.100.V	90	100	40	M8	M8	28	4.5	246	220	235	35	70	69	3	4
.130.V	90	185	120	M10	M10	29	6.5	356	320	340	77.5	70	60	5	5
.150.V	90	185	120	M10	M10	29	6.5	356	320	340	77.5	70	60	5	5
.180.V	90	185	120	M10	M10	29	6.5	356	320	340	77.5	70	60	5	5
.200.V	90	185	120	M10	M10	29	6.5	356	320	340	77.5	70	60	5	5
.250.V	90	220	120	M12	M12	30	6.5	356	320	340	95	70	60	7.5	6
.280.V	90	220	120	M12	M12	30	6.5	356	320	340	95	70	60	7.5	6

CASE 1, 2, 3, 4

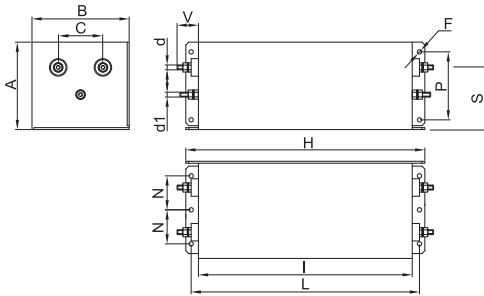

ASSEMBLY CONNECTION "V"

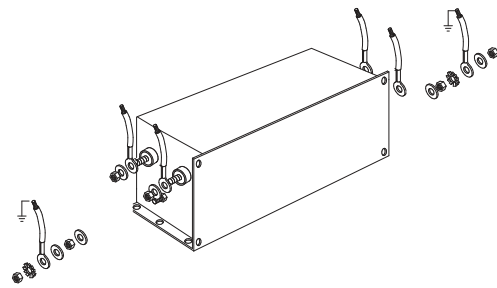

CASE 5, 6

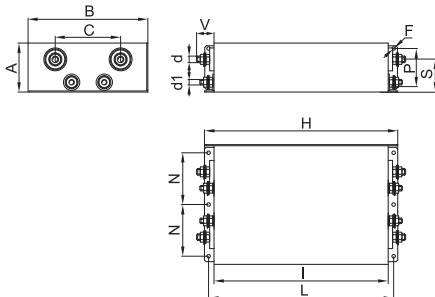

ASSEMBLY CONNECTION "V"

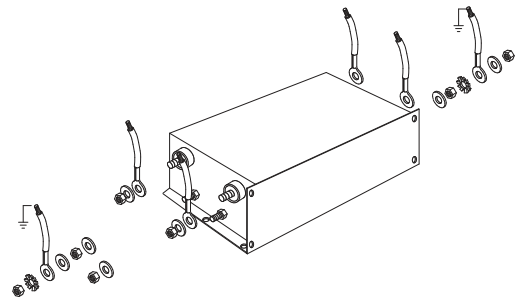

MECHANICAL DIMENSIONS mm

FIN1220	A	B	C	d	d1	d2	d3	V	F	H	I	L	N	N1	P	S	Weight Kg.	Case
.280.B	90	220	120	M8	M10	6	20	42	6.5	356	320	340	50	190	70	55	7.5	7
.320.B	90	220	120	M8	M10	6	20	42	6.5	356	320	340	50	190	70	55	7.5	7
.360.B	130	230	150	M8	M10	10	25	42	6.5	420	380	400	70	200	85	85	10	8
.400.B	130	230	150	M8	M10	10	25	42	6.5	420	380	400	70	200	85	85	10	8
.500.B	130	230	150	M8	M10	10	25	42	6.5	420	380	400	70	200	85	85	10	8
.600.B	130	230	150	M10	M10	15	30	48	6.5	510	450	480	70	200	100	85	15.5	9
.750.B	130	230	150	M10	M10	15	30	48	6.5	510	450	480	70	200	100	85	15.5	9
.900.B	160	250	140	M12	M12	20	40	94	8.5	510	450	480	70	200	110	110	23	10
.1000.B	160	250	140	M12	M12	20	40	94	8.5	510	450	480	70	200	110	110	23	10
.1250.B	160	250	140	M12	M12	20	40	94	8.5	510	450	480	70	200	110	110	23	10
.1500.B	180	300	200	M12	M12	20	60	97	8.5	560	500	530	80	250	130	117	27	11
.1600.B	180	300	200	M12	M12	20	60	97	8.5	560	500	530	80	250	130	117	27	11
.1750.B	180	300	200	M12	M12	20	60	97	8.5	560	500	530	80	250	130	117	27	11
.2000.B	225	350	200	M12	M12	25	80	100	8.5	610	550	580	150	-	-	112.5	45	12
.2250.B	225	350	200	M12	M12	25	80	100	8.5	610	550	580	150	-	-	112.5	45	12
.2500.B	225	350	200	M12	M12	25	80	100	8.5	610	550	580	150	-	-	112.5	45	12
.3000.B	225	350	200	M12	M12	25	80	100	8.5	610	550	580	150	-	-	112.5	45	12

CASE 7, 8, 9

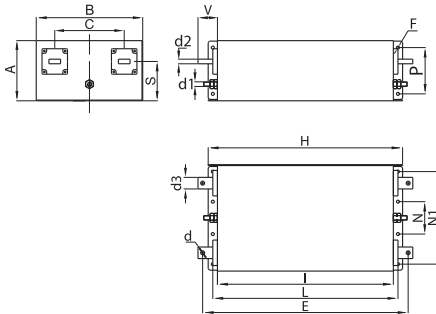

ASSEMBLY CONNECTION "B"

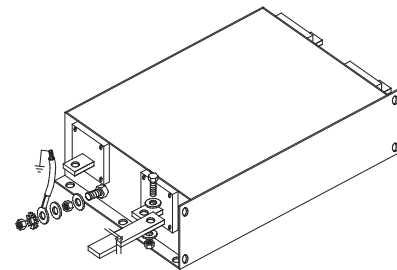

CASE 10, 11

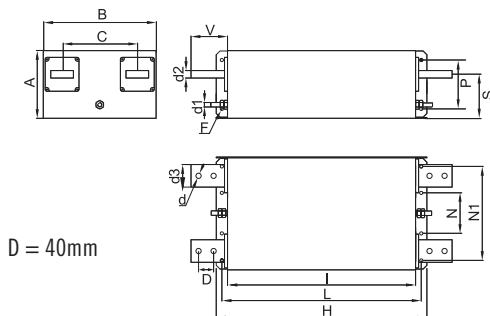

ASSEMBLY CONNECTION "B"

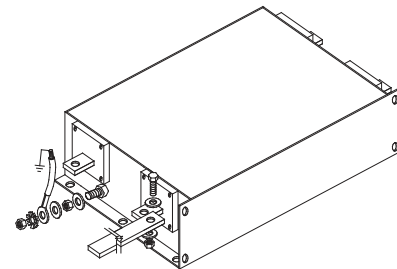

CASE 12

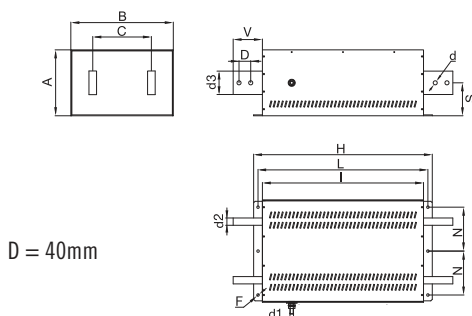

ASSEMBLY CONNECTION "B"

