

FEATURES

- Reduces Systemic EMI.
- Modulates external clocks including crystals, crystal oscillators and ceramic resonators.
- 3 - 5 Volt power supply.
- Modulation programmable with simple external loop filter (LF).
- 4 to 68 MHz operating frequency range.
- Digitally controlled modulation.
- TTL/CMOS compatible outputs.
- Center Spread Modulation.
- Low short term jitter.
- Bi-Directional buffers for reduced pin count.
- Unmodulated Reference Clock Output.
- Low Power Dissipation;
 - 3.3 VDC = 21 mw - typical
 - 5.0 VDC = 70 mw - typical
- Available in 8 pin SOIC package.

APPLICATIONS

- Desktop/Laptop Computer
- Modems
- Scanners, Printers, Copiers, Fax Machines, MFP's
- Disk and CD-ROM Drives
- Automotive and Embedded Systems
- Networking, LAN/WAN
- Digital Cameras, Games
- LCD displays

BENEFITS

- Reduction of radiated EMI
- Fast Time to Market
- Lower cost of compliance
- Programmable EMI reduction
- No degradation in Rise/Fall times
- Lower component and PCB layer count

PRODUCT DESCRIPTION

The IMI FS741 is a Frequency Spreading EMI Attenuator designed for the purpose of reducing Electro Magnetic Interference (EMI) found in today's high speed digital systems. The FS741 uses a proprietary technique to modulate the output clock frequency, Modout. By modulating the frequency of the digital clock, measured EMI at the fundamental and harmonic frequencies is greatly reduced. This reduction in radiated energy can significantly reduce the cost of complying with regulatory requirements without degrading digital waveforms.

The IMI FS741 is a very simple device to use. By programming the two range select lines, RS0 and RS1, the FS741 can operate over a very wide range of input frequencies. By utilizing IMI's Bi-Directional Buffer design, the pin count of the FS741 is kept to a minimum. Bi-Directional Buffers is a method of providing an input control signal and an output driver circuit on the same pin. Bi-Directional Buffers is discussed further on page 6. The FS741 also provides a buffered reference clock output, Refout, which can be turned on or off by controlling the Ref_Off pin. The Refout clock can be used to drive system logic that can not tolerate Frequency Spreading, or as a comparison of EMI reduction with respect to the Modout driver. The FS741 has a simple frequency selection table that allows it to operate from 4 MHz to 68 MHz in four separate ranges. The bandwidth of the frequency spread at Modout is determined by the values of the loop filter components. The modulation rate is determined by the input frequency and the input frequency range selected. The bandwidth of the FS741 can be programmed from as little as 0.3% up to as much as 4.0% by selecting the proper loop filter. It is for this reason that the FS741 uses an external loop filter (LF), in contrast to an internal loop filter type device which would severely limit the use of a wide range of bandwidths.

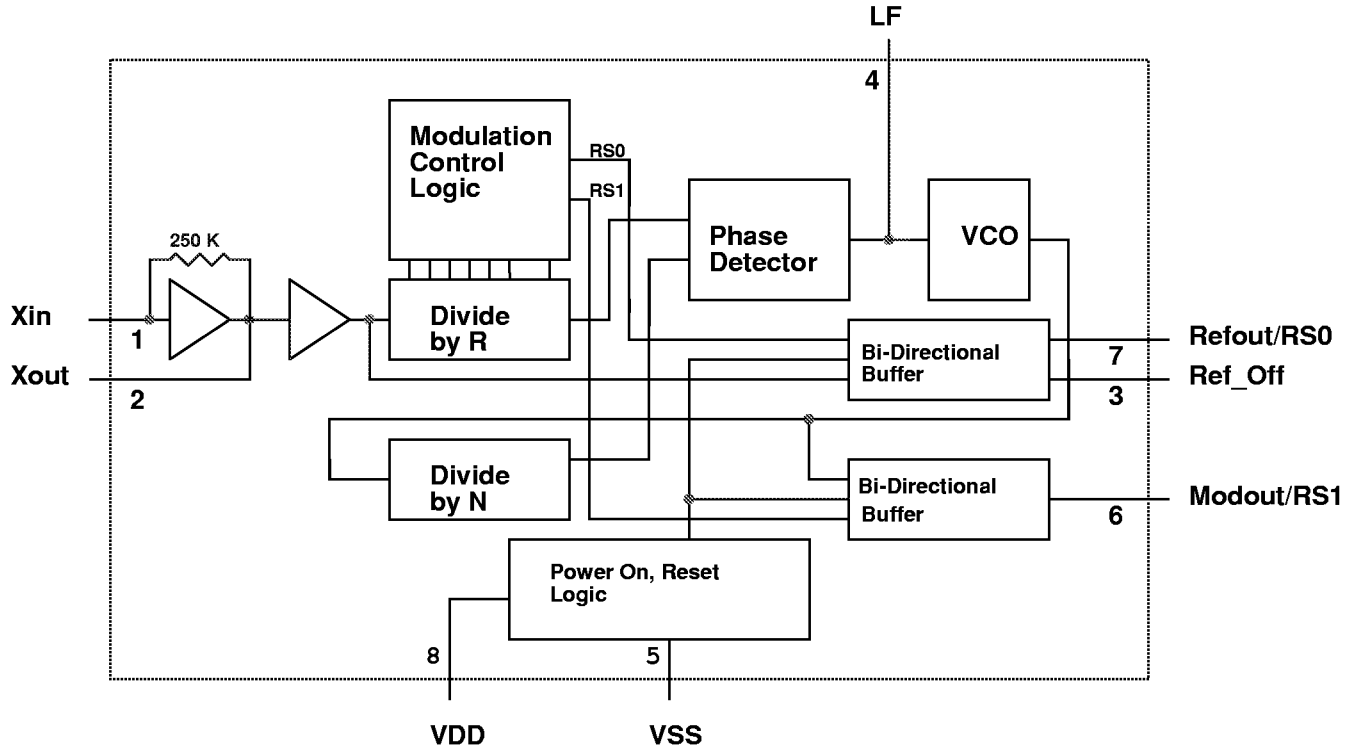
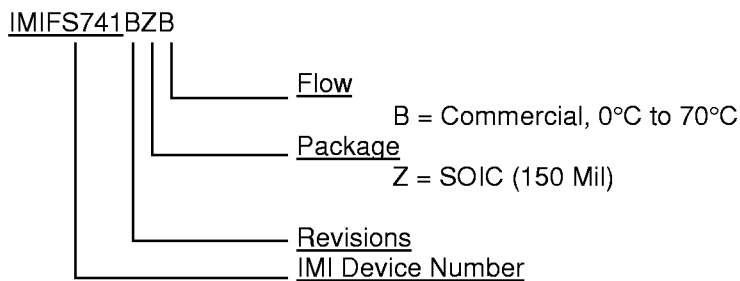

Figure 1. Block Diagram

ORDERING INFORMATION

Part Number	Package Type	Production Flow
IMIFS741BZB	8 Pin SOIC	Commercial, 0°C to 70°C

Marking Example: IMI Date Code
FS741BZB
Lot Number



CONNECTION DIAGRAM

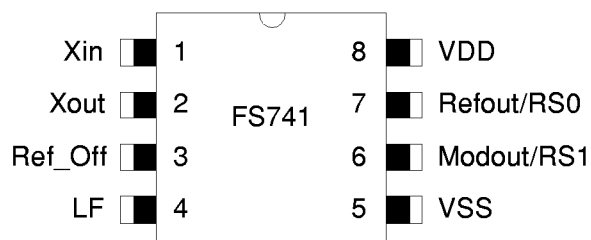

Figure 2. FS741, SOIC Package Pin Assignment

<i>Pin Descriptions</i>				
Pin No.	Pin Name	I/O	TYPE	Description
1, 2	Xin, Xout	I/O	CMOS/TTL	Pins form an on-chip reference oscillator when connected to terminals of an external parallel resonant crystal. Xin may be connected to TTL/CMOS external clock source. If Xin is connected to an external clock other than a crystal, leave Xout (pin 2) unconnected.
3	Ref_Off	I	CMOS/TTL	Input control pin determines the on/off state of Refout. Ref_Off has an internal pull down resistor and defaults to Refout = Off. To enable Refout, set Ref_Off to logic high.
4	LF	O	Analog	Single ended tri-state output of the phase detector. A two pole passive loop filter is connected to LF. See tables on page 7 and 8 for proper values.
5	VSS	-	Ground	Circuit Ground.
6	Modout/RS1	I/O	CMOS/TTL	Bi-Directional pin used for range selection input and Modout driver output. During power up, RS1 serves as an input control line for selecting the proper frequency operating range. After RS1 is latched into an internal register, this pin becomes an output for the Modout driver. Refer to page 6 for explanation on Bi-Directional buffers. Modout/RS1 has an internal 250 K Ω pull-up resistor to VDD.
7	Refout/RS0	I/O	CMOS/TTL	Bi-Directional pin used for range selection input and Refout driver output. During power up, RS0 serves as an input control line for selecting the proper frequency operating range. After power has reached VDD/3, RS0 is latched into a register and this pin becomes an output pin for the Refout driver. Refout is tri-stated when Ref_Off is at a logic low.
8	VDD	-	Power	Positive Circuit Power Supply.

Table 1

Frequency Range Selection Table		
Xin RANGE	RS1	RS0
4 - 8 MHz	0	0
8 - 16 MHz	0	1
16 - 40 MHz	1	0
40 - 68 MHz	1	1

Table 2

This device contains circuitry to protect the inputs against damage due to high static voltages or electric fields; however, precautions should be taken to avoid application of any voltage higher than the absolute maximum rated voltages to this circuit. For proper operation, V_{in} and V_{out} should be constrained to the range, $V_{SS} < (V_{in} \text{ or } V_{out}) < V_{DD}$. Refer to electrical specifications for operating supply range.

Absolute Maximum Ratings				
Item	Symbol	Min.	Max.	Units
Operating Voltage	VDD	3.0	6.0	VDC
Input, relative to VSS	VIRvss	-0.3	VDD +0.3	VDC
Output, relative to VSS	VORvss	-0.3	VDD +0.3	VDC
Temperature, Operating	TOP	0	+ 70	^o C
Temperature, Storage	TST	- 65	+ 150	^o C

Table 3

Electrical Characteristics						
Characteristic	Symbol	Min.	Typ.	Max.	Units	
Input Low Voltage	VIL	-	-	0.8	VDC	
Input High Voltage	VIH	2.0	-	-	VDC	
Input Low Current	IIL	-	-	100	μ A	
Input High Current	IIH	-	-	100	μ A	
Output Low Voltage IOL= 8mA, VDD = 5V	VOL	-	-	0.4	VDC	
Output High Voltage IOH = 8mA, VDD = 5V	VOH	VDD-1.0	-	-	VDC	
Output Low Voltage IOL= 5mA, VDD = 3.3V	VOL	-	-	0.4	VDC	
Output High Voltage IOH = 3mA, VDD = 3.3V	VOH	2.4	-	-	VDC	
Input Capacitance (Pin-1)	C _{in1}	-	3	4	pF	
Output Capacitance (Pin-2)	C _{in2}	-	5	6	pF	
Tri-State Leakage Current (pin 7)	IOZ	-	-	5.0	μ A	
5 Volt Dynamic Supply Current (Operating mode)	I _{dd}	-	14	17	ma	
3.3 Volt Dynamic Supply Current (Operating mode)	I _{dd}	-	6.3	7.5	ma	
Short Circuit Current (Refout or Modout)	ISC	-	-	25	ma	

Test measurements performed at VDD = 3.3V and 5.0V \pm 10%, Xin = 30 MHz, Ta = 0°C to 70°C

Table 4

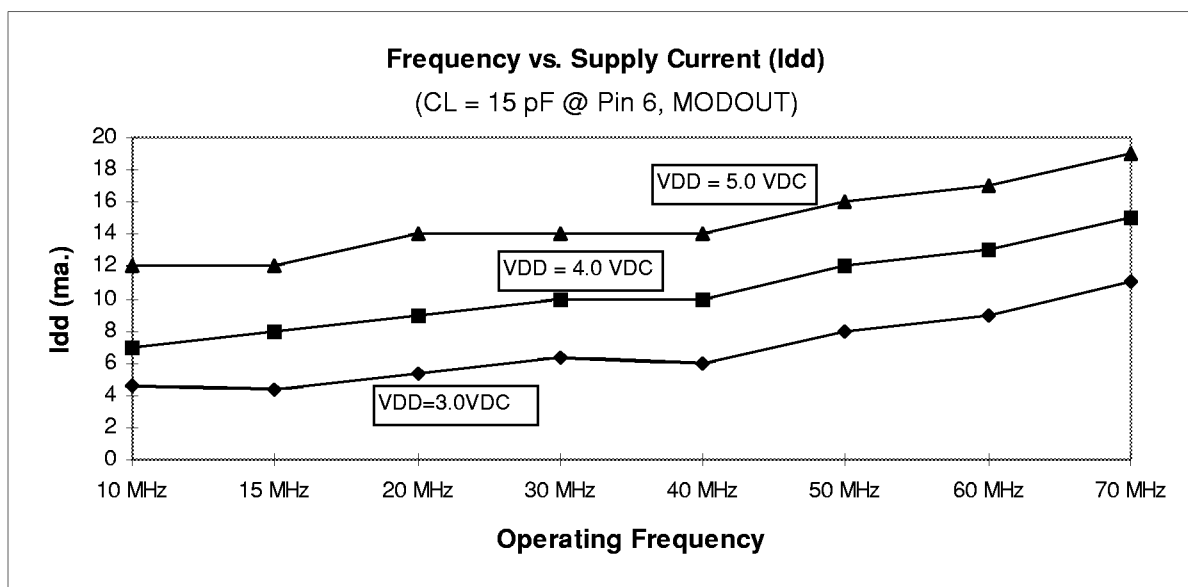

Timing Characteristics					
Characteristic	Symbol	Min	Typ	Max	Units
Output Rise Time Measured at 10% - 90% @ 5 VDC	t _{TLH}	4.5	5.1	5.7	ns
Output Fall Time Measured at 10% - 90% @ 5 VDC	t _{THL}	4.0	4.3	4.7	ns
Output Rise Time Measured at 0.8V - 2.0V @ 5 VDC	t _{TLH}	850	900	975	ps
Output Fall Time Measured at 0.8V - 2.0 V @ 5 VDC	t _{THL}	1.3	1.4	1.5	ns
Output Rise Time Measured at 10% - 90% @ 3.3 VDC	t _{TLH}	5.0	5.3	5.9	ns
Output Fall Time Measured at 10% - 90% @ 3.3 VDC	t _{THL}	4.8	5.1	5.4	ns
Output Rise Time Measured at 0.8V - 2.0V @ 3.3 VDC	t _{TLH}	1.8	1.9	2.0	ns
Output Fall Time Measured at 0.8V - 2.0 V @ 3.3 VDC	t _{THL}	2.0	2.2	2.4	ns
Output Duty Cycle	T _{symF1}	45	50	55	%
Peak-to-Peak Jitter One Sigma	t _{j1s}	-	150	250	ps

Measurements performed at VDD = 3.3 and 5.0V ± 10%, Ta = 0°C to 70°C, CL = 15pF, Xin = 30 MHz.

Table 5

BI-DIRECTIONAL BUFFERS

Two pins on the FS741 are connected to Bi-Directional buffers. Using Bi-Directional buffers is a method of sharing an input circuit and an output circuit with the same pin on the IC assembly, thereby reducing the pin count. Each Bi-Directional I/O acts as an input during power up and as an output after power has reached a certain voltage. For the FS741, that voltage is approximately $V_{DD}/3$. At $V_{DD}/3$, the FS741 latches the logic state of the respective line into an internal register for as long as power is applied to the FS741. After $V_{DD}/3$ has been reached and the power on reset has occurred, the respective pin is switched from an input gate to an output driver. This pin remains an output driver for as long as power is applied.

Loop Filters

The FS741 requires an external loop filter to provide the proper operation and bandwidth for a given input frequency. Since the FS741 operates over a wide range of frequencies, the loop filter will change depending on the frequency of operation. The following loop filter values are recommended for best performance and modulation profile at 5.0 volts and 3.3 volts V_{DD} , measured across pin 8 (V_{DD}) and 5 (V_{SS}).

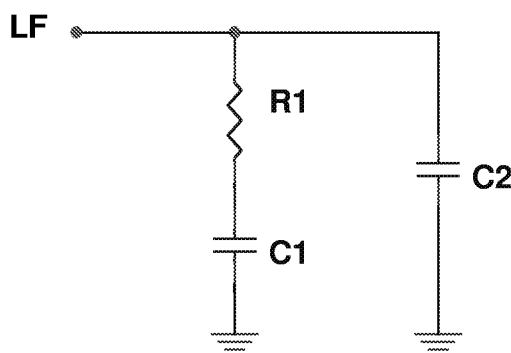

Figure 4.

The tables on pages 7 and 8 contain the loop filter values for the power supply voltages of 5.0 and 3.3 VDC, +/- 10%. The values in both tables 6 and 7 were bench tested for accuracy and optimal performance. The loop filter values were determined by taking 4 MHz segments of the overall operating range and testing for the optimal performance at the center frequency of each 4 MHz band. This means that in the first band in the table below, 4 - 8 MHz, the loop filter values shown in the table produce the most optimized performance for 6 MHz. It is possible to deviate slightly from these values for optimal performance at some other center frequency. Also note that the values listed in these tables are all commonly manufactured components.

Recommended Loop Filter Values (VDD = 5.0 VDC, +/- 10%)						
Input (MHz)	RS1	RS0	BW = 1% (+/- .5%)	BW = 2% (+/- 1%)	BW = 3% (+/- 1.5%)	BW = 4% (+/- 2%)
4-8	0	0	R1=2.2K C1=270pF C2=22pF	R1=2.2K C1=120pF C2=22pF	R1=2.2K C1=82pF C2=22pF	R1=2.2K C1=56pF C2=22pF
8-12	0	1	R1=2.2K C1=470pF C2=22pF	R1=2.2K C1=220pF C2=22pF	R1=2.2K C1=150pF C2=22pF	R1=2.2K C1=100pF C2=22pF
12-16	0	1	R1=2.2K C1=180pF C2=22pF	R1=2.2K C1=82pF C2=22pF	R1=2.2K C1=56pF C2=22pF	R1=2.2K C1=33pF C2=22pF
16-20	1	0	R1=2.2K C1=680pF C2=22pF	R1=2.2K C1=330pF C2=22pF	R1=2.2K C1=220pF C2=22pF	R1=2.2K C1=150pF C2=22pF
20-24	1	0	R1=2.2K C1=470pF C2=22pF	R1=2.2K C1=220pF C2=22pF	R1=2.2K C1=150pF C2=22pF	R1=2.2K C1=100pF C2=22pF
24-28	1	0	R1=2.2K C1=220pF C2=22pF	R1=2.2K C1=100pF C2=22pF	R1=2.2K C1=82pF C2=22pF	R1=2.2K C1=56pF C2=22pF
28-32	1	0	R1=4.7K C1=220pF C2=0pF	R1=4.7K C1=100pF C2=0pF	R1=4.7K C1=68pF C2=0pF	R1=4.7K C1=47pF C2=0pF
32-36	1	0	R1=4.7K C1=120pF C2=0pF	R1=4.7K C1=68pF C2=0pF	R1=4.7K C1=47pF C2=7pF	R1=4.7K C1=27pF C2=15pF
36-40	1	0	R1=4.7K C1=100pF C2=0pF	R1=4.7K C1=33pF C2=0pF	R1=4.7K C1=27pF C2=0pF	R1=4.7K C1=18pF C2=0pF
40-44	1	1	R1=2.2K C1=470pF C2=0pF	R1=2.2K C1=180pF C2=22pF	R1=2.2K C1=120pF C2=22pF	R1=2.2K C1=82pF C2=22pF
44-48	1	1	R1=2.2K C1=330pF C2=0pF	R1=2.2K C1=150pF C2=22pF	R1=2.2K C1=120pF C2=16pF	R1=2.2K C1=82pF C2=10pF
48-52	1	1	R1=2.2K C1=270pF C2=0pF	R1=2.2K C1=120pF C2=0pF	R1=2.2K C1=100pF C2=0pF	R1=2.2K C1=68pF C2=0pF
52-56	1	1	R1=2.2K C1=220pF C2=0pF	R1=2.2K C1=100pF C2=0pF	R1=2.2K C1=82pF C2=0pF	R1=2.2K C1=56pF C2=0pF
56-60	1	1	R1=2.2K C1=220pF C2=0pF	R1=2.2K C1=100pF C2=0pF	R1=2.2K C1=68pF C2=0pF	R1=2.2K C1=39pF C2=0pF
60-64	1	1	R1=7.5K C1=120pF C2=33pF	R1=7.5K C1=68pF C2=0pF	R1=7.5K C1=47pF C2=0pF	R1=7.5K C1=33pF C2=0pF
64-68	1	1	R1=7.5K C1=120pF C2=33pF	R1=7.5K C1=68pF C2=0pF	R1=7.5K C1=47pF C2=0pF	R1=7.5K C1=27pF C2=0pF

Note: 0 pF means that the capacitor is removed.

Table 6.

NOTE: When clock frequency is on boundary between two ranges, it is recommended that the higher range be used.

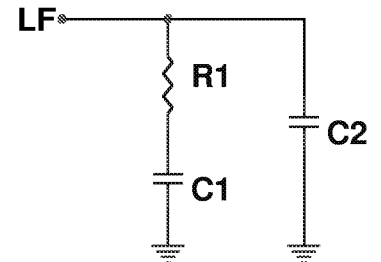

Recommended Loop Filter Values (VDD = 3.3 VDC, +/- 10%)						
Input (MHz)	RS1	RS0	BW = 1% (+/- .5%)	BW = 2% (+/- 1%)	BW = 3% (+/- 1.5%)	BW = 4% (+/- 2%)
4-8	0	0	R1=2.2K C1=220pF C2=22pF	R1=2.2K C1=100pF C2=22pF	R1=2.2K C1=68pF C2=22pF	R1=2.2K C1=39pF C2=22pF
8-12	0	1	R1=2.2K C1=470pF C2=22pF	R1=2.2K C1=220pF C2=22pF	R1=2.2K C1=150pF C2=22pF	R1=2.2K C1=100pF C2=22pF
12-16	0	1	R1=2.2K C1=120pF C2=22pF	R1=2.2K C1=56pF C2=22pF	R1=2.2K C1=39pF C2=22pF	R1=2.2K C1=27pF C2=8pF
16-20	1	0	R1=2.2K C1=680pF C2=22pF	R1=2.2K C1=390pF C2=22pF	R1=2.2K C1=270pF C2=22pF	R1=2.2K C1=180pF C2=22pF
20-24	1	0	R1=2.2K C1=560pF C2=22pF	R1=2.2K C1=220pF C2=22pF	R1=2.2K C1=120pF C2=22pF	R1=2.2K C1=82pF C2=22pF
24-28	1	0	R1=2.2K C1=220pF C2=22pF	R1=2.2K C1=82pF C2=22pF	R1=2.2K C1=56pF C2=22pF	R1=2.2K C1=39pF C2=10pF
28-32	1	0	R1=4.7K C1=180pF C2=0pF	R1=4.7K C1=68pF C2=0pF	R1=4.7K C1=39pF C2=0pF	R1=4.7K C1=27pF C2=0pF
32-36	1	0	R1=4.7K C1=82pF C2=0pF	R1=4.7K C1=33pF C2=0pF	R1=4.7K C1=22pF C2=0pF	R1=4.7K C1=12pF C2=0pF
36-40	1	1	R1=4.7K C1=1.0uF C2=390pF	R1=4.7K C1=1.0uF C2=220pF	R1=4.7K C1=1.0uF C2=150pF	R1=4.7K C1=1.0uF C2=100pF
40-44	1	1	R1=2.2K C1=680pF C2=0pF	R1=2.2K C1=270pF C2=0pF	R1=2.2K C1=180pF C2=10pF	R1=2.2K C1=120pF C2=10pF
44-48	1	1	R1=2.2K C1=330pF C2=0pF	R1=2.2K C1=180pF C2=0pF	R1=2.2K C1=120pF C2=0pF	R1=2.2K C1=82pF C2=0pF
48-52	1	1	R1=2.2K C1=270pF C2=0pF	R1=2.2K C1=120pF C2=0pF	R1=2.2K C1=82pF C2=0pF	R1=2.2K C1=56pF C2=0pF
52-56	1	1	R1=2.2K C1=220pF C2=0pF	R1=2.2K C1=100pF C2=0pF	R1=2.2K C1=68pF C2=0pF	R1=2.2K C1=33pF C2=0pF
56-60	1	1	R1=2.2K C1=150pF C2=0pF	R1=2.2K C1=68pF C2=5pF	R1=3.3K C1=47pF C2=12pF	R1=4.7K C1=33pF C2=22pF
60-64	1	1	R1=4.7K C1=100pF C1=0pF	R1=4.7K C1=47pF C2=0pF	R1=4.7K C1=27pF C2=0pF	R1=4.7K C1=18pF C1=0pF
64-68	1	1	R1=7.5K C1=68pF C2=0pF	R1=7.5K C1=33pF C2=0pF	R1=7.5K C1=22pF C2=0pF	R1=7.5K C1=15pF C2=0pF

Note: 0 pF. means that the capacitor is removed.

Table 7.

NOTE: When clock frequency is on boundary between two ranges, it is recommended that the higher range be used.

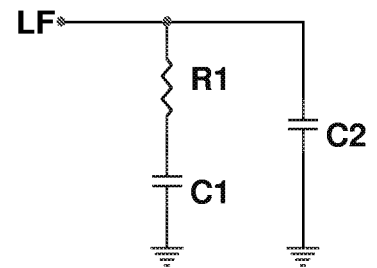

SSCG Modulation Profile

The modulation rate of the FS741 is determined by the input frequency and the operating range. The input frequency is divided by a fixed number, depending on the operating range that is selected. The modulation rate of the FS741 can be determined from the chart at the right.

Xin Range	Mod. rate divider
4 - 8 MHz	60
8 - 16 MHz	120
16 - 40 MHz	240
40 - 68 MHz	480

Example: Freq. of Xin = 25 MHz
 Operating Range = 16 - 40 MHz
 Modrate = $F_{xin}/240 = 104.166 \text{ KHz}$.

Table 8

With the correct loop filter connected to pin 4, the following profile will provide the best EMI reduction. This profile can be seen on a Time Domain Analyzer.

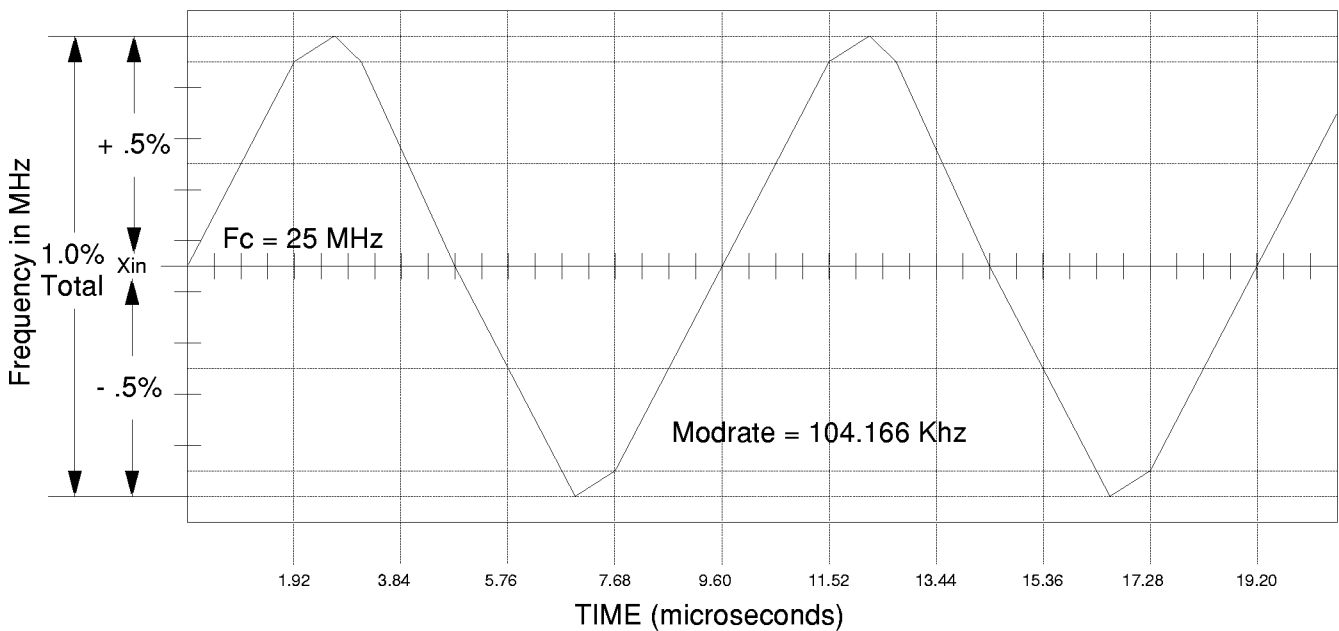

Figure 5. Frequency Profile in Time Domain

THEORY OF OPERATION

The FS741 is a Phase Lock Loop (PLL) type clock generator using Direct Digital Synthesis (DDS). By precisely controlling the bandwidth of the output clock, the FS741 becomes a Low EMI clock generator. The theory and detailed operation of the FS741 will be discussed in the following sections.

EMI

All clocks generate unwanted energy in their harmonics. Conventional digital clocks are square waves with a duty cycle that is very close to 50 %. Because of the 50/50 duty cycle, digital clocks generate most of their harmonic energy in the odd harmonics, i.e.; 3rd, 5th, 7th etc. It is possible to reduce the amount of energy contained in the fundamental and harmonics by increasing the bandwidth of the fundamental clock frequency. Conventional digital clocks have a very high Q factor, which means that all of the energy at that frequency is concentrated in a very narrow bandwidth, consequently, higher energy peaks. Regulatory agencies test electronic equipment by the amount of peak energy radiated from the equipment. By reducing the peak energy at the fundamental and harmonics, the equipment under test is able to satisfy agency requirements for Electro-Magnetic Interference (EMI). Conventional methods of reducing EMI have been to use shielding, filtering, multi-layer PCB's etc. The FS741 uses the approach of reducing the peak energy in the clock by increasing the clock bandwidth, and lowering the Q.

SSCG

The FS741 uses a proprietary technique to modulate the clock over a very narrow bandwidth and controlled rate of change, both peak and cycle to cycle. The FS741 takes a narrow band digital reference clock in the range 4 - 68 MHz and produces a clock that sweeps between a controlled start and stop frequency and precise rate of change. To understand what happens to an SSCG clock, consider that we have a 20 MHz clock with a 50 % duty cycle. From a 20 MHz clock we know the following;

Clock Frequency = $F_c = 20$ MHz.
Clock Period = $T_c = 1/20$ MHz = 50 ns

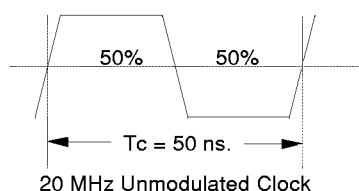

Figure 6.

Consider that this 20 MHz clock is applied to the Xin input of the FS741, either as an externally driven clock or as the result of a parallel resonant crystal connected to pins 1 and 2 of the FS741. Also consider that the FS741 is operating from a 5 volt DC power supply and the loop filter is set for a total bandwidth spread of 2%. Refer to table 6 on page 7.

From the above parameters, the output clock at Modout will be sweeping symmetrically around a center frequency of 20 MHz.

The minimum and maximum extremes of this clock will be +200 KHz and -200 KHz.. So, we have a clock that is sweeping from 19.8 MHz to 20.2 MHz and back again. If we were to look at this clock on a spectrum analyzer we would see the picture in Figure 7. Keep in mind that this is a drawing of a perfect clock with no noise.

We see that the original 20 MHz reference clock is at the center Frequency, F_c , and the minimum and maximum extremes are positioned symmetrically about the center frequency. This type of modulation is called **Center-Spread**. Figure 7 illustrates this as it is seen on a spectrum analyzer.

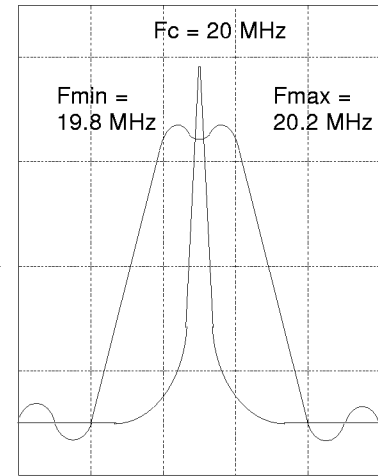

Figure 7.

Figure 8 shows a 20 MHz clock as it would be seen on an oscilloscope. The top trace is the non-modulated reference clock, or the Refout clock at pin 7. The bottom trace is the modulated clock at pin 6. From this comparison chart you can see that the frequency is decreasing and the period of each successive clock increasing. The T_c measurements on the left and right of the bottom trace indicate the max. and min. extremes of the clock. Intermediate clock changes are small and accumulate to achieve the total period deviation. The reverse of this Figure would show the clock going from min. extreme back to the high extreme.

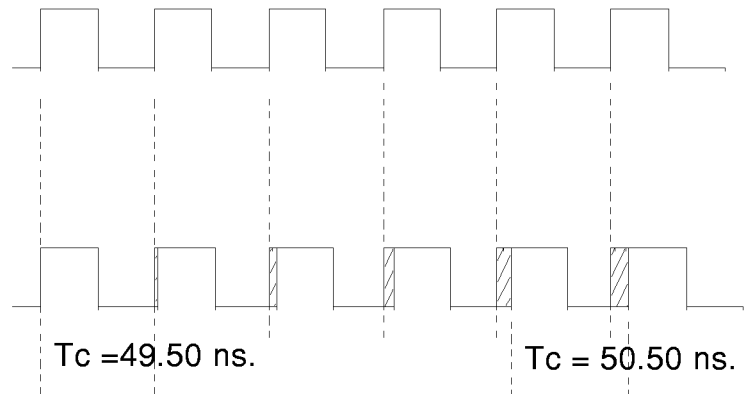

Figure 8. Period Comparison Chart

The FS741 is a center spread clock, meaning that it symmetrically spreads above and below the reference frequency. If a down spread clock is required for a specific application, refer to the datasheets for the SM530 and the SG52x series of Low EMI clock generators.

Looking at figure 7, you will note that the peak amplitude of the 20 MHz non-modulated clock is higher than the wideband modulated clock. This difference in peak amplitudes between modulated and unmodulated clocks is the reason why SSCG clocks are so effective in digital systems. This figure refers to the fundamental frequency of a clock. A very important characteristic of the SSCG clock is that the bandwidth of the harmonics is multiplied by the harmonic number. In other words, if the bandwidth of a 20 MHz clock is 200 KHz, the bandwidth of the 3rd harmonic will be 3 times 200 KHz, or 600 KHz. The amount of bandwidth is relative to the amount of energy in the clock. Consequently, the wider the bandwidth, the greater the energy reduction of the clock.

Most applications will not have a problem meeting agency specifications at the fundamental frequency. It is the higher harmonics that usually cause the most problems. With an SSCG clock, the bandwidth and peak energy reduction increases with the harmonic number. Consider that the 11th harmonic of a 20 MHz clock is 220 MHz. With a total spread of 200 KHz at 20 MHz, the spread at the 11th harmonic would be 2.20 MHz which greatly reduces the peak energy content.

The difference in the peak energy of the modulated clock and the non-modulated clock in typical applications will see a 2 - 3 db. reduction at the fundamental and as much as 8 - 10 db. reduction at the intermediate harmonics, 3rd, 5th, 7th etc. At the higher harmonics, it is quite possible to reduce the peak harmonic energy, compared to the unmodulated clock, by as much as 12 to 18 db.

The following images are actual scans of the FS741. These scans are from a spectrum analyzer and time domain analyzer of the FS741 running at 3.3 volts DC.

Figure 9 at the right shows a modulated 10 MHz clock at Modout of the FS741. The following parameters apply to this scan;

Fin = 10 Mhz.
 BW = 2% (total)
 Vertical scale = 6 dB/div.

From this scan it can be seen the bandwidth of the clock is wider than a conventional clock. Notice the EMI filters displayed at the bottom of the image. This is the same filter settings that are used by regulatory agencies.

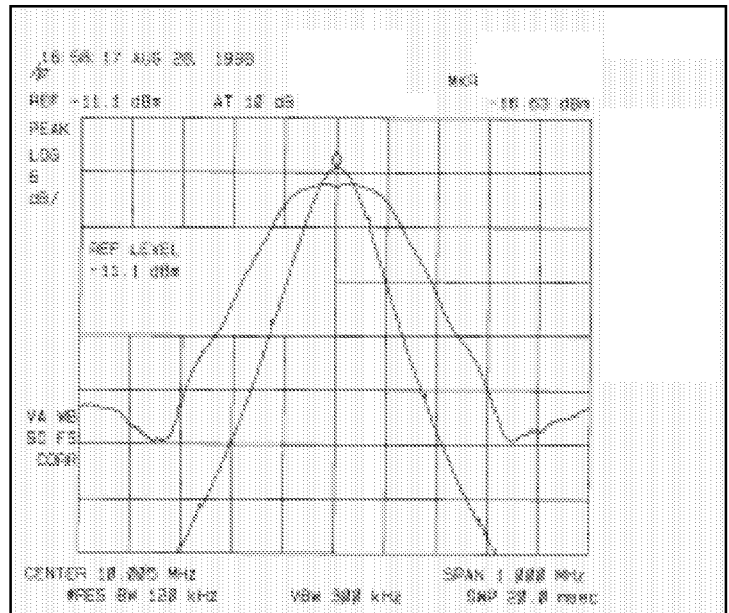

Figure 9.

It is clear from Figure 9, that the peak amplitude of the modulated clock is lower in amplitude than the non-modulated clock. In fact, this image indicates that the difference between the two peaks is approximately 2 dB.

Figure 10, at the right shows the 3rd. Harmonic of the 10 MHz clock in Figure 9. The big difference here is that the bandwidth of the 3rd. harmonic is 3 times greater than the bandwidth at the fundamental frequency. Since the energy is spread over a much wider bandwidth, the peak energy reduction will be greater. As can be seen in this picture, the difference between the modulated and un-modulated peaks is approximately 8 dB. With the bandwidth of the fundamental at 2% or 200 KHz, the bandwidth at the 3rd. harmonic will be 600 KHz.

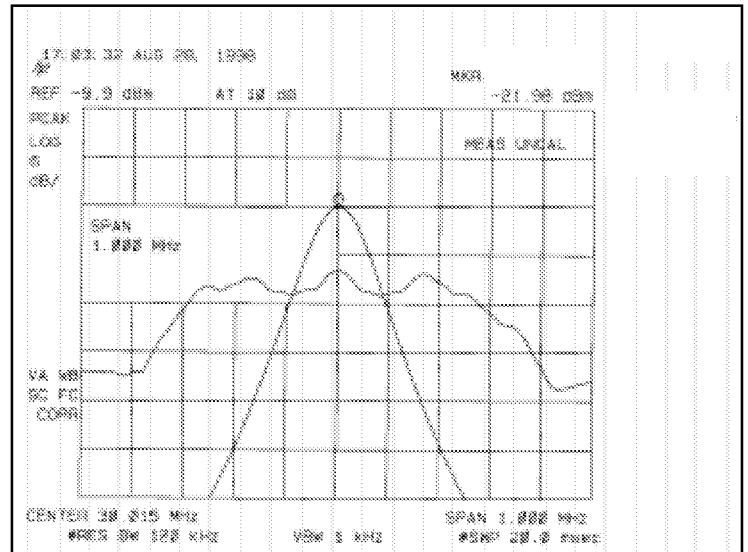

Figure 10.

Modulation Rate

The FS741 moves from max to min frequencies of its bandwidth at a pre-determined rate and profile. The modulation frequency is determined by the input frequency and the range that is selected. The FS741 has four input frequency operating ranges, 4 - 8 MHz, 8 - 16 MHz, 16 - 40 MHz and 40 - 68 MHz. The modulation rate is determined by a divider that results in 1/60, 1/120, 1/240 and 1/480 of the input frequency in each range, respectively. Refer to the chart on page 9.

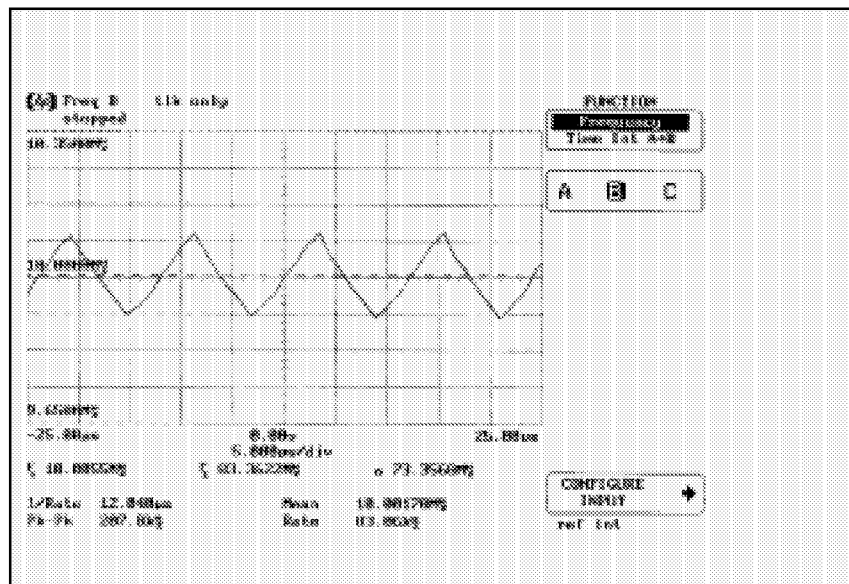

Figure 11. Frequency Modulation Profile

Approved Product

Low EMI Spectrum Spread Clock

The Xin reference clock determines the modulation frequency but the internal SSCG control logic determines the actual modulation profile. It is very important to note that the Bandwidth of the clock modulation is determined by the values of the loop filter applied to pin 4.

Figure 11 shows the modulation profile of the FS741. This type of test is done with a time domain analyzer. What this shows is the amount of time that the clock spends at any one frequency within its modulation envelope. From this type of picture, the amount of modulation percentage and modulation rate can be determined. This picture shows that the FS741 is modulating 2% around the 10 MHz input and the modulation rate is 83.06 KHz.

APPLICATION NOTES AND SCHEMATICS

The schematic diagram shown below is a simple minimum component application example of an FS741 design.

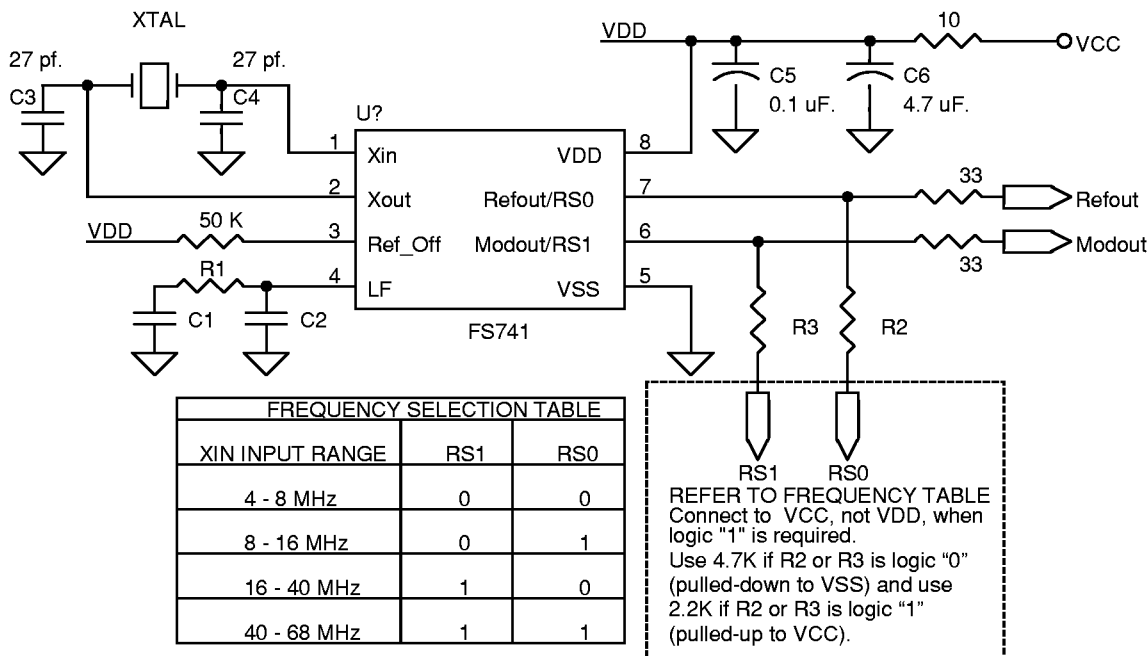

Note: C3 and C4 values assume a first order crystal with $C_L = 17$ pF.

Figure 12.

Figure 13 is the equivalent internal oscillator circuit used in the FS741;

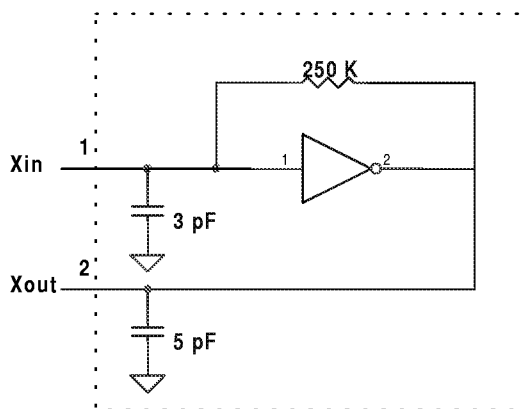

Figure 13.

Calculating dB Reduction

The dB reduction for a give frequency and spread can be calculated using a simple formula. This formula is only helpful in determining a relative dB reduction for a given application. This formula assumes an ideal clock with 50% duty cycle and therefore only predicts the EMI reduction of odd harmonics. Other circumstances such as non-ideal clock and noise will affect the actual dB reduction. The formula is as follows:

$$\text{dB} = 6.5 + 9(\text{Log}_{10}(\text{F})) + 9(\text{Log}_{10}(\text{P}))$$

Where; F = Frequency in Mhz, P = total % spread (2.5% = .025)

Using a 50 Mhz clock with a 2.5% spread, the theoretical dB reduction would be;

$$\begin{aligned} \text{db @ 50 Mhz (Fund)} &= 6.5 + 15.29 - 14.42 = 7.37 \\ \text{dB @ 150 Mhz (3rd)} &= 6.5 + 19.58 - 14.42 = 11.66 \\ \text{dB @ 550 Mhz (11th)} &= 6.5 + 24.66 - 14.42 = 16.74 \end{aligned}$$

PACKAGE DIMENSIONS AND DRAWINGS

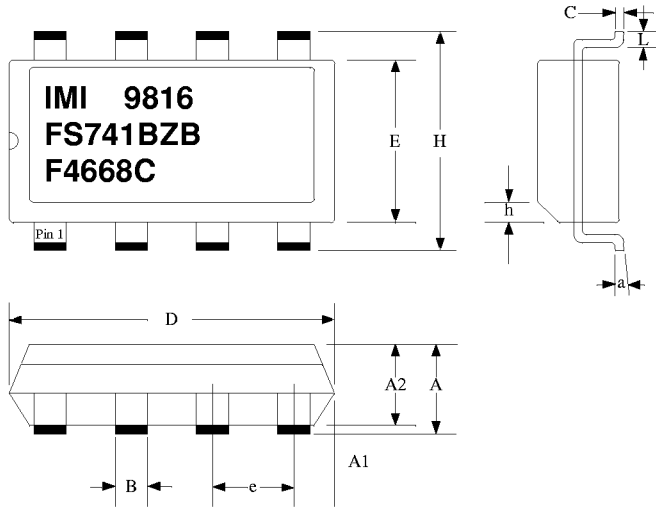

8 PIN SOIC OUTLINE DIMENSIONS						
SYMBOL	INCHES			MILLIMETERS		
	MIN	NOM	MAX	MIN	NOM	MAX
A	0.061	0.064	0.068	1.55	1.63	1.73
A ₁	0.004	0.006	0.0098	0.127	0.150	0.250
A ₂	0.055	0.058	0.061	1.40	1.47	1.55
B	0.0138	0.016	0.0192	0.35	0.41	0.49
C	0.0075	0.008	0.0098	0.19	0.20	0.25
D	0.189	0.194	0.196	4.80	4.93	4.98
E	0.150	0.155	0.157	3.81	3.94	3.99
e	0.050 BSC			1.270 BSC		
H	.230	.236	.244	5.84	5.99	6.20
h	0.010	0.013	0.016	0.25	0.33	0.41
a	0°	5°	8°	0°	5°	8°
L	0.016	0.025	0.035	0.41	0.64	0.89

8 PIN SOIC PACKAGE

NOTES:

Disclaimer

International Microcircuits, Inc. reserves the right to change or modify the information contained in this data sheet, without notice. International Microcircuits, Inc., does not assume any liability arising out of the application or use of any product or circuit described herein. International Microcircuits, Inc., does not convey any license under its patent rights nor the rights of others. International Microcircuits, Inc. does not authorize its products for use as critical components in life-support systems or critical medical instruments, where a malfunction or failure may reasonably be expected to result in significant injury to the user.