



IR Emitter and Detector Product Data Sheet

LTE-7477LM1-TA

Spec No.: DS50-2001-010

Effective Date: 10/19/2001

Revision: -

LITE-ON DCC

RELEASE

BNS-OD-FC001/A4

FEATURES

- * HIGH SPEED
- * HIGH POWER
- * AVAILABLE FOR PULSE OPERATING
- * BLUE TRANSPARENT COLOR PACKAGE

PACKAGE DIMENSIONS

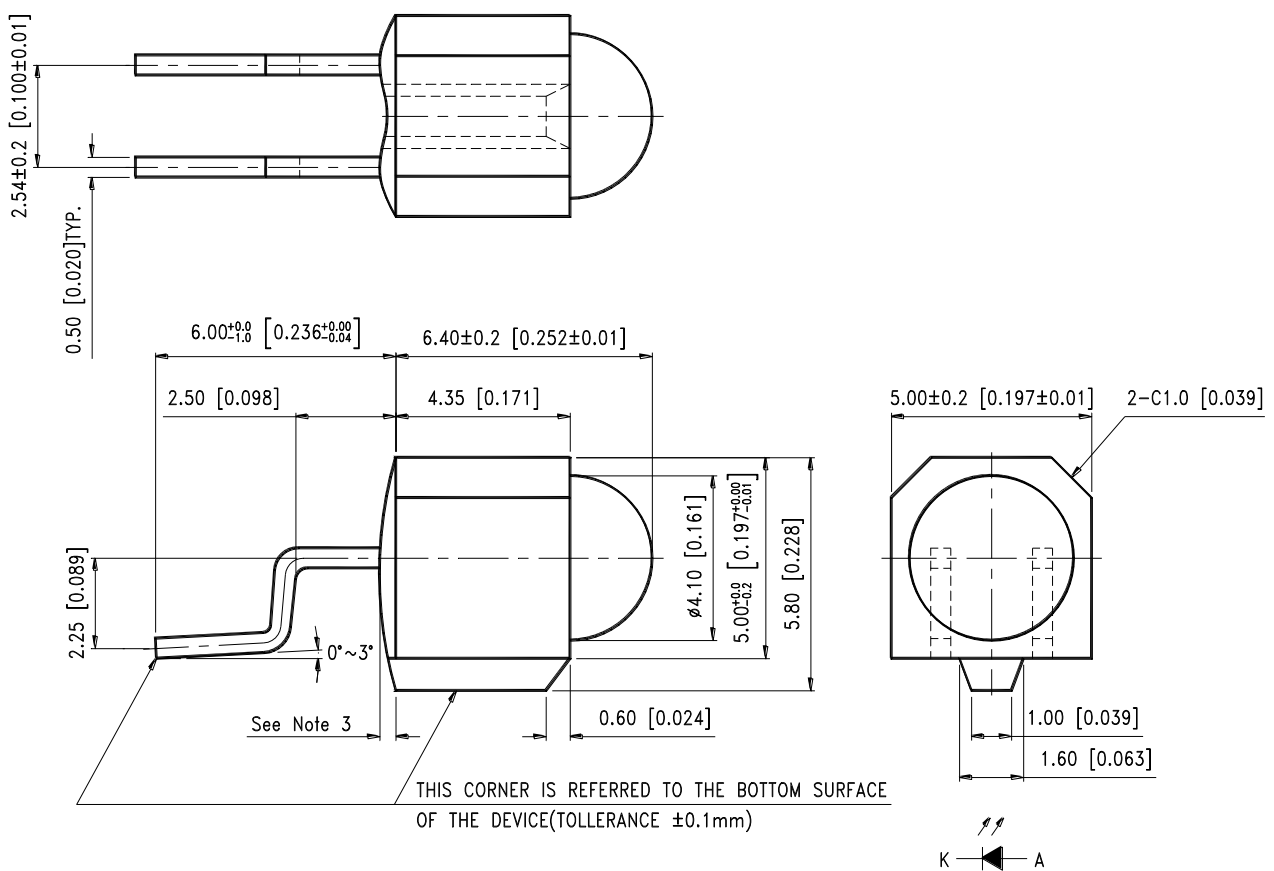

NOTES:

1. All dimensions are in millimeters (inches).
2. Tolerance is ± 0.25 mm (.010") unless otherwise noted.
3. Protruded resin under flange is 1.5mm (.059") max.
4. Lead spacing is measured where the leads emerge from the package.
5. Specifications are subject to change without notice.



ABSOLUTE MAXIMUM RATINGS AT TA=25°C

| PARAMETER | MAXIMUM RATING | UNIT |
|--|---------------------|------|
| Power Dissipation | 200 | mW |
| Peak Forward Current (100pps, 10 μs pulse) | 2 | A |
| Continuous Forward Current | 100 | mA |
| Reverse Voltage | 5 | V |
| Operating Temperature Range | -40°C to + 85°C | |
| Storage Temperature Range | -55°C to + 100°C | |
| Lead Soldering Temperature [1.6mm(.063") From Body] | 260°C for 5 Seconds | |

ELECTRICAL / OPTICAL CHARACTERISTICS AT TA=25°C

| PARAMETER | SYMBOL | MIN. | TYP. | MAX. | UNIT | TEST CONDITION |
|---------------------------|--------------------------------|------|------|------|-------|---|
| Radiant Intensity | I _E | 35 | | 75 | mW/sr | I _F = 50mA |
| Peak Emission Wavelength | λ _P | | 880 | | nm | I _F = 50mA |
| Spectral Line Half-Width | Δλ | | 50 | | nm | I _F = 50mA |
| Forward Voltage | V _F | 1.5 | 1.75 | 2.1 | V | I _F = 350mA 100pps 10 μs pulse |
| Reverse Current | I _R | | | 100 | μA | V _R = 5V |
| Rise/Fall Time | T _r /T _f | | 40 | | nS | 10% ~ 90% |
| Viewing Angle (See FIG.6) | 2θ _{1/2} | | 16 | | deg. | I _F = 20mA |

TYPICAL ELECTRICAL / OPTICAL CHARACTERISTICS CURVES

(25°C Ambient Temperature Unless Otherwise Noted)

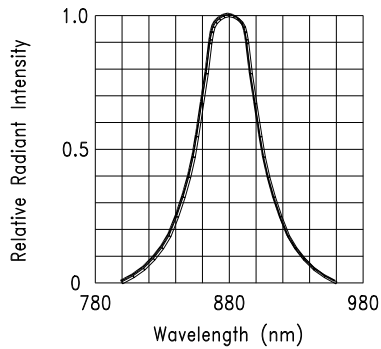

FIG.1 SPECTRAL DISTRIBUTION

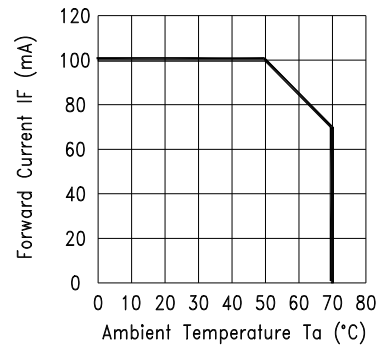

FIG.2 FORWARD CURRENT VS. AMBIENT TEMPERATURE

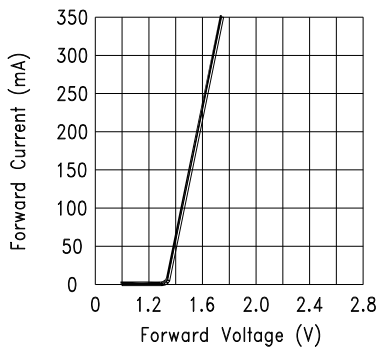

FIG.3 FORWARD CURRENT VS. FORWARD VOLTAGE

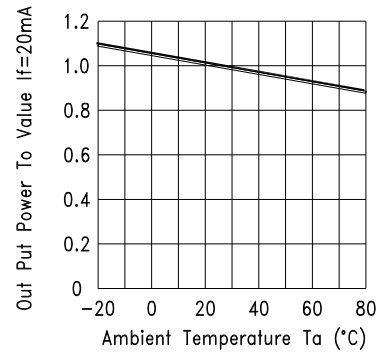

FIG.4 RELATIVE RADIANT INTENSITY VS. AMBIENT TEMPERATURE

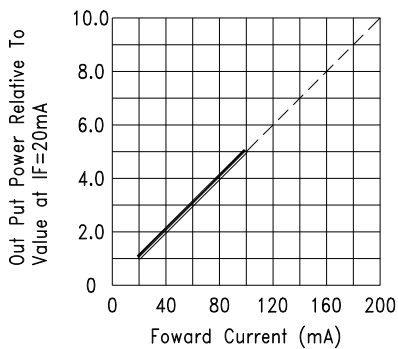

FIG.5 RELATIVE RADIANT INTENSITY VS. FORWARD CURRENT

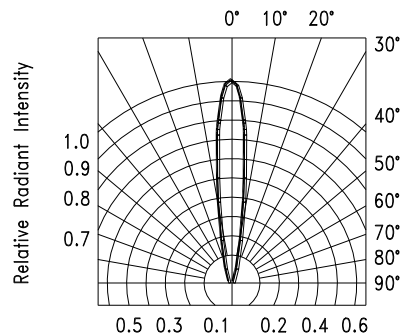
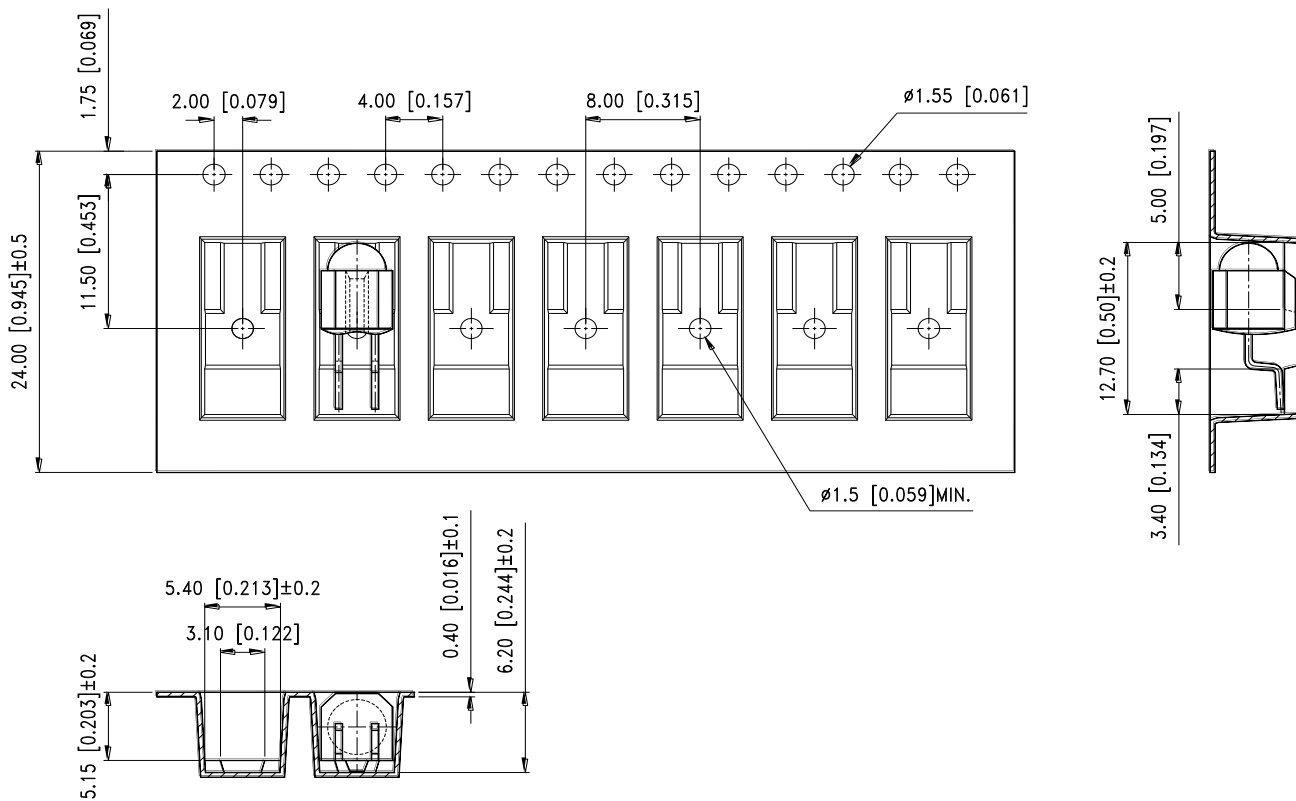

FIG.6 RADIATION DIAGRAM

Packing



Package Dimensions of Reel

