

## Super Junction MOSFET

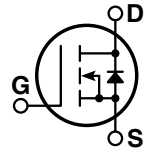

- Ultra low  $R_{DS(ON)}$
- Low Miller Capacitance
- Ultra Low Gate Charge,  $Q_g$
- Avalanche Energy Rated
- TO-247 or Surface Mount D<sup>3</sup>PAK Package

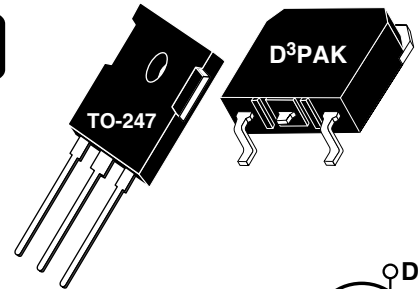

### MAXIMUM RATINGS

All Ratings:  $T_C = 25^\circ\text{C}$  unless otherwise specified.

Symbol	Parameter	APT17N80BC3_SC3	UNIT
$V_{DSS}$	Drain-Source Voltage	800	Volts
$I_D$	Continuous Drain Current @ $T_C = 25^\circ\text{C}$	17	Amps
$I_{DM}$	Pulsed Drain Current <sup>①</sup>	51	
$V_{GS}$	Gate-Source Voltage Continuous	$\pm 20$	Volts
$V_{GSM}$	Gate-Source Voltage Transient	$\pm 30$	
$P_D$	Total Power Dissipation @ $T_C = 25^\circ\text{C}$	208	Watts
	Linear Derating Factor	1.67	W/ $^\circ\text{C}$
$T_J, T_{STG}$	Operating and Storage Junction Temperature Range	-55 to 150	$^\circ\text{C}$
$T_L$	Lead Temperature: 0.063" from Case for 10 Sec.	300	
$dv/dt$	Drain-Source Voltage slope ( $V_{DS} = 640\text{V}$ , $I_D = 17\text{A}$ , $T_J = 125^\circ\text{C}$ )	50	V/ns
$I_{AR}$	Repetitive Avalanche Current <sup>⑦</sup>	17	Amps
$E_{AR}$	Repetitive Avalanche Energy <sup>⑦</sup>	0.5	mJ
$E_{AS}$	Single Pulse Avalanche Energy <sup>④</sup>	670	

### STATIC ELECTRICAL CHARACTERISTICS

Symbol	Characteristic / Test Conditions	MIN	TYP	MAX	UNIT
$BV_{DSS}$	Drain-Source Breakdown Voltage ( $V_{GS} = 0\text{V}$ , $I_D = 250\mu\text{A}$ )	800			Volts
$R_{DS(on)}$	Drain-Source On-State Resistance <sup>②</sup> ( $V_{GS} = 10\text{V}$ , 11A)		0.25	0.29	Ohms
$I_{DSS}$	Zero Gate Voltage Drain Current ( $V_{DS} = 800\text{V}$ , $V_{GS} = 0\text{V}$ )		0.5	25	$\mu\text{A}$
	Zero Gate Voltage Drain Current ( $V_{DS} = 800\text{V}$ , $V_{GS} = 0\text{V}$ , $T_C = 150^\circ\text{C}$ )			250	
$I_{GSS}$	Gate-Source Leakage Current ( $V_{GS} = \pm 20\text{V}$ , $V_{DS} = 0\text{V}$ )			$\pm 100$	nA
$V_{GS(th)}$	Gate Threshold Voltage ( $V_{DS} = V_{GS}$ , $I_D = 1\text{mA}$ )	2.10	3	3.9	Volts

 **CAUTION:** These Devices are Sensitive to Electrostatic Discharge. Proper Handling Procedures Should Be Followed.

APT Website - <http://www.advancedpower.com>

"COOLMOS™" comprise a new family of transistors developed by Infineon Technologies AG. "COOLMOS" is a trademark of Infineon Technologies AG"

**DYNAMIC CHARACTERISTICS**

**APT17N80BC3\_SC3**

Symbol	Characteristic	Test Conditions	MIN	TYP	MAX	UNIT
C <sub>iss</sub>	Input Capacitance	V <sub>GS</sub> = 0V V <sub>DS</sub> = 25V f = 1 MHz		2255		pF
C <sub>oss</sub>	Output Capacitance			1045		
C <sub>rss</sub>	Reverse Transfer Capacitance			55		
Q <sub>g</sub>	Total Gate Charge ③	V <sub>GS</sub> = 0 to 10V V <sub>DD</sub> = 400V I <sub>D</sub> = 17A @ 25°C		90		nC
Q <sub>gs</sub>	Gate-Source Charge			11		
Q <sub>gd</sub>	Gate-Drain ("Miller") Charge			45		
t <sub>d(on)</sub>	Turn-on Delay Time	<b>RESISTIVE SWITCHING</b> V <sub>GS</sub> = 10V V <sub>DD</sub> = 400V I <sub>D</sub> = 17A @ 125°C R <sub>G</sub> = 4.7Ω		25		ns
t <sub>r</sub>	Rise Time			15		
t <sub>d(off)</sub>	Turn-off Delay Time			70	82	
t <sub>f</sub>	Fall Time			6	9	
E <sub>on</sub>	Turn-on Switching Energy ⑥	<b>INDUCTIVE SWITCHING @ 25°C</b> V <sub>DD</sub> = 533V, V <sub>GS</sub> = 15V I <sub>D</sub> = 17A, R <sub>G</sub> = 5Ω		245		μJ
E <sub>off</sub>	Turn-off Switching Energy			140		
E <sub>on</sub>	Turn-on Switching Energy ⑥	<b>INDUCTIVE SWITCHING @ 125°C</b> V <sub>DD</sub> = 533V, V <sub>GS</sub> = 15V I <sub>D</sub> = 17A, R <sub>G</sub> = 5Ω		425		
E <sub>off</sub>	Turn-off Switching Energy			170		

**SOURCE-DRAIN DIODE RATINGS AND CHARACTERISTICS**

Symbol	Characteristic / Test Conditions	MIN	TYP	MAX	UNIT
I <sub>S</sub>	Continuous Source Current (Body Diode)			17	Amps
I <sub>SM</sub>	Pulsed Source Current ① (Body Diode)			51	
V <sub>SD</sub>	Diode Forward Voltage ② (V <sub>GS</sub> = 0V, I <sub>S</sub> = -17A)		1	1.2	Volts
t <sub>rr</sub>	Reverse Recovery Time (I <sub>S</sub> = -17A, di <sub>S</sub> /dt = 100A/μs, V <sub>R</sub> = 400V)		550		ns
Q <sub>rr</sub>	Reverse Recovery Charge (I <sub>S</sub> = -17A, di <sub>S</sub> /dt = 100A/μs, V <sub>R</sub> = 400V)		15		μC
dv/dt	Peak Diode Recovery dv/dt ⑤			6	V/ns

**THERMAL CHARACTERISTICS**

Symbol	Characteristic	MIN	TYP	MAX	UNIT
R <sub>θJC</sub>	Junction to Case			0.60	°C/W
R <sub>θJA</sub>	Junction to Ambient			40	

- ① Repetitive Rating: Pulse width limited by maximum junction temperature
- ② Pulse Test: Pulse width < 380 μs, Duty Cycle < 2%
- ③ See MIL-STD-750 Method 3471

- ④ Starting T<sub>J</sub> = +25°C, L = 115.92mH, R<sub>G</sub> = 25Ω, Peak I<sub>L</sub> = 3.4A
- ⑤ I<sub>S</sub> = -17A di<sub>S</sub>/dt = 100A/μs V<sub>R</sub> = 480V T<sub>J</sub> = 125°C
- ⑥ E<sub>on</sub> includes diode reverse recovery. See figures 18, 20.
- ⑦ Repetitive avalanche causes additional power losses that can be calculated as P<sub>AV</sub> = E<sub>AR</sub> \* f

APT Reserves the right to change, without notice, the specifications and information contained herein.

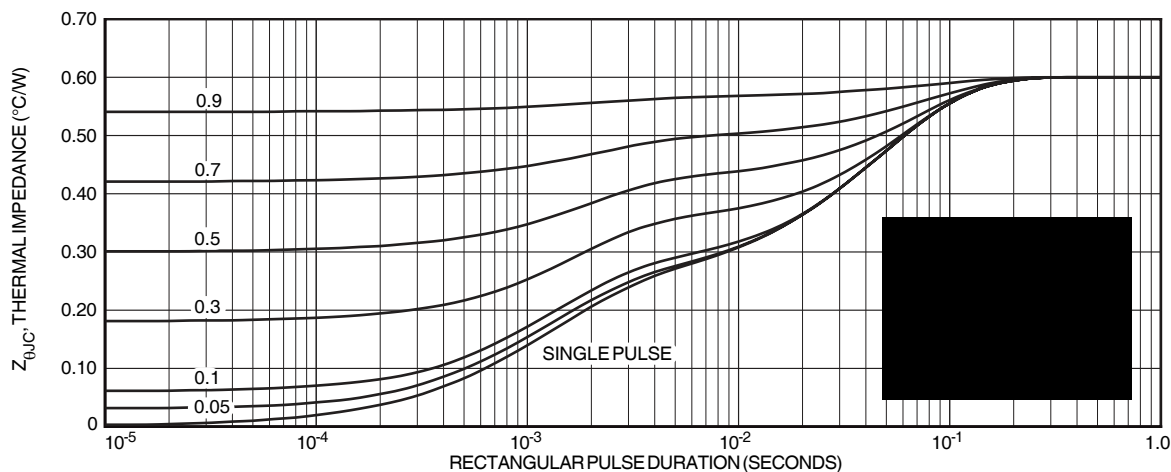

**FIGURE 1, MAXIMUM EFFECTIVE TRANSIENT THERMAL IMPEDANCE, JUNCTION-TO-CASE vs PULSE DURATION**

# Typical Performance Curves

APT17N80BC3\_SC3

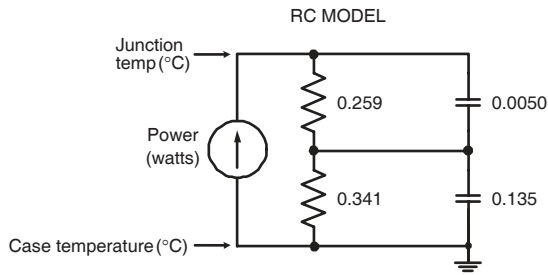

FIGURE 2, TRANSIENT THERMAL IMPEDANCE MODEL

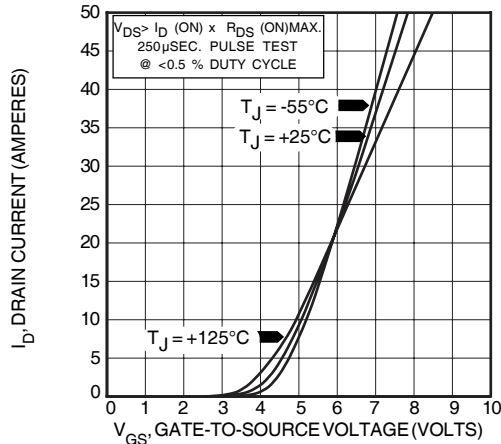

FIGURE 4, TRANSFER CHARACTERISTICS

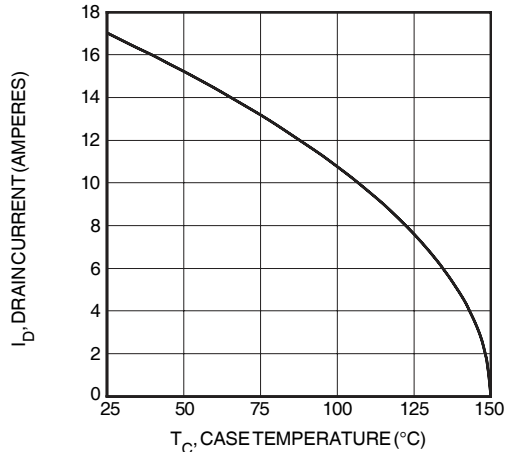

FIGURE 6, MAXIMUM DRAIN CURRENT vs CASE TEMPERATURE

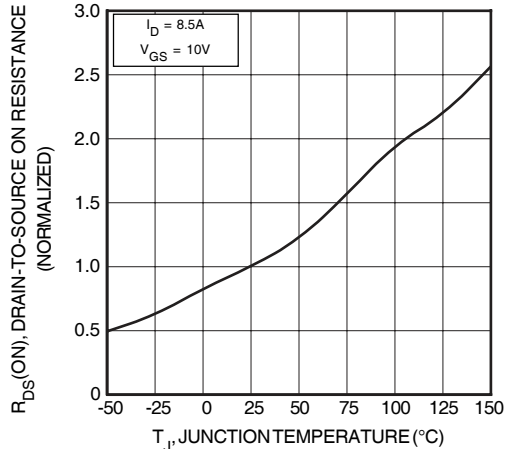

FIGURE 8, ON-RESISTANCE vs. TEMPERATURE

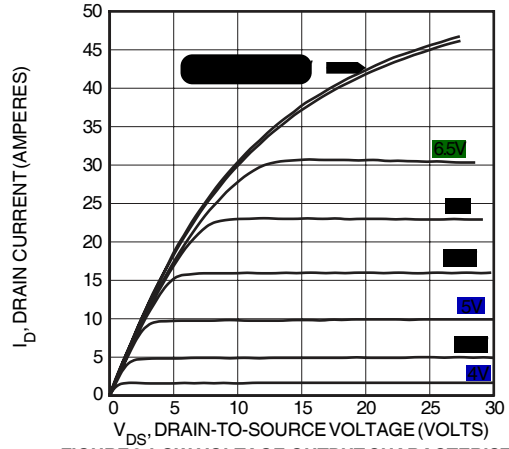

FIGURE 3, LOW VOLTAGE OUTPUT CHARACTERISTICS

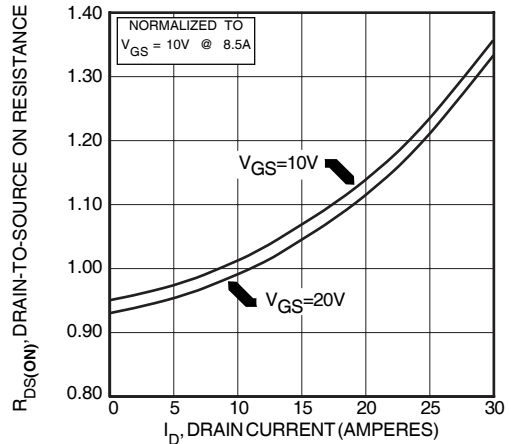

FIGURE 5,  $R_{DS(ON)}$  vs DRAIN CURRENT

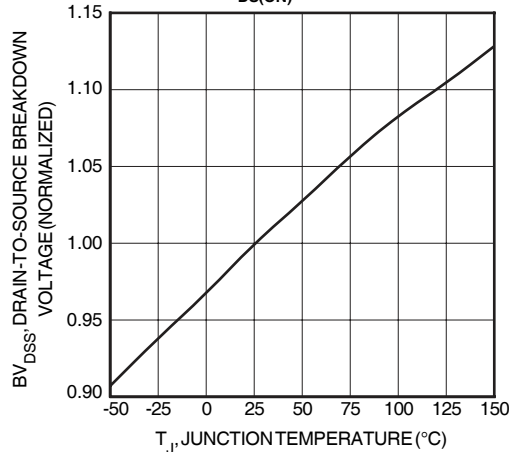

FIGURE 7, BREAKDOWN VOLTAGE vs TEMPERATURE

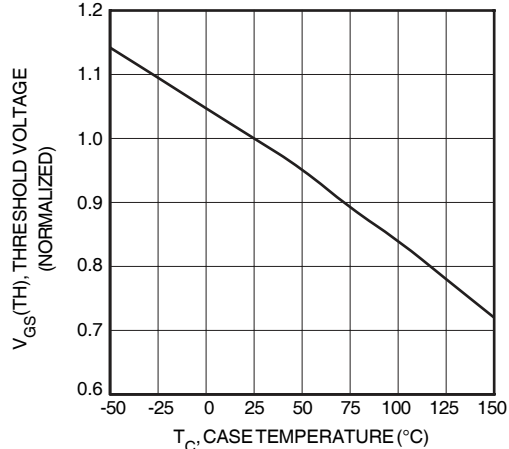

FIGURE 9, THRESHOLD VOLTAGE vs TEMPERATURE

Typical Performance Curves

APT17N80BC3\_SC3

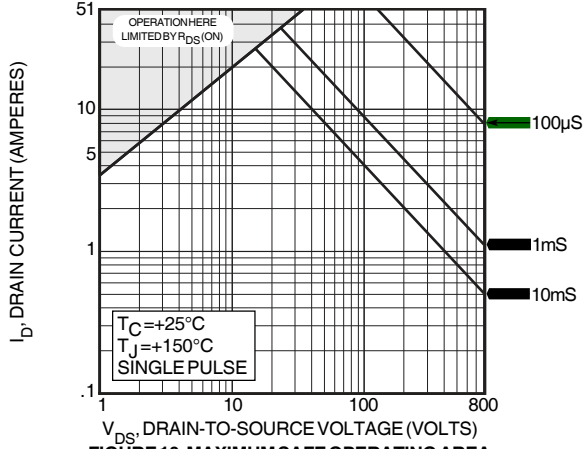

FIGURE 10, MAXIMUM SAFE OPERATING AREA

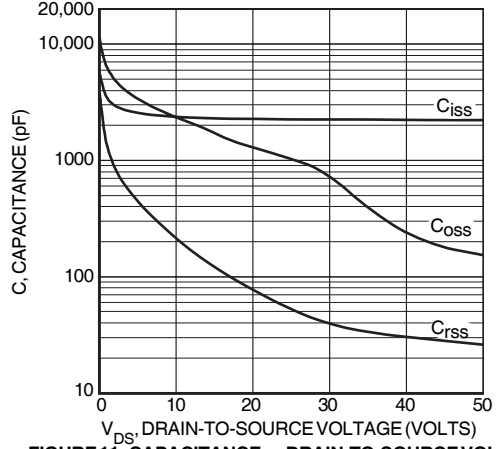

FIGURE 11, CAPACITANCE vs DRAIN-TO-SOURCE VOLTAGE

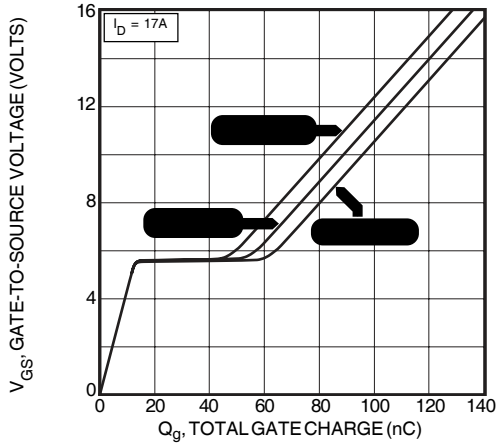

FIGURE 12, GATE CHARGES vs GATE-TO-SOURCE VOLTAGE

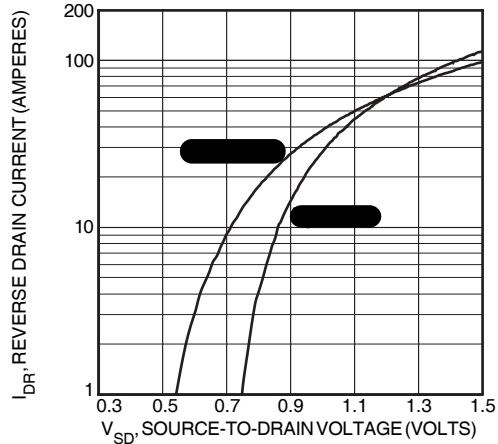

FIGURE 13, SOURCE-DRAIN DIODE FORWARD VOLTAGE

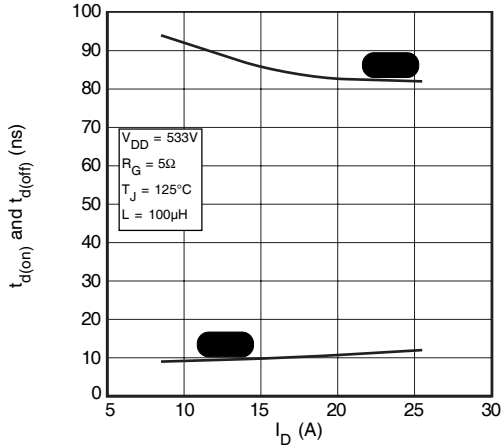

FIGURE 14, DELAY TIMES vs CURRENT

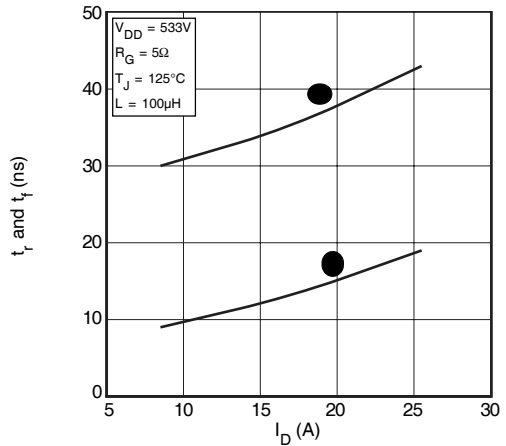

FIGURE 15, RISE AND FALL TIMES vs CURRENT

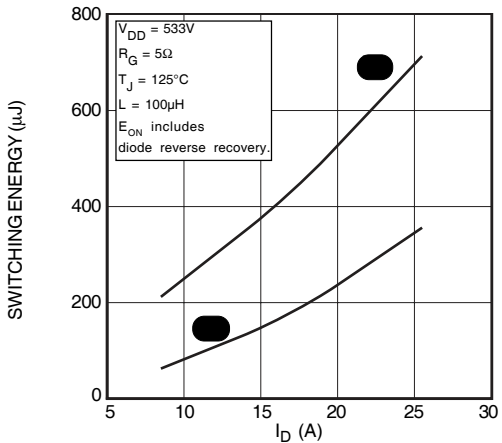

FIGURE 16, SWITCHING ENERGY vs CURRENT

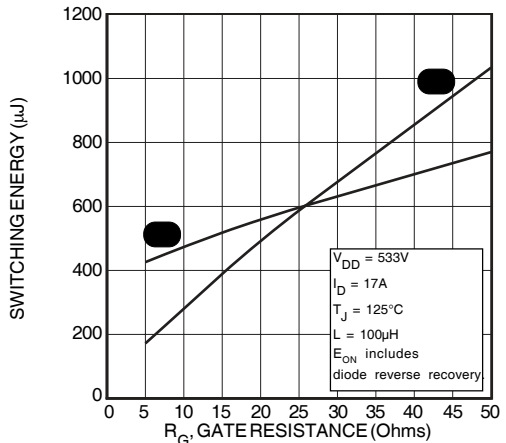

FIGURE 17, SWITCHING ENERGY vs. GATE RESISTANCE

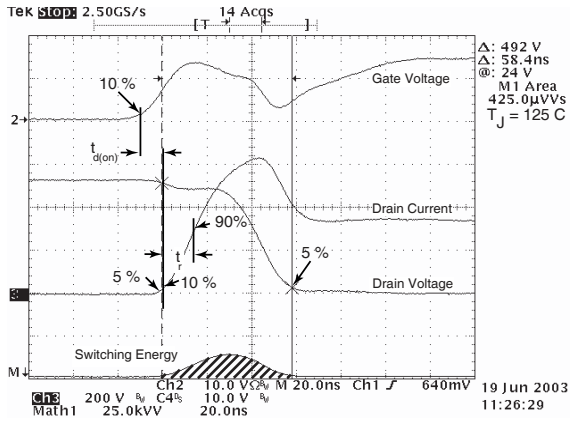

Figure 18, Turn-on Switching Waveforms and Definitions

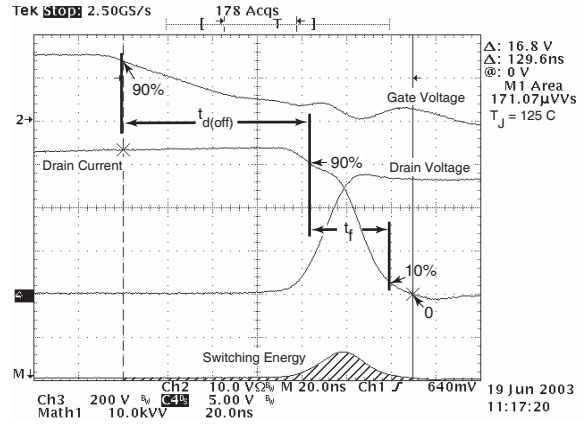

Figure 19, Turn-off Switching Waveforms and Definitions

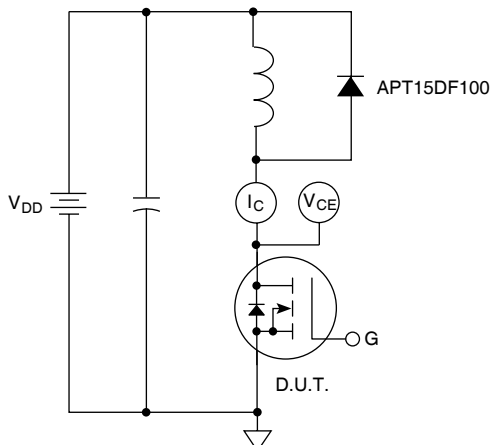
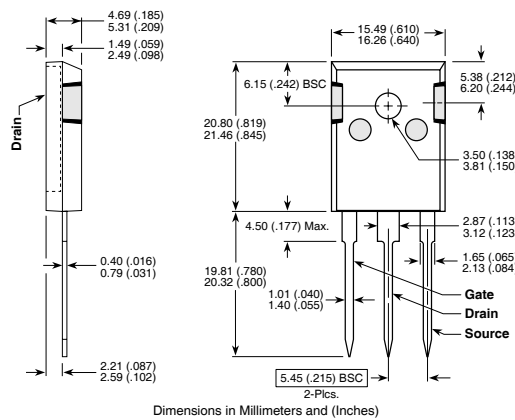
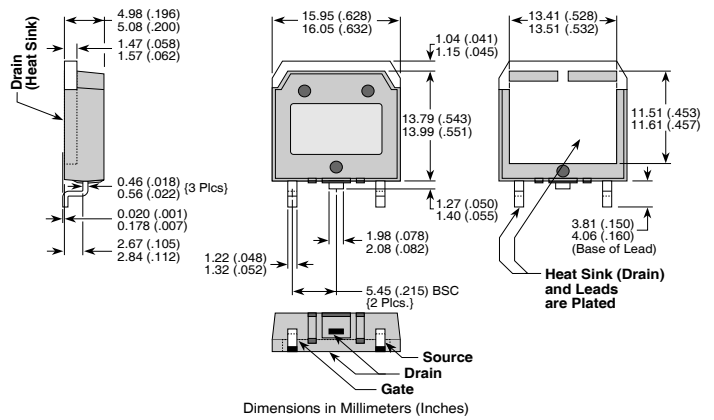

Figure 20, Inductive Switching Test Circuit

TO-247 Package Outline



D<sup>3</sup>PAK Package Outline



APT's products are covered by one or more of U.S. patents 4,895,810 5,045,903 5,089,434 5,182,234 5,019,522 5,262,336 6,503,786 5,256,583 4,748,103 5,283,202 5,231,474 5,434,095 5,528,058 and foreign patents. US and Foreign patents pending. All Rights Reserved.