

MAXIM

MAX3761 Evaluation Kit

Evaluates: MAX3761

General Description

The MAX3761 evaluation kit (EV kit) simplifies evaluation of the MAX3761 limiting amplifier. It allows easy programming of the loss-of-signal (LOS) threshold. The board layout provides for multiple termination configurations. The circuit includes space for the MAX3760 preamplifier and user-supplied photodiode. Adding these two components to the MAX3761 forms a complete fiber optic receiver.

Features

- ◆ Fully Assembled and Tested
- ◆ Easy LOS Threshold Programming
- ◆ Multiple Output Terminations
- ◆ Circuit Includes MAX3760 Preamplifier*
- ◆ Socket for User-Supplied Photodiode Signal Source

Component Suppliers

SUPPLIER	PHONE	FAX
AVX	(803) 946-0690	(803) 626-3123
Central Semiconductor	(603) 224-1961	(603) 224-1430
Coilcraft	(847) 639-6400	(847) 639-1469
Sprague	(516) 435-1110	(516) 435-1824
Zetex USA	(516) 543-7100	(516) 864-7630

Ordering Information

PART	TEMP. RANGE	BOARD TYPE
MAX3761EVKIT-SO	-40°C to +85°C	Surface Mount

Component List

DESIGNATION	QTY	DESCRIPTION
C1	1	33 μ F, 35V, \pm 10% tantalum cap Sprague 595D336X9035R2
C2	1	3.3 μ F, 25V, \pm 10% tantalum cap Sprague 595D335X9025B2
C3, C5, C7, C9, C30	5	0.027 μ F, 25V ceramic capacitors
C4, C6, C8, C10, C11	5	100pF, 25V ceramic capacitors
C12, C13, C14, C15	0	Open
C16, C17	2	5600pF, 25V ceramic capacitors
C26, R24, R28	3	0.1 μ F, 25V ceramic capacitors
C29	1	390pF, 25V ceramic capacitor
CAZ1	1	150pF, 16V ceramic capacitor
R2, R3, R15, R16, R19, R20, R23, R27	8	0 Ω resistors
R4	1	100k Ω potentiometer
R5, R40	2	2k Ω , 5% resistors
R6	1	100k Ω , 5% resistor
R7	1	5.1k Ω , 5% resistor
R8, R10, R11, R14, R17, R18, R21, R22, R26	0	Open
R9, R13, R41, R42, R44	5	1k Ω , 5% resistors
R12	1	100 Ω , 5% resistor
R25, R29	2	330 Ω , 5% resistors
R37	1	49.9 Ω , 1% resistor
R38, R39	2	820 Ω , 5% resistors

DESIGNATION	QTY	DESCRIPTION
R43	1	10k Ω potentiometer
D3	0	User-supplied photodiode
D4	1	High-speed switching diode Central Semiconductor CMPD4448BK
L1, L2, L3	3	5.6 μ H inductors Coilcraft 1008LS-562
L4	1	4.7 μ H inductor Coilcraft 1008CS-472
L5, L6	0	Open
L7	1	15 μ H inductor Coilcraft 1812CS-15XKBC
U1	1	MAX3761EEP
U2	1*	MAX3760ESA
Q3, Q4	2	PNP small-signal transistors Zetex BCX71KCT
PREAMP, OUT+, OUT-, LOS+, LOS-	5	SMA connectors (edge mount) E. F. Johnson 142-0701-801
VIN+, VIN-	2	SMA connectors (PC mount)
JU4, JU6, JU7, INV	4	2-pin headers
JU3, JU5	2	3-pin headers
VTH, RSSI	2	1-pin headers
None	3	Shunts for JU3, JU5, JU6
None	1	MAX3761/MAX3762 circuit board
None	1	MAX3761 data sheet

*Contact factory for availability.

Maxim Integrated Products 1

For free samples & the latest literature: <http://www.maxim-ic.com>, or phone 1-800-998-8800

MAX3761 Evaluation Kit

Quick Start

- 1) Connect a +5V power supply to the +5V pad, then connect the power-supply ground to the GND pad.
- 2) Ensure that the JU3 shunt is across pins 1 and 2.
- 3) Ensure that JU5 and JU4 are open.
- 4) Ensure that JU7 is shorted.
- 5) Apply a 100mV signal at VIN+ and VIN-, with a 622Mbps data rate.
- 6) Connect OUT+ and OUT- to a 50Ω terminated oscilloscope.

Detailed Description

Data Inputs

Differential Drive from a Signal Generator

The MAX3761 EV kit is factory configured with a 100Ω differential load AC coupled to the MAX3761 inputs.

Single-Ended Drive from a Signal Generator

Remove R12, install R10 and R11 = 49.9Ω, and connect the signal generator to VIN+. This provides a 50Ω termination to ground for the signal generator.

Differential Input from the Preamp

The MAX3761 EV kit incorporates the MAX3760 transimpedance amplifier. If the MAX3760 preamplifier is used, connect the +5V supply to the terminal labeled 5V OFFSET. Install shorts in L5 and L6 to connect the preamplifier to the limiting amplifier. Verify that R12 = 100Ω. Connect a signal generator to the preamplifier, or use a photodiode and light source connected at D3.

If a photodiode is used, remove R41. Figure 1 shows the proper installation of a user-supplied photodiode.

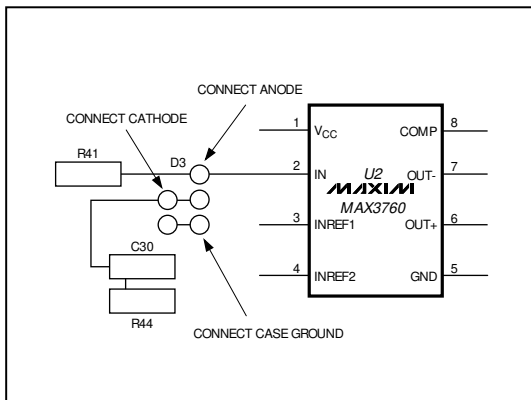

Figure 1. Photodiode Connection

Data Output Terminations

Oscilloscope Connection

The MAX3761 EV kit is shipped configured to connect to a 50Ω terminated oscilloscope. Each output is AC coupled and has a 330Ω resistor to ground, which provides bias current.

PECL Outputs

To drive a circuit that requires a PECL input, remove the 330Ω resistors (R25 and R29) and short the coupling capacitors (R24 and R28), then terminate with 50Ω to $V_{CC} - 2V$.

LOS Outputs

The MAX3761's LOS outputs are TTL compatible, with internal pull-up resistors. Connect the test point LOS+ to a voltmeter or high-impedance probe.

Adjustments and Controls

LOS Voltage Threshold Adjustment

Potentiometer R4 adjusts the V_{TH} voltage, which programs the LOS threshold. Refer to the MAX3761 data sheet for details.

Preamplifier Offset Current

Potentiometer R43 adjusts the amount of offset current at the preamplifier input (for use with the MAX3760 transimpedance amplifier). Refer to the MAX3760 data sheet for details.

Jumper JU7

JU7 implements the squelch function. When JU7 is shorted, the LOS+ terminal is connected to the DISABLE pin. When LOS+ is asserted high, the data outputs are disabled. If shorting JU7, remove JU5.

Jumper JU3

For normal operation, short pins 1 and 2.

Jumper JU5

JU5 sets the voltage at the disable pin. To hold the MAX3761's outputs enabled, short pins 2 and 3. To hold the MAX3761's outputs disabled, short pins 1 and 2. Remove JU5 if JU7 is used.

Jumper JU6

JU6 connects a current mirror to the MAX3760 transimpedance amplifier input, allowing DC offset current to be added to the input signal. This is a convenient place to measure the added DC offset current.

Jumper JU4

When shorted, JU4 disables the MAX3761's offset correction. This allows DC parameter testing.

MAX3761 Evaluation Kit

Evaluates: MAX3761

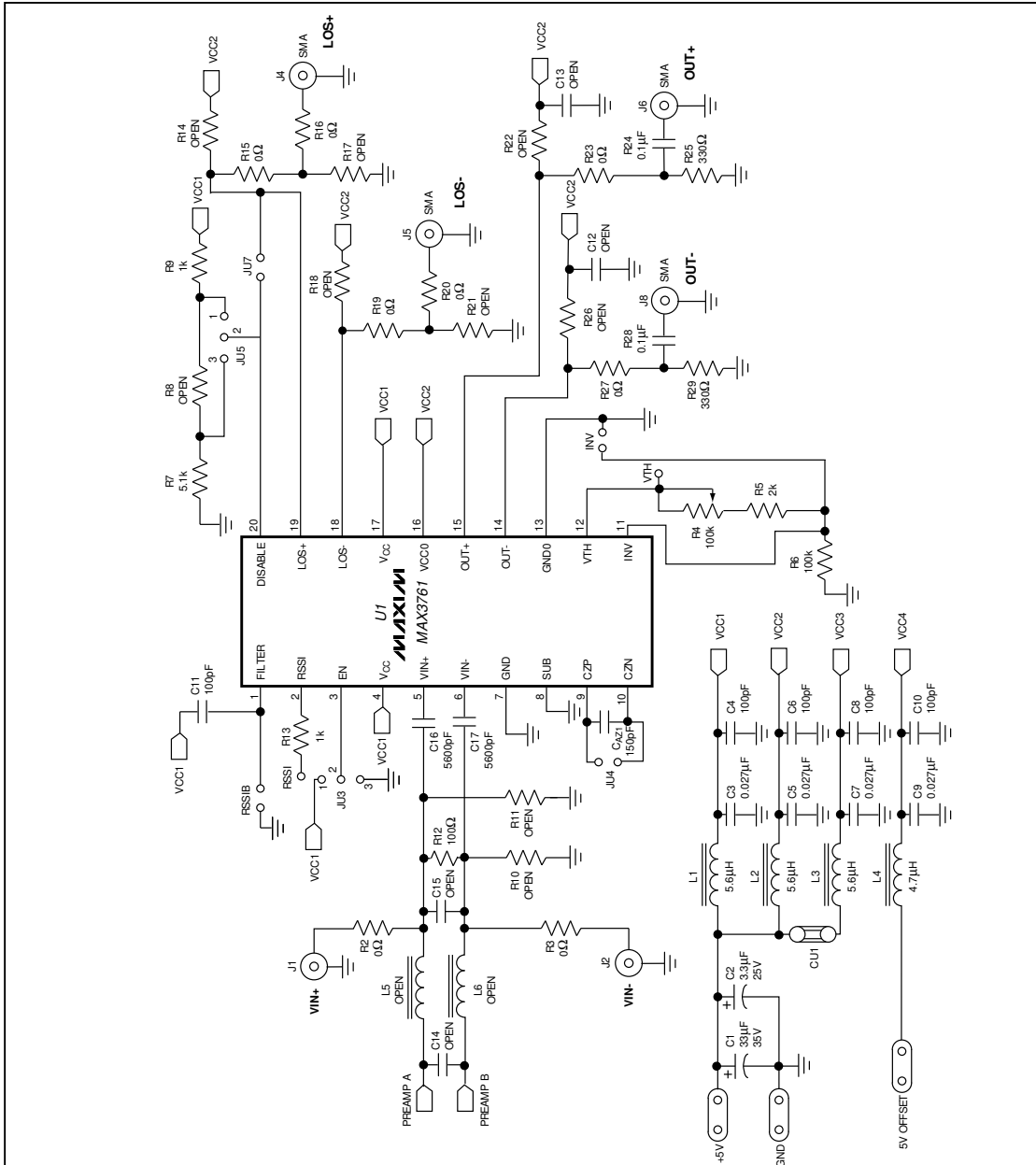

Figure 2. MAX3761 EV Kit Schematic

MAX3761 Evaluation Kit

Evaluates: MAX3761

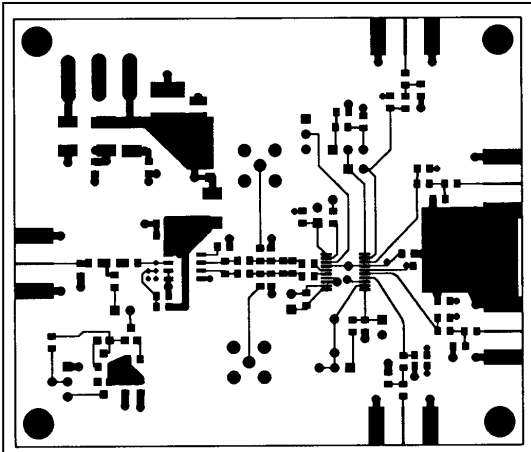

Figure 3. MAX3761 EV Kit PC Board Layout—Component Side

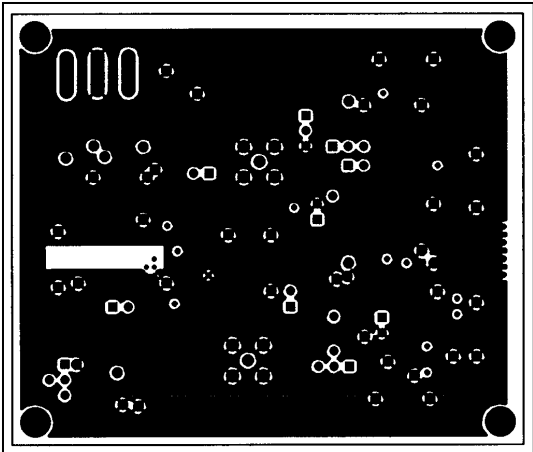

Figure 4. MAX3761 EV Kit PC Board Layout—Ground Plane

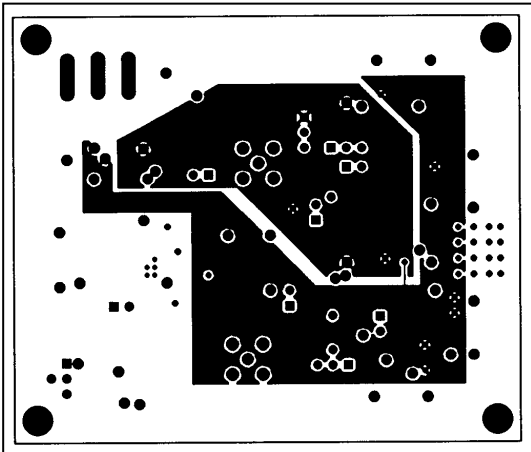

Figure 5. MAX3761 EV Kit PC Board Layout—Power Plane

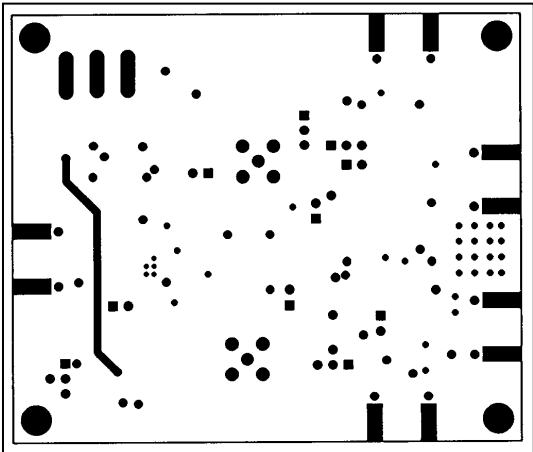

Figure 6. MAX3761 EV Kit PC Board Layout—Solder Side

Evaluates: MAX3761

MAX3761 Evaluation Kit

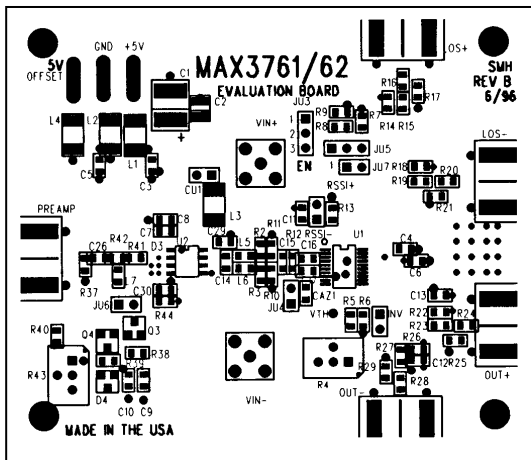

Figure 7. MAX3761 EV Kit Component Placement Guide

Maxim cannot assume responsibility for use of any circuitry other than circuitry entirely embodied in a Maxim product. No circuit patent licenses are implied. Maxim reserves the right to change the circuitry and specifications without notice at any time.

6 Maxim Integrated Products, 120 San Gabriel Drive, Sunnyvale, CA 94086 (408) 737-7600

© 1996 Maxim Integrated Products

Printed USA

MAXIM is a registered trademark of Maxim Integrated Products.