

# 16-BIT, 1-MSPS, PSEUDO-BIPOLAR, UNIPOLAR INPUT, MICROPOWER SAMPLING ANALOG-TO-DIGITAL CONVERTER WITH PARALLEL INTERFACE AND REFERENCE

## FEATURES

- 0 to 1 MSPS Sampling Rate
- $\pm 0.7$  LSB Typ,  $\pm 1$  LSB Max INL
- $\pm 0.4$  LSB Typ,  $\pm 0.75$  LSB Max DNL
- 16-Bit NMC Ensured Over Temperature
- $\pm 0.1$  mV Offset Error
- $\pm 0.15$  ppm/ $^{\circ}$ C Offset Error Drift
- $\pm 0.015$  %FSR Gain Error
- $\pm 0.7$  ppm/ $^{\circ}$ C Gain Error Drift
- 93 dB SNR, -110dB THD, 112dB SFDR
- Zero Latency
- Low Power: 220 mW at 1 MSPS
- Unipolar Input Range: 0 V to  $V_{ref}$
- Onboard Reference
- Onboard Reference Buffer
- High-Speed Parallel Interface
- Wide Digital Supply 2.7 V ~ 5.25 V
- 8-/16-Bit Bus Transfer

- 48-Pin 7x7 QFN Package

## APPLICATIONS

- Medical Instruments
- Optical Networking
- Transducer Interface
- High Accuracy Data Acquisition Systems
- Magnetometers

## DESCRIPTION

The ADS8471 is a 16-bit, 1-MSPS A/D converter with an internal 4.096-V reference and a pseudo-bipolar, unipolar input. The device includes a 16-bit capacitor-based SAR A/D converter with inherent sample and hold. The ADS8471 offers a full 16-bit interface or an 8-bit bus option using two read cycles.

The ADS8471 is available in a 48-lead 7x7 QFN package and is characterized over the industrial  $-40^{\circ}$ C to  $85^{\circ}$ C temperature range.

## HIGH-SPEED SAR CONVERTER FAMILY<sup>(1)</sup>

TYPE/SPEED	500 kHz	580 kHz	750 kHz	1 MHz	1.25 MHz	2 MHz	3 MHz	4MHz
18-Bit Pseudo-Diff	ADS8383	ADS8381						
		ADS8380 (S)						
18-Bit Pseudo-Bipolar, Fully Diff		ADS8382 (S)		ADS8482	ADS8484			
16-Bit Pseudo-Diff	ADS8327 (S)	ADS8370 (S)	ADS8371	ADS8471	ADS8401	ADS8411		
	ADS8328 (S)			ADS8329/30 (S)	ADS8405	ADS8410 (S)		
16-Bit Pseudo-Bipolar, Fully Diff		ADS8372 (S)		ADS8472	ADS8402	ADS8412		ADS8422
					ADS8406	ADS8413 (S)		
14-Bit Pseudo-Diff					ADS7890 (S)		ADS7891	
12-Bit Pseudo-Diff				ADS7886				ADS7881

(1) S: Serial

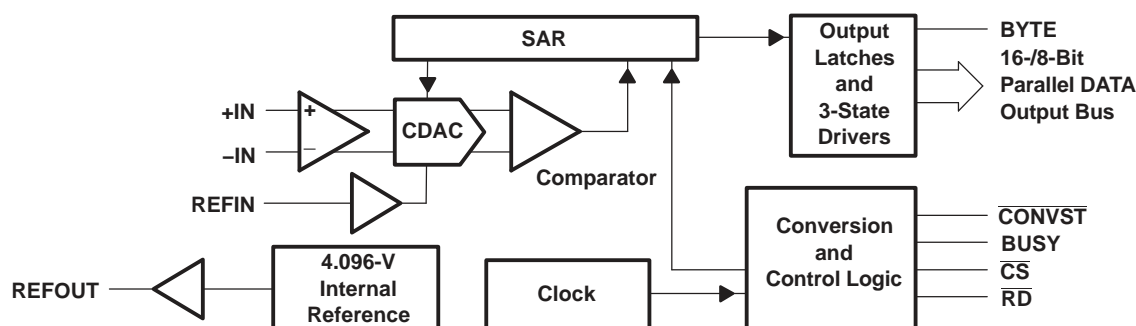

Please be aware that an important notice concerning availability, standard warranty, and use in critical applications of Texas Instruments semiconductor products and disclaimers thereto appears at the end of this data sheet.



These devices have limited built-in ESD protection. The leads should be shorted together or the device placed in conductive foam during storage or handling to prevent electrostatic damage to the MOS gates.

**ORDERING INFORMATION<sup>(1)</sup>**

MODEL	MAXIMUM INTEGRAL LINEARITY (LSB)	MAXIMUM DIFFERENTIAL LINEARITY (LSB)	NO MISSING CODES RESOLUTION (BIT)	PACKAGE TYPE	PACKAGE DESIGNATOR	TEMPERATURE RANGE	ORDERING INFORMATION	TRANSPORT MEDIA QTY.
ADS8471I	±2	±1	16	7x7 48 Pin QFN	RGZ	-40°C to 85°C	ADS8471IRGZT	Tape and reel 250
							ADS8471IRGZR	Tape and reel 1000
ADS8471IB	±1	±0.75	16	7x7 48 Pin QFN	RGZ	-40°C to 85°C	ADS8471IBRGZT	Tape and reel 250
							ADS8471IBRGZR	Tape and reel 1000

(1) For the most current package and ordering information, see the Package Option Addendum at the end of this document, or see the TI website at [www.ti.com](http://www.ti.com).

**ABSOLUTE MAXIMUM RATINGS<sup>(1)</sup>**

over operating free-air temperature range (unless otherwise noted)

		VALUE	UNIT
Voltage	+IN to AGND	-0.4 to +VA + 0.1	V
	-IN to AGND	-0.4 to 0.5	V
	+VA to AGND	-0.3 to 7	V
	+VBD to BDGND	-0.3 to 7	V
	+VA to +VBD	-0.3 to 2.55	V
Digital input voltage to BDGND		-0.3 to +VBD + 0.3	V
Digital output voltage to BDGND		-0.3 to +VBD + 0.3	V
T <sub>A</sub>	Operating free-air temperature range	-40 to 85	°C
T <sub>stg</sub>	Storage temperature range	-65 to 150	°C
Junction temperature (T <sub>J</sub> max)		150	°C
QFN package	Power dissipation	(T <sub>J</sub> Max - T <sub>A</sub> )/θ <sub>JA</sub>	
	θ <sub>JA</sub> thermal impedance	22	°C/W
Lead temperature, soldering	Vapor phase (60 sec)	215	°C
	Infrared (15 sec)	220	°C

(1) Stresses beyond those listed under *absolute maximum ratings* may cause permanent damage to the device. These are stress ratings only, and functional operation of the device at these or any other conditions beyond those indicated under *recommended operating conditions* is not implied. Exposure to absolute-maximum-rated conditions for extended periods may affect device reliability.

**SPECIFICATIONS**
 $T_A = -40^{\circ}\text{C}$  to  $85^{\circ}\text{C}$ ,  $+V_A = 5\text{ V}$ ,  $+V_{BD} = 3\text{ V}$  or  $5\text{ V}$ ,  $V_{ref} = 4.096\text{ V}$ ,  $f_{SAMPLE} = 1\text{ MSPS}$  (unless otherwise noted)

PARAMETER		TEST CONDITIONS	MIN	TYP	MAX	UNIT	
<b>ANALOG INPUT</b>							
Full-scale input voltage <sup>(1)</sup>		+IN – (–IN)	0		$V_{ref}$	V	
Absolute input voltage		+IN	–0.2		$V_{ref} + 0.2$	V	
		–IN	–0.2		0.2		
Input capacitance				65		pF	
Input leakage current				1		nA	
<b>SYSTEM PERFORMANCE</b>							
Resolution				16		Bits	
No missing codes		ADS8471I		16		Bits	
		ADS8471IB		16			
INL	Integral linearity <sup>(2)</sup> <sup>(3)</sup>	ADS8471I	–2	$\pm 0.7$	2	LSB (16 bit)	
		ADS8471IB	–1	$\pm 0.7$	1		
DNL	Differential linearity	ADS8471I	–1	$\pm 0.4$	1	LSB (16 bit)	
		ADS8471IB	–0.75	$\pm 0.4$	0.75		
Offset error <sup>(4)</sup>		ADS8471I	–0.5	$\pm 0.1$	0.5	mV	
		ADS8471IB	–0.5	$\pm 0.1$	0.5		
Offset error temperature drift		ADS8471I		$\pm 0.15$		ppm/ $^{\circ}\text{C}$	
		ADS8471IB		$\pm 0.15$			
Gain error <sup>(4)</sup> <sup>(5)</sup>		ADS8471I	$V_{ref} = 4.096\text{ V}$	–0.075	$\pm 0.015$	0.075	%FS
		ADS8471IB	$V_{ref} = 4.096\text{ V}$	–0.075	$\pm 0.015$	0.075	%FS
Gain error temperature drift		ADS8471I		$\pm 0.7$		ppm/ $^{\circ}\text{C}$	
		ADS8471IB		$\pm 0.7$			
Noise				25		$\mu\text{V}$ RMS	
Power supply rejection ratio		At FFFFh output code		60		dB	
<b>SAMPLING DYNAMICS</b>							
Conversion time				670	700	ns	
Acquisition time			270	300		ns	
Throughput rate					1	MHz	
Aperture delay				4		ns	
Aperture jitter				5		ps	
Step response				150		ns	
Overvoltage recovery				150		ns	

- (1) Ideal input span, does not include gain or offset error.
- (2) LSB means least significant bit
- (3) This is endpoint INL, not best fit.
- (4) Measured relative to an ideal full-scale input [+IN – (–IN)] of 8.192 V
- (5) This specification does not include the internal reference voltage error and drift.

**SPECIFICATIONS (Continued)**

$T_A = -40^{\circ}\text{C}$  to  $85^{\circ}\text{C}$ ,  $+VA = 5\text{ V}$ ,  $+VBD = 3\text{ V}$  or  $5\text{ V}$ ,  $V_{\text{ref}} = 4.096\text{ V}$ ,  $f_{\text{SAMPLE}} = 1\text{ MSPS}$  (unless otherwise noted)

PARAMETER		TEST CONDITIONS	MIN	TYP	MAX	UNIT
<b>DYNAMIC CHARACTERISTICS</b>						
THD	Total harmonic distortion <sup>(1)</sup>	ADS8471I	$V_{\text{IN}} = 4 V_{\text{pp}}$ at 2 kHz	-110	dB	
		ADS8471IB		-112		
		ADS8471I	$V_{\text{IN}} = 4 V_{\text{pp}}$ at 20 kHz	-105		
		ADS8471IB		-107		
		ADS8471I	$V_{\text{IN}} = 4 V_{\text{pp}}$ at 100 kHz	-101		
		ADS8471IB		-102		
SNR	Signal-to-noise ratio <sup>(1)</sup>	ADS8471I	$V_{\text{IN}} = 4 V_{\text{pp}}$ at 2 kHz	93	dB	
		ADS8471IB		93		
		ADS8471I	$V_{\text{IN}} = 4 V_{\text{pp}}$ at 20 kHz	92.5		
		ADS8471IB		92.7		
		ADS8471I	$V_{\text{IN}} = 4 V_{\text{pp}}$ at 100 kHz	91.5		
		ADS8471IB		91.6		
SINAD	Signal-to-noise + distortion <sup>(1)</sup>	ADS8471I	$V_{\text{IN}} = 4 V_{\text{pp}}$ at 2 kHz	93	dB	
		ADS8471IB		93		
		ADS8471I	$V_{\text{IN}} = 4 V_{\text{pp}}$ at 20 kHz	92.4		
		ADS8471IB		92.6		
		ADS8471I	$V_{\text{IN}} = 4 V_{\text{pp}}$ at 100 kHz	91		
		ADS8471IB		91.1		
SFDR	Spurious free dynamic range <sup>(1)</sup>	ADS8471I	$V_{\text{IN}} = 4 V_{\text{pp}}$ at 2 kHz	112	dB	
		ADS8471IB		114		
		ADS8471I	$V_{\text{IN}} = 4 V_{\text{pp}}$ at 20 kHz	107		
		ADS8471IB		109		
		ADS8471I	$V_{\text{IN}} = 4 V_{\text{pp}}$ at 100 kHz	102		
		ADS8471IB		103		
-3dB Small signal bandwidth				15		MHz
<b>VOLTAGE REFERENCE INPUT</b>						
$V_{\text{ref}}$	Reference voltage at REFIN,		3.0	4.096	+VA - 0.8	V
	Reference resistance <sup>(2)</sup>			500		k $\Omega$
	Reference current drain	$f_s = 1\text{ MHz}$			1	mA

(1) Calculated on the first nine harmonics of the input frequency.

(2) Can vary  $\pm 20\%$

**SPECIFICATIONS (Continued)**
 $T_A = -40\text{C}$  to  $85\text{C}$ ,  $+VA = 5\text{ V}$ ,  $+VBD = 3\text{ V}$  or  $5\text{ V}$ ,  $V_{ref} = 4.096\text{ V}$ ,  $f_{SAMPLE} = 1\text{ MSPS}$  (unless otherwise noted)

PARAMETER		TEST CONDITIONS	MIN	TYP	MAX	UNIT
<b>INTERNAL REFERENCE OUTPUT</b>						
Internal reference start-up time		From 95% (+VA), with 1- $\mu\text{F}$ storage capacitor			120	ms
$V_{ref}$	Reference voltage range	$I_O = 0\text{ A}$	4.081	4.096	4.111	V
Source current		Static load			10	$\mu\text{A}$
Line regulation		$+VA = 4.75\text{ V}$ to $5.25\text{ V}$		60		$\mu\text{V}$
Drift		$I_O = 0\text{ A}$		$\pm 6$		PPM/ $^{\circ}\text{C}$
<b>DIGITAL INPUT/OUTPUT</b>						
Logic family – CMOS						
$V_{IH}$	High-level input voltage	$I_{IH} = 5\text{ }\mu\text{A}$	$+VBD - 1$		$+VBD + 0.3$	V
$V_{IL}$	Low-level input voltage	$I_{IL} = 5\text{ }\mu\text{A}$	-0.3		0.8	
$V_{OH}$	High-level output voltage	$I_{OH} = 2\text{ TTL loads}$	$+VBD - 0.6$			
$V_{OL}$	Low-level output voltage	$I_{OL} = 2\text{ TTL loads}$			0.4	
Data format – Straight binary						
<b>POWER SUPPLY REQUIREMENTS</b>						
Power supply voltage	+VBD		2.7	3.3	5.25	V
	+VA		4.75	5	5.25	V
Supply current <sup>(1)</sup>		$f_s = 1\text{ MHz}$		44	48	mA
Power dissipation <sup>(1)</sup>		$f_s = 1\text{ MHz}$		220	240	mW
<b>TEMPERATURE RANGE</b>						
Operating free-air			-40		85	$^{\circ}\text{C}$

(1) This includes only +VA current. +VBD current is typical 1 mA with 5-pF load capacitance on all output pins.

## TIMING CHARACTERISTICS

All specifications typical at  $-40^{\circ}\text{C}$  to  $85^{\circ}\text{C}$ ,  $+VA = +VBD = 5\text{ V}$  <sup>(1)</sup> <sup>(2)</sup> <sup>(3)</sup>

PARAMETER		MIN	TYP	MAX	UNIT
$t_{(\text{CONV})}$	Conversion time		670	700	ns
$t_{(\text{ACQ})}$	Acquisition time	270	300		ns
$t_{(\text{HOLD})}$	Sample capacitor hold time			25	ns
$t_{\text{pd1}}$	$\overline{\text{CONVST}}$ low to BUSY high			40	ns
$t_{\text{pd2}}$	Propagation delay time, end of conversion to BUSY low			15	ns
$t_{\text{pd3}}$	Propagation delay time, start of convert state to rising edge of BUSY			15	ns
$t_{\text{w1}}$	Pulse duration, $\overline{\text{CONVST}}$ low	40			ns
$t_{\text{su1}}$	Setup time, $\overline{\text{CS}}$ low to $\overline{\text{CONVST}}$ low	20			ns
$t_{\text{w2}}$	Pulse duration, $\overline{\text{CONVST}}$ high	20			ns
	$\overline{\text{CONVST}}$ falling edge jitter			10	ps
$t_{\text{w3}}$	Pulse duration, BUSY signal low	$t_{(\text{ACQ})\text{min}}$			ns
$t_{\text{w4}}$	Pulse duration, BUSY signal high			700	ns
$t_{\text{h1}}$	Hold time, first data bus transition ( $\overline{\text{RD}}$ low, or $\overline{\text{CS}}$ low for read cycle, or BYTE input changes) after $\overline{\text{CONVST}}$ low	40			ns
$t_{\text{d1}}$	Delay time, $\overline{\text{CS}}$ low to $\overline{\text{RD}}$ low	0			ns
$t_{\text{su2}}$	Setup time, $\overline{\text{RD}}$ high to $\overline{\text{CS}}$ high	0			ns
$t_{\text{w5}}$	Pulse duration, $\overline{\text{RD}}$ low	50			ns
$t_{\text{en}}$	Enable time, $\overline{\text{RD}}$ low (or $\overline{\text{CS}}$ low for read cycle) to data valid			20	ns
$t_{\text{d2}}$	Delay time, data hold from $\overline{\text{RD}}$ high	5			ns
$t_{\text{d3}}$	Delay time, BYTE rising edge or falling edge to data valid	10		20	ns
$t_{\text{w6}}$	Pulse duration, $\overline{\text{RD}}$ high	20			ns
$t_{\text{w7}}$	Pulse duration, $\overline{\text{CS}}$ high	20			ns
$t_{\text{h2}}$	Hold time, last $\overline{\text{RD}}$ (or $\overline{\text{CS}}$ for read cycle) rising edge to $\overline{\text{CONVST}}$ falling edge	50			ns
$t_{\text{pd4}}$	Propagation delay time, BUSY falling edge to next $\overline{\text{RD}}$ (or $\overline{\text{CS}}$ for read cycle) falling edge	0			ns
$t_{\text{d4}}$	Delay time, BYTE edge to edge skew	0			ns
$t_{\text{su3}}$	Setup time, BYTE transition to $\overline{\text{RD}}$ falling edge	10			ns
$t_{\text{h3}}$	Hold time, BYTE transition to $\overline{\text{RD}}$ falling edge	10			ns
$t_{\text{dis}}$	Disable time, $\overline{\text{RD}}$ high ( $\overline{\text{CS}}$ high for read cycle) to 3-stated data bus			20	ns
$t_{\text{d5}}$	Delay time, BUSY low to MSB data valid delay			0	ns
$t_{\text{d6}}$	Delay time, $\overline{\text{CS}}$ rising edge to BUSY falling edge	50			ns
$t_{\text{d7}}$	Delay time, BUSY falling edge to $\overline{\text{CS}}$ rising edge	50			ns
$t_{\text{su5}}$	BYTE transition setup time, from BYTE transition to next BYTE transition	50			ns
$t_{\text{su}(\text{ABORT})}$	Setup time from the falling edge of $\overline{\text{CONVST}}$ (used to start the valid conversion) to the next falling edge of $\overline{\text{CONVST}}$ (when $\overline{\text{CS}} = 0$ and $\overline{\text{CONVST}}$ are used to abort) or to the next falling edge of $\overline{\text{CS}}$ (when $\overline{\text{CS}}$ is used to abort).	60		600	ns

(1) All input signals are specified with  $t_r = t_f = 5\text{ ns}$  (10% to 90% of  $+VBD$ ) and timed from a voltage level of  $(V_{\text{IL}} + V_{\text{IH}})/2$ .

(2) See timing diagrams.

(3) All timing are measured with 20-pF equivalent loads on all data bits and BUSY pins.

## TIMING CHARACTERISTICS

All specifications typical at  $-40^{\circ}\text{C}$  to  $85^{\circ}\text{C}$ ,  $+V_A = 5\text{ V}$   $+V_{BD} = 3\text{ V}$  <sup>(1)</sup> <sup>(2)</sup> <sup>(3)</sup>

PARAMETER		MIN	TYP	MAX	UNIT
$t_{(\text{CONV})}$	Conversion time		67	700	ns
$t_{(\text{ACQ})}$	Acquisition time	270	300		ns
$t_{(\text{HOLD})}$	Sample capacitor hold time			25	ns
$t_{\text{pd1}}$	$\overline{\text{CONVST}}$ low to BUSY high			40	ns
$t_{\text{pd2}}$	Propagation delay time, end of conversion to BUSY low			25	ns
$t_{\text{pd3}}$	Propagation delay time, start of convert state to rising edge of BUSY			25	ns
$t_{\text{w1}}$	Pulse duration, $\overline{\text{CONVST}}$ low	40			ns
$t_{\text{su1}}$	Setup time, $\overline{\text{CS}}$ low to $\overline{\text{CONVST}}$ low	20			ns
$t_{\text{w2}}$	Pulse duration, CONVST high	20			ns
	$\overline{\text{CONVST}}$ falling edge jitter			10	ps
$t_{\text{w3}}$	Pulse duration, BUSY signal low	$t_{(\text{ACQ})\text{min}}$			ns
$t_{\text{w4}}$	Pulse duration, BUSY signal high			700	ns
$t_{\text{h1}}$	Hold time, first data bus transition ( $\overline{\text{RD}}$ low, or $\overline{\text{CS}}$ low for read cycle, or BYTE input changes) after $\overline{\text{CONVST}}$ low	40			ns
$t_{\text{d1}}$	Delay time, $\overline{\text{CS}}$ low to $\overline{\text{RD}}$ low	0			ns
$t_{\text{su2}}$	Setup time, $\overline{\text{RD}}$ high to $\overline{\text{CS}}$ high	0			ns
$t_{\text{w5}}$	Pulse duration, $\overline{\text{RD}}$ low	50			ns
$t_{\text{en}}$	Enable time, $\overline{\text{RD}}$ low (or $\overline{\text{CS}}$ low for read cycle) to data valid			30	ns
$t_{\text{d2}}$	Delay time, data hold from $\overline{\text{RD}}$ high	5			ns
$t_{\text{d3}}$	Delay time, BYTE rising edge or falling edge to data valid	10		30	ns
$t_{\text{w6}}$	Pulse duration, $\overline{\text{RD}}$ high	20			ns
$t_{\text{w7}}$	Pulse duration, $\overline{\text{CS}}$ high	20			ns
$t_{\text{h2}}$	Hold time, last $\overline{\text{RD}}$ (or $\overline{\text{CS}}$ for read cycle) rising edge to $\overline{\text{CONVST}}$ falling edge	50			ns
$t_{\text{pd4}}$	Propagation delay time, BUSY falling edge to next $\overline{\text{RD}}$ (or $\overline{\text{CS}}$ for read cycle) falling edge	0			ns
$t_{\text{d4}}$	Delay time, BYTE edge to edge skew	0			ns
$t_{\text{su3}}$	Setup time, BYTE or transition to $\overline{\text{RD}}$ falling edge	10			ns
$t_{\text{h3}}$	Hold time, BYTE or transition to $\overline{\text{RD}}$ falling edge	10			ns
$t_{\text{dis}}$	Disable time, $\overline{\text{RD}}$ high ( $\overline{\text{CS}}$ high for read cycle) to 3-stated data bus			30	ns
$t_{\text{d5}}$	Delay time, BUSY low to MSB data valid delay			0	ns
$t_{\text{d6}}$	Delay time, $\overline{\text{CS}}$ rising edge to BUSY falling edge	50			ns
$t_{\text{d7}}$	Delay time, BUSY falling edge to $\overline{\text{CS}}$ rising edge	50			ns
$t_{\text{su5}}$	BYTE transition setup time, from BYTE transition to next BYTE transition	50			ns
$t_{\text{su(ABORT)}}$	Setup time from the falling edge of $\overline{\text{CONVST}}$ (used to start the valid conversion) to the next falling edge of $\overline{\text{CONVST}}$ (when $\text{CS} = 0$ and $\overline{\text{CONVST}}$ are used to abort) or to the next falling edge of $\overline{\text{CS}}$ (when $\overline{\text{CS}}$ is used to abort).	60		600	ns

(1) All input signals are specified with  $t_r = t_f = 5\text{ ns}$  (10% to 90% of  $+V_{BD}$ ) and timed from a voltage level of  $(V_{IL} + V_{IH})/2$ .

(2) See timing diagrams.

(3) All timing are measured with 20-pF equivalent loads on all data bits and BUSY pins.

### PIN ASSIGNMENTS

RGZ PACKAGE  
(TOP VIEW)

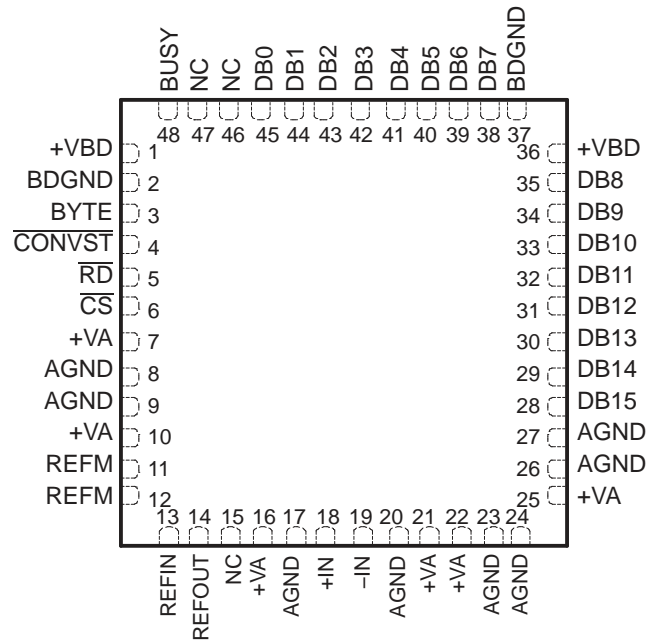

NC – No internal connection

NOTE: The package thermal pad must be soldered to the printed circuit board for thermal and mechanical performance.

### TERMINAL FUNCTIONS

NAME	NO	I/O	DESCRIPTION		
AGND	8, 9, 17, 20, 23, 24, 26, 27	–	Analog ground		
BDGND	2, 37	–	Digital ground for bus interface digital supply		
BUSY	48	O	Status output. High when a conversion is in progress.		
BYTE	3	I	Byte select input. Used for 8-bit bus reading. 0: No fold back 1: Low byte D[9:2] of the 16 most significant bits is folded back to high byte of the 16 most significant pins DB[17:10].		
CONVST	4	I	Convert start. The falling edge of this input ends the acquisition period and starts the hold period.		
CS	6	I	Chip select. The falling edge of this input starts the acquisition period.		
Data Bus			8-BIT BUS		16-BIT BUS
			BYTE = 0	BYTE = 1	BYTE = 0
DB15	28	O	D15 (MSB)	D7	D15(MSB)
DB14	29	O	D14	D6	D14
DB13	30	O	D13	D5	D13
DB12	31	O	D12	D4	D12
DB11	32	O	D11	D3	D11
DB10	33	O	D10	D2	D10
DB9	34	O	D9	All ones	D9
DB8	35	O	D8	All ones	D8
DB7	38	O	D7	All ones	D7
DB6	39	O	D6	All ones	D6
DB5	40	O	D5	All ones	D5
DB4	41	O	D4	All ones	D4
DB3	42	O	D3	All ones	D3



TERMINAL FUNCTIONS (continued)

NAME	NO	I/O	DESCRIPTION		
DB2	43	O	D2	All ones	D2
DB1	44	O	D1	All ones	D1
DB0	45	O	D0 (LSB)	All ones	D0 (LSB)
-IN	19	I	Inverting input channel		
+IN	18	I	Noninverting input channel		
NC	15, 46, 47		No connection		
REFIN	13	I	Reference input		
REFOUT	14	O	Reference output. Add 1- $\mu$ F capacitor between the REFOUT pin and REFM pin when internal reference is used.		
REFM	11, 12	I	Reference ground		
$\overline{RD}$	5	I	Synchronization pulse for the parallel output. When $\overline{CS}$ is low, this serves as output enable and puts the previous conversion results on the bus.		
+VA	7, 10, 16, 21, 22, 25	-	Analog power supplies, 5-V DC		
+VBD	1, 36	-	Digital power supply for bus		

TYPICAL CHARACTERISTICS

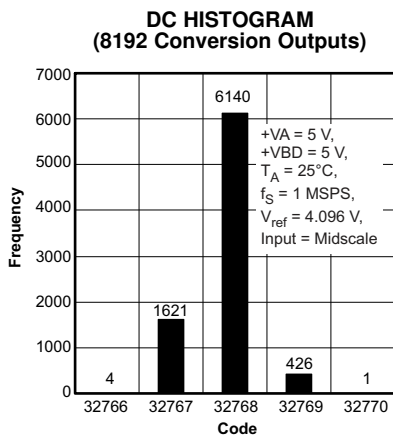

Figure 1.

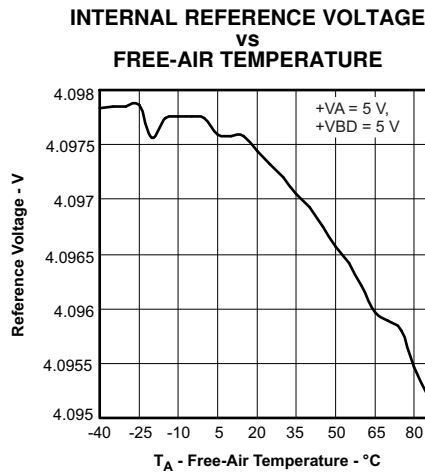

Figure 2.

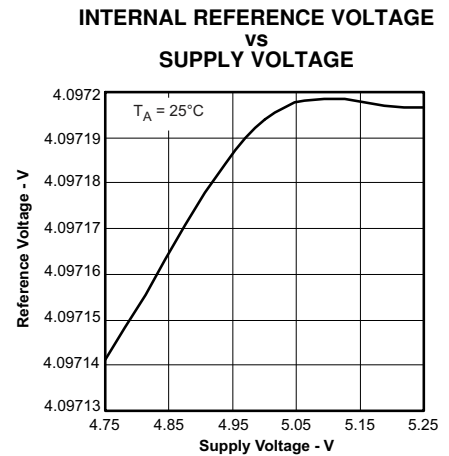

Figure 3.

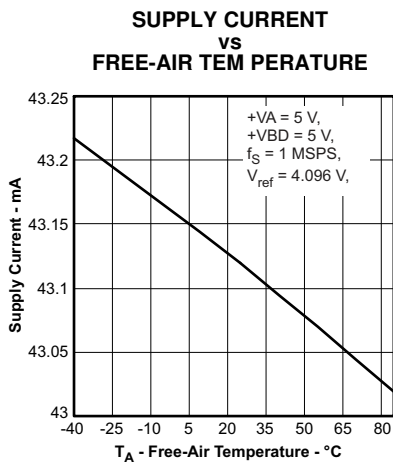

Figure 4.

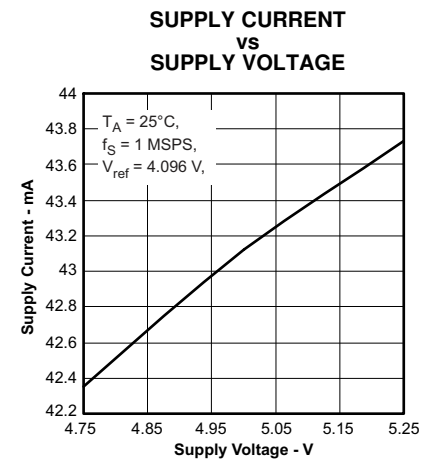

Figure 5.

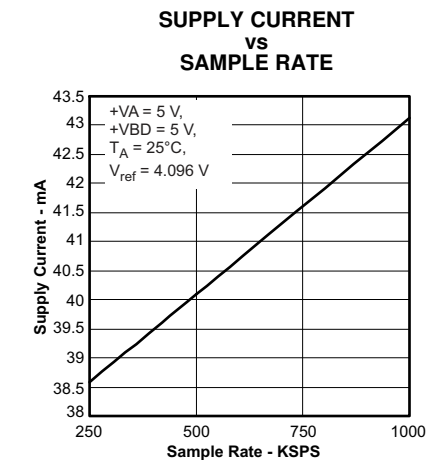
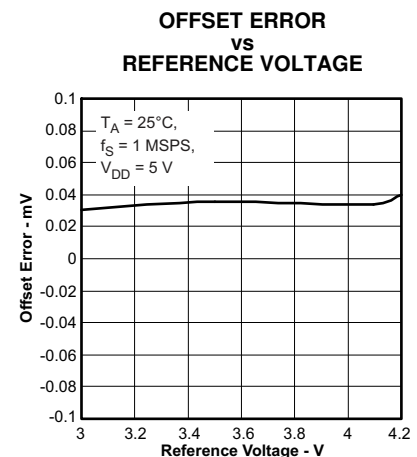
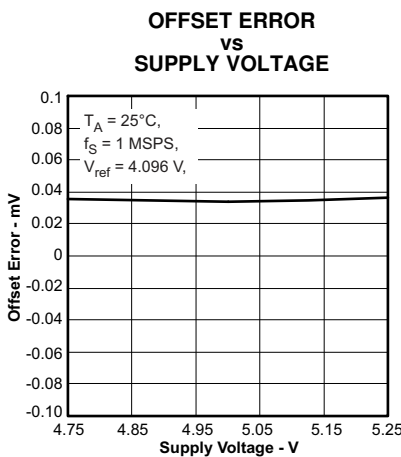
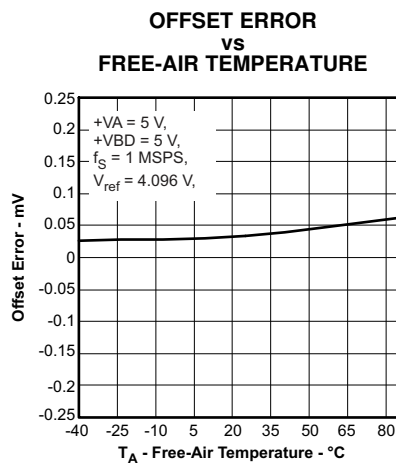
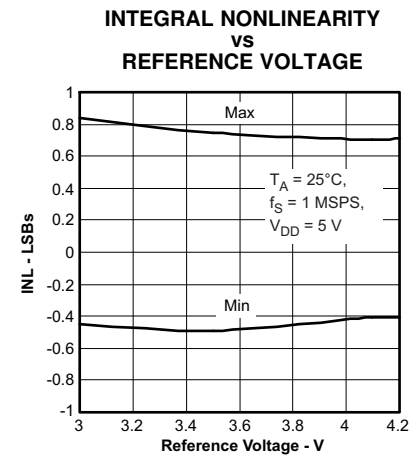
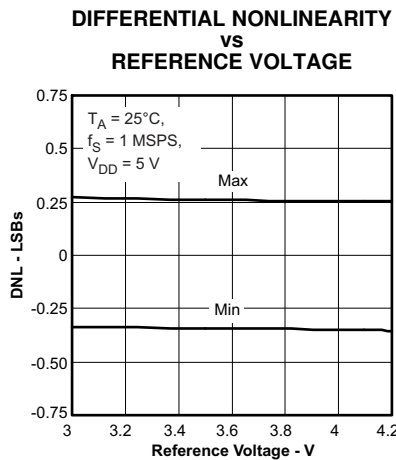
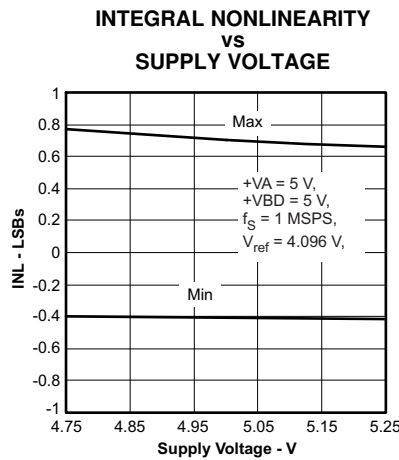
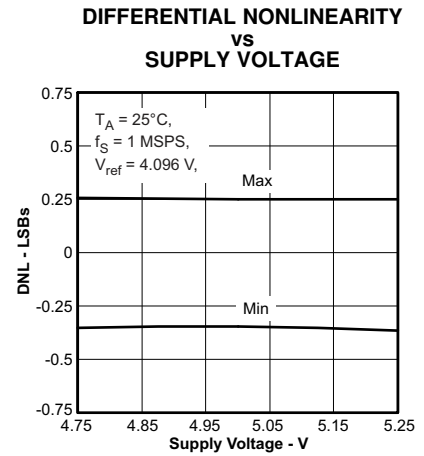
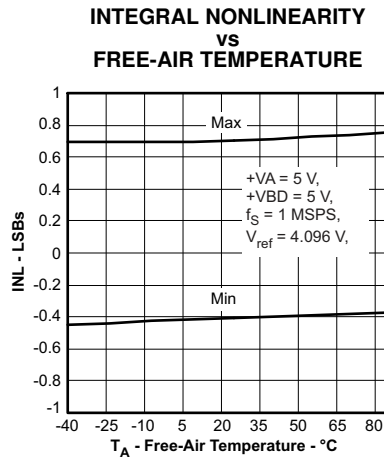
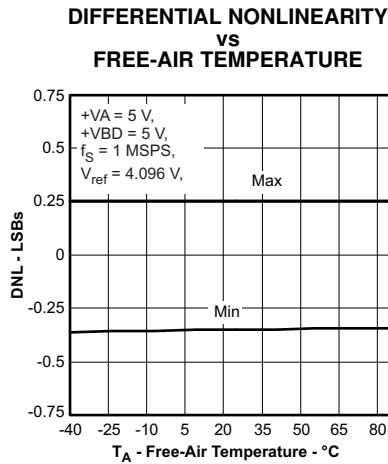

Figure 6.

TYPICAL CHARACTERISTICS (continued)



TYPICAL CHARACTERISTICS (continued)

GAIN ERROR  
VS  
SUPPLY VOLTAGE

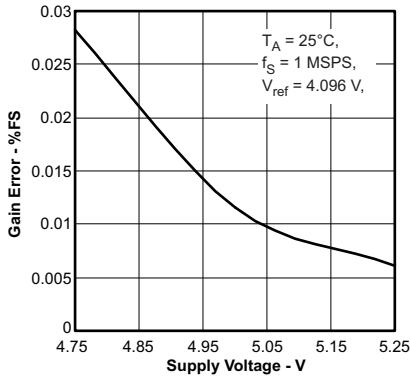

Figure 16.

GAIN ERROR  
VS  
FREE-AIR TEMPERATURE

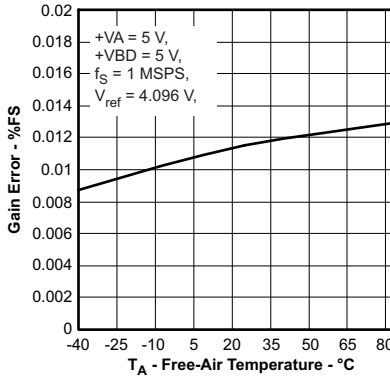

Figure 17.

GAIN ERROR  
VS  
REFERENCE VOLTAGE

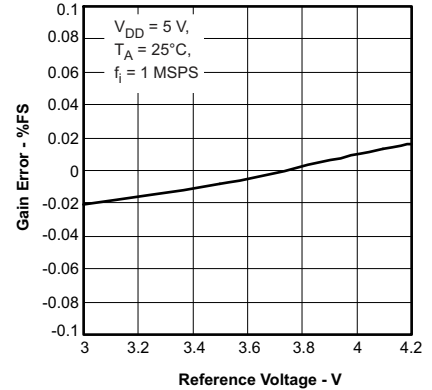

Figure 18.

OFFSET ERROR TEMPERATURE  
DRIFT DISTRIBUTION (25 Samples)

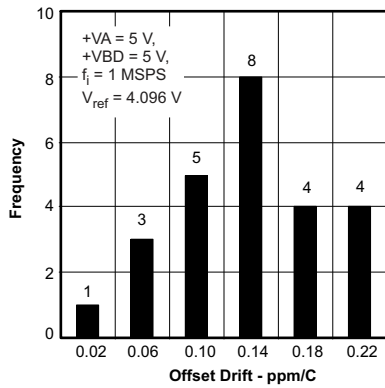

Figure 19.

GAIN ERROR TEMPERATURE  
DRIFT DISTRIBUTION (25 Samples)

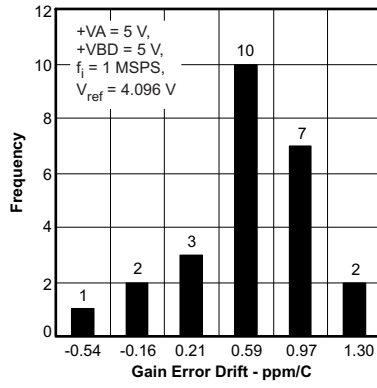

Figure 20.

TOTAL HARMONIC DISTORTION  
VS  
REFERENCE VOLTAGE

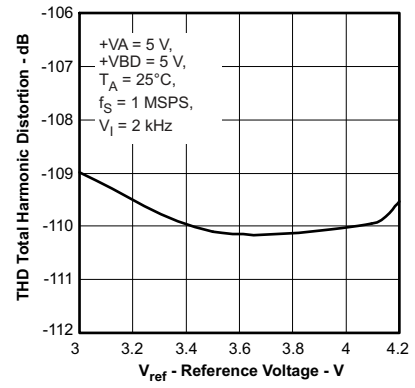

Figure 21.

SIGNAL-TO-NOISE RATIO  
VS  
REFERENCE VOLTAGE

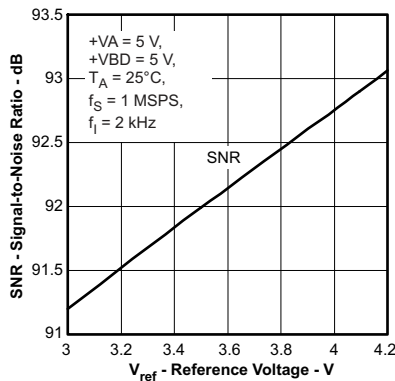

Figure 22.

SIGNAL-TO-NOISE + DISTORTION  
VS  
REFERENCE VOLTAGE

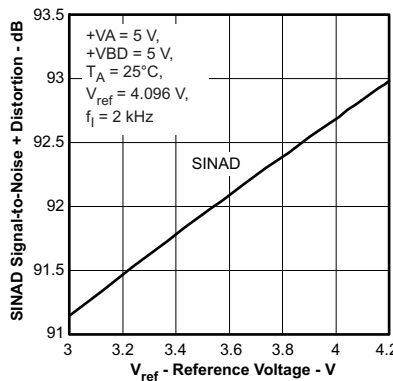

Figure 23.

TOTAL HARMONIC DISTORTION  
VS  
FREE-AIR TEMPERATURE

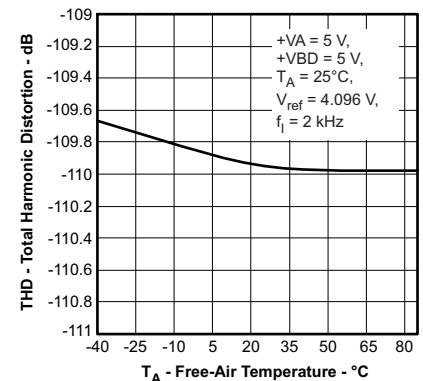

Figure 24.

TYPICAL CHARACTERISTICS (continued)

SPURIOUS FREE DYNAMIC RANGE  
vs  
FREE-AIR TEMPERATURE

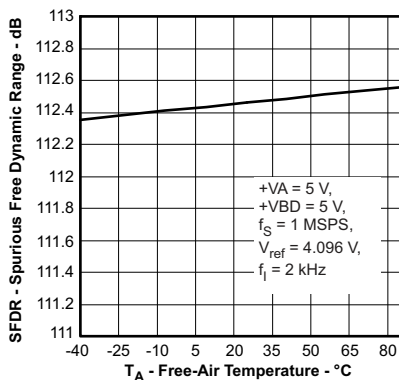

Figure 25.

SIGNAL-TO-NOISE RATIO  
vs  
FREE-AIR TEMPERATURE

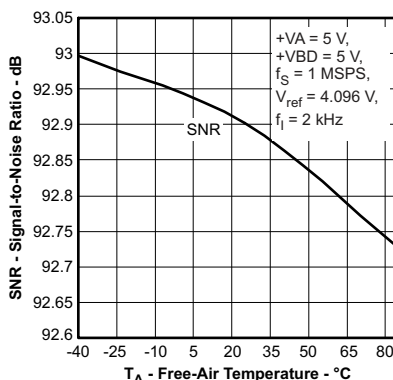

Figure 26.

SIGNAL-TO-NOISE + DISTORTION  
vs  
FREE-AIR TEMPERATURE

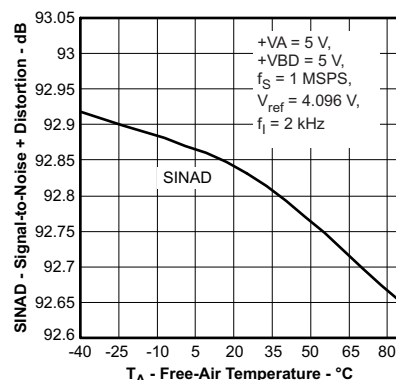

Figure 27.

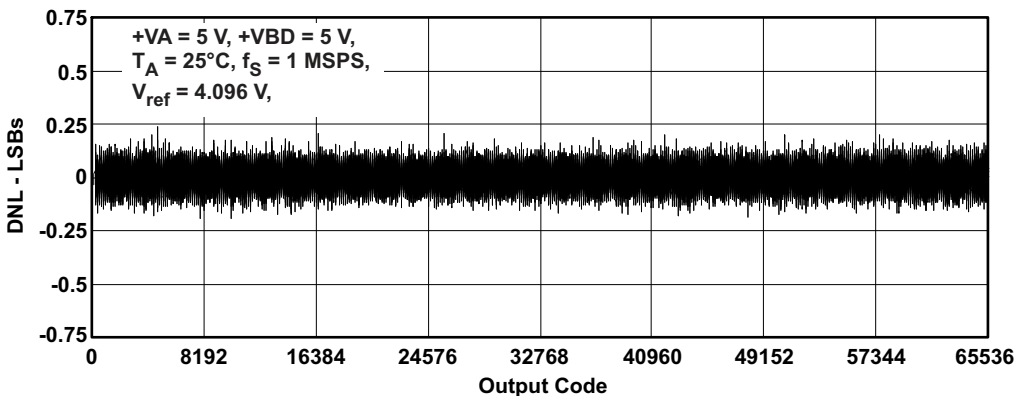

Figure 28.

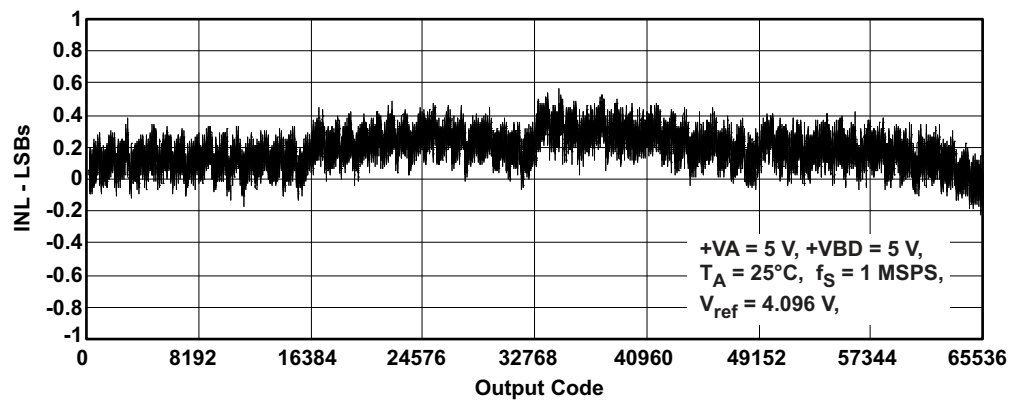

Figure 29.

TYPICAL CHARACTERISTICS (continued)

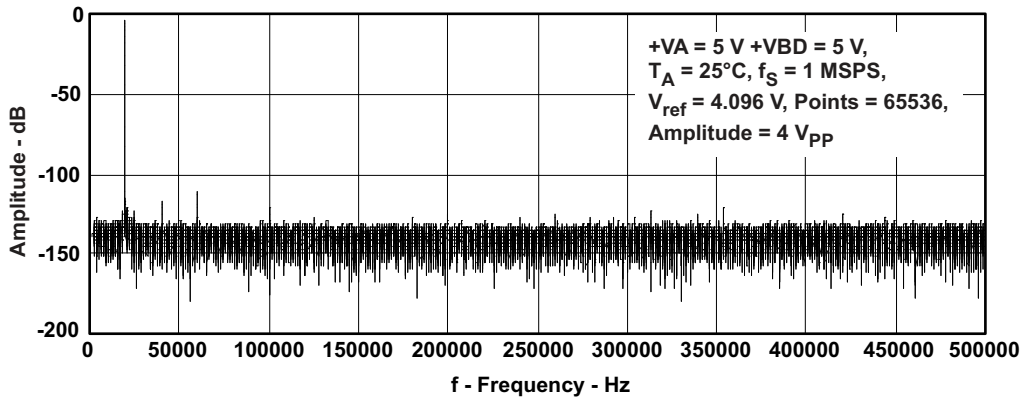
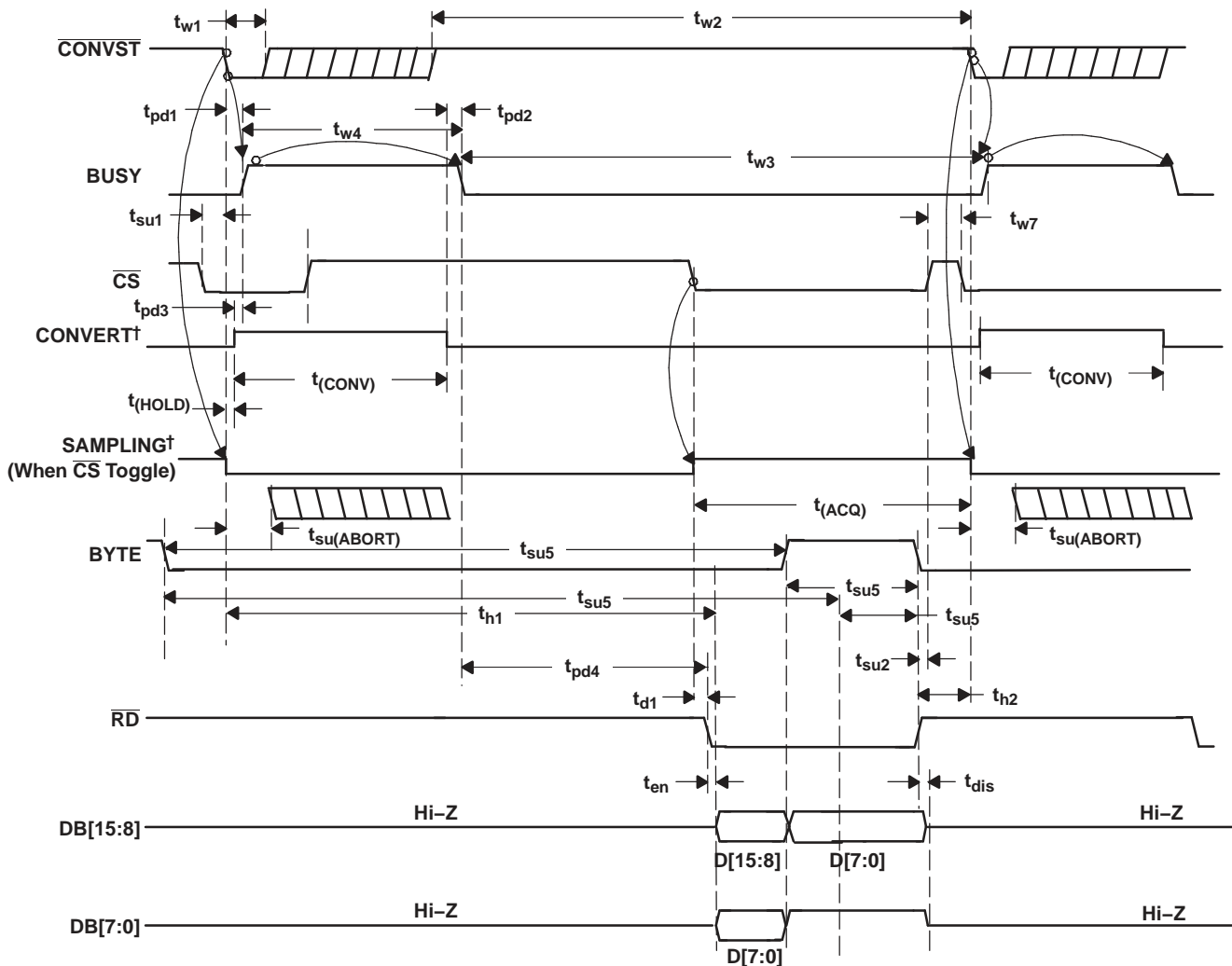

Figure 30.

TIMING DIAGRAMS



†Signal internal to device

Figure 31. Timing for Conversion and Acquisition Cycles With  $\overline{CS}$  and  $\overline{RD}$  Toggling





TYPICAL CHARACTERISTICS (continued)

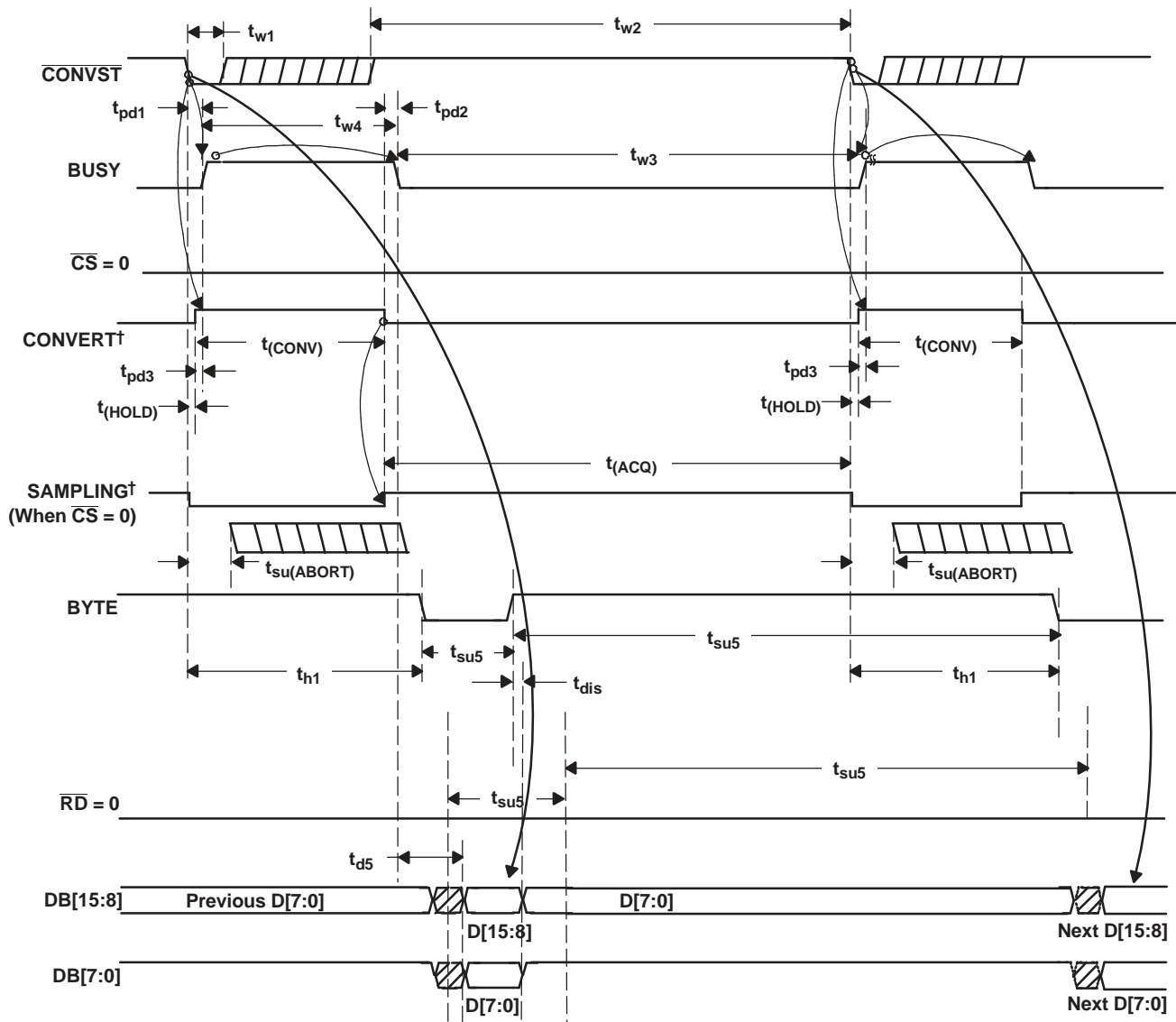

†Signal internal to device

Figure 34. Timing for Conversion and Acquisition Cycles With CS and RD Tied to BDGND - Auto Read



**TYPICAL CHARACTERISTICS (continued)**

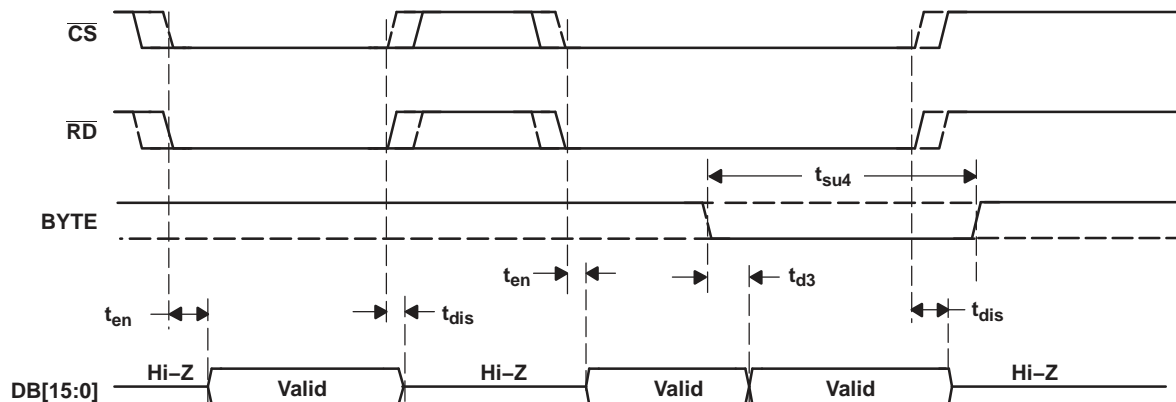

**Figure 35. Detailed Timing for Read Cycles**

APPLICATION INFORMATION

ADS8471 TO A HIGH PERFORMANCE DSP INTERFACE

Figure 36 shows a parallel interface between the ADS8471 and a Texas instruments high performance DSP such as the TMS320C6713 using the full 16-bit bus. The ADS8471 is mapped onto the  $\overline{CE2}$  memory space of the TMS320C6713 DSP. The read and reset signals are generated by using a 3-to-8 decoder. A read operation from the address 0xA000C000 generates a pulse on the  $\overline{RD}$  pin of the data converter, whereas a read operation from word address 0xA0014000 generates a pulse on the  $\overline{RESET/PD1}$  pin. The  $\overline{CE2}$  signal of the DSP acts as  $\overline{CS}$  (chip select) for the converter. As the TMS320C6713 features a 32-bit external memory interface, the BYTE input of the converter can be tied permanently low, disabling the foldback of the data bus. The BUSY signal of the ADS8471 is applied to the  $\overline{EXT\_INT6}$  interrupt input of the DSP, enabling the EDMA controller to react on the falling edge of this signal and to collect the conversion result. The TOUT1 (timer out 1) pin of the TMS320C6713 is used to source the CONVST signal of the converter.

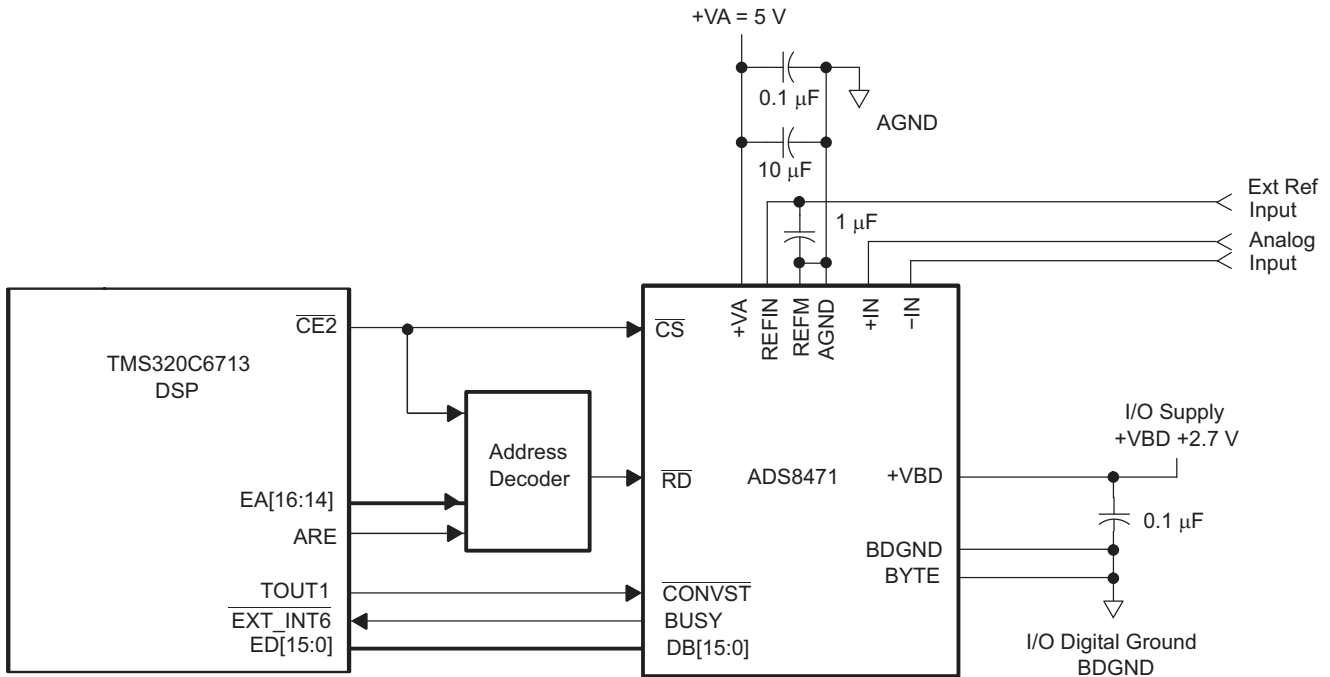

Figure 36. ADS8471 Application Circuitry

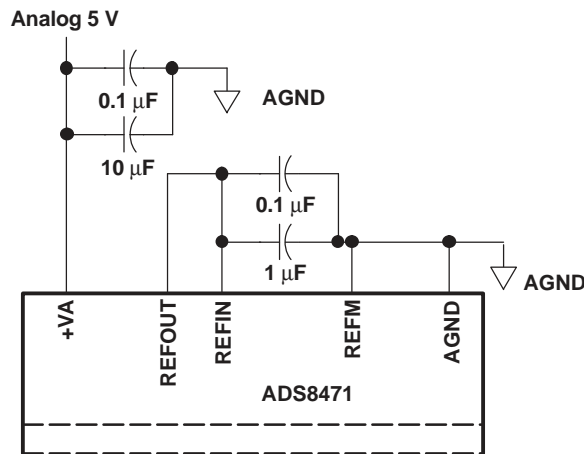

Figure 37. ADS8471 Using Internal Reference

## PRINCIPLES OF OPERATION

The ADS8471 is a high-speed successive approximation register (SAR) analog-to-digital converter (ADC). The architecture is based on charge redistribution which inherently includes a sample/hold function. See [Figure 36](#) for the application circuit for the ADS8471.

The conversion clock is generated internally. The conversion time of 700 ns is capable of sustaining a 1-MHz throughput.

The analog input is provided to two input pins: +IN and –IN. When a conversion is initiated, the differential input on these pins is sampled on the internal capacitor array. While a conversion is in progress, both inputs are disconnected from any internal function.

## REFERENCE

The ADS8471 can operate with an external reference with a range from 3.0 V to 4.2 V. The reference voltage on the input pin 13 (REFIN) of the converter is internally buffered. A clean, low noise, well-decoupled reference voltage on this pin is required to ensure good performance of the converter. A low noise band-gap reference like the REF5040 can be used to drive this pin. A 0.1- $\mu$ F decoupling capacitor is required between REFIN and REFM pins (pin 13 and pin 12) of the converter. This capacitor should be placed as close as possible to the pins of the device. Designers should strive to minimize the routing length of the traces that connect the terminals of the capacitor to the pins of the converter. An RC network can also be used to filter the reference voltage. A 100- $\Omega$  series resistor and a 0.1- $\mu$ F capacitor, which can also serve as the decoupling capacitor can be used to filter the reference voltage.

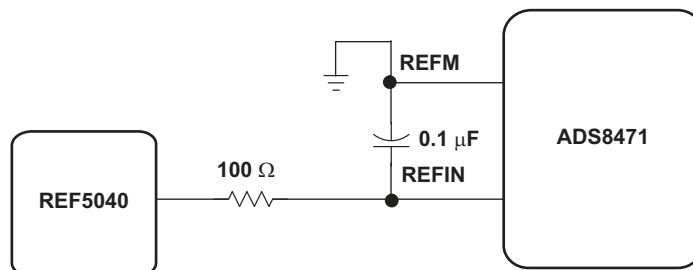

Figure 38. ADS8471 Using External Reference

The ADS8471 also has limited low pass filtering capability built into the converter. The equivalent circuitry on the REFIN input is as shown in [Figure 39](#).

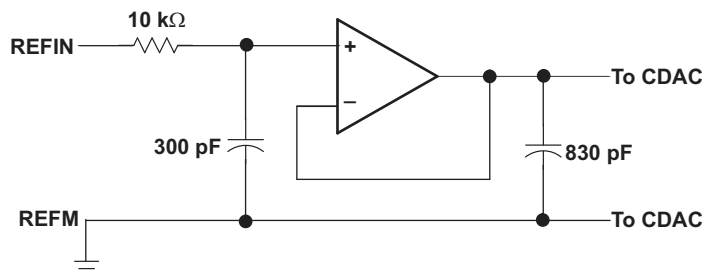

Figure 39. Reference Circuit

The REFM input of the ADS8471 should always be shorted to AGND.

A 4.096-V internal reference is included. When internal reference is used, pin 14 (REFOUT) is connected to pin 13 (REFIN) with a 0.1- $\mu$ F decoupling capacitor and 1- $\mu$ F storage capacitor between pin 14 (REFOUT) and pins 11 and 12 (REFM) (see [Figure 37](#)). The internal reference of the converter is double buffered. If an external reference is used, the second buffer provides isolation between the external reference and the CDAC. This buffer is also used to recharge all of the capacitors of the CDAC during conversion. Pin 14 (REFOUT) can be left unconnected (floating) if an external reference is used.

## ANALOG INPUT

When the converter enters the hold mode, the voltage difference between the +IN and –IN inputs is captured on the internal capacitor array. The voltage on the –IN input is limited between  $-0.2\text{ V}$  and  $0.2\text{ V}$ , allowing the input to reject small signals which are common to both the +IN and –IN inputs. The +IN input has a range of  $-0.2\text{ V}$  to  $V_{\text{ref}} + 0.2\text{ V}$ . The input span [+IN – (–IN)] is limited to  $0\text{ V}$  to  $V_{\text{ref}}$ .

The input current on the analog inputs depends upon a number of factors: sample rate, input voltage, and source impedance. Essentially, the current into the ADS8471 charges the internal capacitor array during the sample period. After this capacitance has been fully charged, there is no further input current. The source of the analog input voltage must be able to charge the input capacitance ( $65\text{ pF}$ ) to an 16-bit settling level within the acquisition time ( $270\text{ ns}$ ) of the device. When the converter goes into the hold mode, the input impedance is greater than  $1\text{ G}\Omega$ .

Care must be taken regarding the absolute analog input voltage. To maintain the linearity of the converter, the +IN and –IN inputs and the span [+IN – (–IN)] must be within the limits specified. Outside of these ranges, the converter's linearity may not meet specifications. To minimize noise, low bandwidth input signals with low-pass filters are used.

Care must be taken to ensure that the output impedance of the sources driving the +IN and –IN inputs are matched. If this is not observed, the two inputs could have different settling times. This may result in offset error, gain error, and linearity error which varies with temperature and input voltage.

The analog input to the converter needs to be driven with a low noise, high-speed op-amp like the THS4031. An RC filter is recommended at the input pins to low-pass filter the noise from the source. A series resistor of  $20\text{ }\Omega$  and a decoupling capacitor of  $680\text{ pF}$  is recommended. The input to the converter is a uni-polar input voltage in the range  $0$  to  $V_{\text{ref}}$ . The THS4031 can be used in the source follower configuration to drive the converter (see [Figure 40](#)).

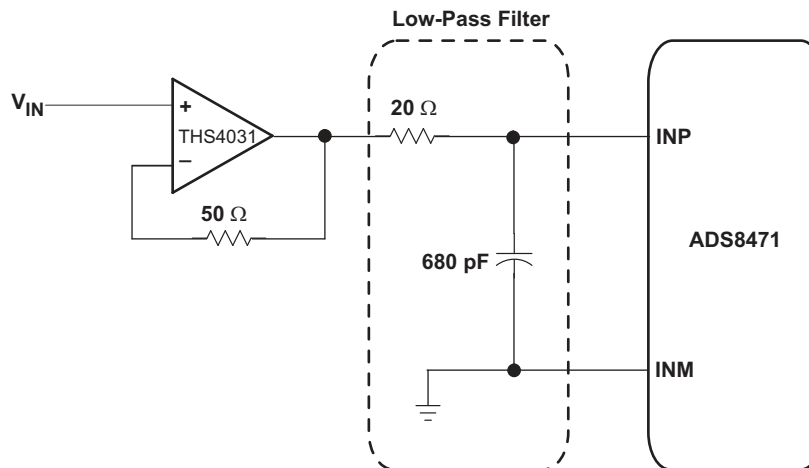

**Figure 40. Unipolar Input Driving Circuit**

In systems, where the input is bi-polar, the THS4031 can be used in the inverting configuration with an additional DC bias applied to its + input so as to keep the input to the ADS8471 within its rated operating voltage range (see [Figure 41](#)). This configuration is also recommended when the ADS8471 is used in signal processing applications where good SNR and THD performance is required. The DC bias can be derived from the REF3220 or the REF5040 reference voltage ICs. The input configuration shown below is capable of delivering better than 91dB SNR and -100db THD at an input frequency of  $100\text{ kHz}$ . In case band-pass filters are used to filter the input, care should be taken to ensure that the signal swing at the input of the band-pass filter is small so as to keep the distortion introduced by the filter minimal. In such cases, the gain of the circuit shown below can be increased to keep the input to the ADS8471 large to keep the SNR of the system high. Note that the gain of the system from the + input to the output of the THS4031 in such a configuration is a function of the gain of the AC signal. A resistor divider can be used to scale the output of the REF3220 or REF5040 to reduce the voltage at the DC input to THS4031 to keep the voltage at the input of the converter within its rated operating range.

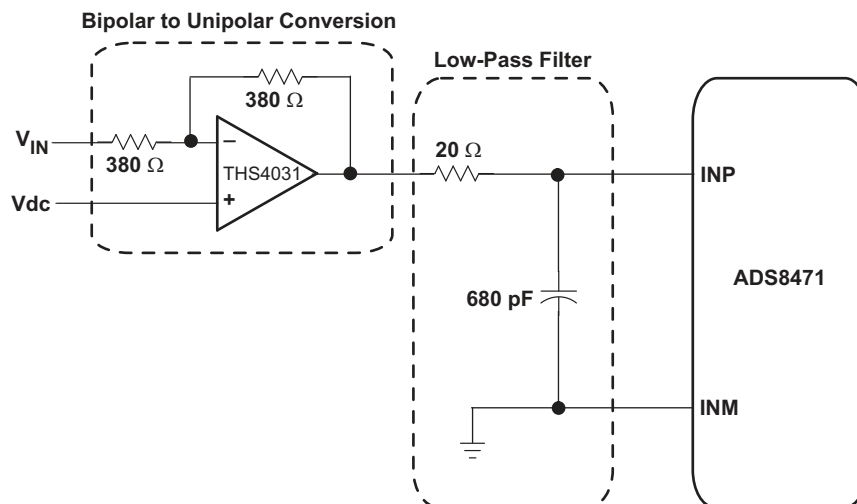

**Figure 41. Bipolar Input Driving Circuit**

## DIGITAL INTERFACE

### Timing and Control

See the timing diagrams in the specifications section for detailed information on timing signals and their requirements.

The ADS8471 uses an internal oscillator generated clock which controls the conversion rate and in turn the throughput of the converter. No external clock input is required.

Conversions are initiated by bringing the  $\overline{\text{CONVST}}$  pin low for a minimum of 20 ns (after the 20 ns minimum requirement has been met, the  $\overline{\text{CONVST}}$  pin can be brought high), while  $\overline{\text{CS}}$  is low. The ADS8471 switches from the sample to the hold mode on the falling edge of the  $\overline{\text{CONVST}}$  command. A clean and low jitter falling edge of this signal is important to the performance of the converter. The  $\overline{\text{BUSY}}$  output is brought high immediately following  $\overline{\text{CONVST}}$  going low.  $\overline{\text{BUSY}}$  stays high throughout the conversion process and returns low when the conversion has ended.

Sampling starts with the falling edge of the  $\overline{\text{BUSY}}$  signal when  $\overline{\text{CS}}$  is tied low or starts with the falling edge of  $\overline{\text{CS}}$  when  $\overline{\text{BUSY}}$  is low.

Both  $\overline{\text{RD}}$  and  $\overline{\text{CS}}$  can be high during and before a conversion with one exception ( $\overline{\text{CS}}$  must be low when  $\overline{\text{CONVST}}$  goes low to initiate a conversion). Both the  $\overline{\text{RD}}$  and  $\overline{\text{CS}}$  pins are brought low in order to enable the parallel output bus with the conversion.

### Reading Data

The ADS8471 outputs full parallel data in straight binary format as shown in [Table 1](#). The parallel output is active when  $\overline{\text{CS}}$  and  $\overline{\text{RD}}$  are both low. There is a minimal quiet zone requirement around the falling edge of  $\overline{\text{CONVST}}$ . This is 50 ns prior to the falling edge of  $\overline{\text{CONVST}}$  and 40 ns after the falling edge. No data read should be attempted within this zone. Any other combination of  $\overline{\text{CS}}$  and  $\overline{\text{RD}}$  sets the parallel output to 3-state.  $\overline{\text{BYTE}}$  is used for multiword read operations.  $\overline{\text{BYTE}}$  is used whenever lower bits on the bus are output on the higher byte of the bus. Refer to [Table 1](#) for ideal output codes.

**Table 1. Ideal Input Voltages and Output Codes**

DESCRIPTION	ANALOG VALUE	DIGITAL OUTPUT STRAIGHT BINARY	
		BINARY CODE	HEX CODE
Full scale range	$+V_{ref}$		
Least significant bit (LSB)	$+V_{ref}/65536$		
+Full scale	$(+V_{ref}) - 1 \text{ LSB}$	1111 1111 1111 1111	FFFF
Midscale	$+V_{ref}/2$	1000 0000 0000 0000	8000
Midscale – 1 LSB	$+V_{ref}/2 - 1 \text{ LSB}$	0111 1111 1111 1111	7FFF
Zero	0 V	0000 0000 0000 0000	0000

The output data is a full 16-bit word (D15–D0) on DB15–DB0 pins (MSB–LSB) if BYTE is low.

The result may also be read on an 8-bit bus for convenience. This is done by using only pins DB15–DB8. In this case two reads are necessary: the first as before, leaving BYTE low and reading the 8 most significant bits on pins DB15–DB8, then bringing BYTE high. When BYTE is high, the low bits (D7–D0) appear on pins DB15–DB8.

All of these multiword read operations can be performed with multiple active  $\overline{RD}$  (toggling) or with  $\overline{RD}$  held low for simplicity. This is referred to as the AUTO READ operation.

**Table 2. Conversion Data Read Out**

BYTE	DATA READ OUT	
	PINS DB15–DB8	PINS DB7–DB0
High	D7-D0	All One's
Low	D15-D8	D7–D0

## RESET

On power-up, internal POWER-ON RESET circuitry generates the reset required for the device. The first three conversions after power-up are used to load factory trimming data for a specific device to assure high accuracy of the converter. The results of the first three conversions are invalid and should be discarded.

The device can also be reset through the use of the combination of  $\overline{CS}$  and  $\overline{CONVST}$ . Since the BUSY signal is held at high during the conversion, either one of these conditions triggers an internal self-clear reset to the converter.

- Issue a  $\overline{CONVST}$  when  $\overline{CS}$  is low and the internal convert state is high. The falling edge of  $\overline{CONVST}$  starts a reset.
- Issue a  $\overline{CS}$  (select the device) while the internal convert state is high. The falling edge of  $\overline{CS}$  causes a reset.

Once the device is reset, all output latches are cleared (set to zeroes) and the BUSY signal is brought low. A new sampling period is started at the falling edge of the BUSY signal immediately after the instant of the internal reset.

## LAYOUT

For optimum performance, care must be taken with the physical layout of the ADS8471 circuitry.

As the ADS8471 offers single-supply operation, it is often used in close proximity with digital logic, microcontrollers, microprocessors, and digital signal processors. The more digital logic present in the design and the higher the switching speed, the more difficult it is to achieve good performance from the converter.

The basic SAR architecture is sensitive to glitches or sudden changes on the power supply, reference, ground connections and digital inputs that occur just prior to latching the output of the analog comparator. Thus, driving any single conversion for an n-bit SAR converter, there are at least n windows in which large external transient voltages can affect the conversion result. Such glitches might originate from switching power supplies, nearby digital logic, or high power devices.

The degree of error in the digital output depends on the reference voltage, layout, and the exact timing of the external event.

On average, the ADS8471 draws very little current from an external reference as the reference voltage is internally buffered. If the reference voltage is external and originates from an op amp, make sure that it can drive the bypass capacitor or capacitors without oscillation. A 0.1- $\mu$ F capacitor is recommended from pin 13 (REFIN) directly to pin 12 (REFM). REFM and AGND must be shorted on the same ground plane under the device.



The AGND and BDGND pins should be connected to a clean ground point. In all cases, this should be the analog ground. Avoid connections which are too close to the grounding point of a microcontroller or digital signal processor. If required, run a ground trace directly from the converter to the power supply entry point. The ideal layout consists of an analog ground plane dedicated to the converter and associated analog circuitry.

As with the AGND connections, +VA should be connected to a 5-V power supply plane or trace that is separate from the connection for digital logic until they are connected at the power entry point. Power to the ADS8471 should be clean and well bypassed. A 0.1- $\mu$ F ceramic bypass capacitor should be placed as close to the device as possible. See [Table 3](#) for the placement of the capacitor. In addition, a 1- $\mu$ F to 10- $\mu$ F capacitor is recommended. In some situations, additional bypassing may be required, such as a 100- $\mu$ F electrolytic capacitor or even a Pi filter made up of inductors and capacitors—all designed to essentially low-pass filter the 5-V supply, removing the high frequency noise.

**Table 3. Power Supply Decoupling Capacitor Placement**

POWER SUPPLY PLANE	CONVERTER ANALOG SIDE	CONVERTER DIGITAL SIDE
SUPPLY PINS		
Pin pairs that require shortest path to decoupling capacitors	(7,8), (9,10), (16,17), (20,21), (22,23), (25,26)	36, 37
Pins that require no decoupling	24, 26	1,2

**PACKAGING INFORMATION**

Orderable Device	Status (1)	Package Type	Package Drawing	Pins	Package Qty	Eco Plan (2)	Lead finish/ Ball material (6)	MSL Peak Temp (3)	Op Temp (°C)	Device Marking (4/5)	Samples
ADS84711BRGZT	ACTIVE	VQFN	RGZ	48	250	RoHS & Green	Call TI	Level-2-260C-1 YEAR	-40 to 85	ADS 84711 B	
ADS84711RGZT	ACTIVE	VQFN	RGZ	48	250	RoHS & Green	Call TI	Level-2-260C-1 YEAR	-40 to 85	ADS 84711	

(1) The marketing status values are defined as follows:

**ACTIVE:** Product device recommended for new designs.

**LIFEBUY:** TI has announced that the device will be discontinued, and a lifetime-buy period is in effect.

**NRND:** Not recommended for new designs. Device is in production to support existing customers, but TI does not recommend using this part in a new design.

**PREVIEW:** Device has been announced but is not in production. Samples may or may not be available.

**OBSELETE:** TI has discontinued the production of the device.

(2) **RoHS:** TI defines "RoHS" to mean semiconductor products that are compliant with the current EU RoHS requirements for all 10 RoHS substances, including the requirement that RoHS substance do not exceed 0.1% by weight in homogeneous materials. Where designed to be soldered at high temperatures, "RoHS" products are suitable for use in specified lead-free processes. TI may reference these types of products as "Pb-Free".

**RoHS Exempt:** TI defines "RoHS Exempt" to mean products that contain lead but are compliant with EU RoHS pursuant to a specific EU RoHS exemption.

**Green:** TI defines "Green" to mean the content of Chlorine (Cl) and Bromine (Br) based flame retardants meet JS709B low halogen requirements of <=1000ppm threshold. Antimony trioxide based flame retardants must also meet the <=1000ppm threshold requirement.

(3) MSL, Peak Temp. - The Moisture Sensitivity Level rating according to the JEDEC industry standard classifications, and peak solder temperature.

(4) There may be additional marking, which relates to the logo, the lot trace code information, or the environmental category on the device.

(5) Multiple Device Markings will be inside parentheses. Only one Device Marking contained in parentheses and separated by a "~" will appear on a device. If a line is indented then it is a continuation of the previous line and the two combined represent the entire Device Marking for that device.

(6) Lead finish/Ball material - Orderable Devices may have multiple material finish options. Finish options are separated by a vertical ruled line. Lead finish/Ball material values may wrap to two lines if the finish value exceeds the maximum column width.

**Important Information and Disclaimer:**The information provided on this page represents TI's knowledge and belief as of the date that it is provided. TI bases its knowledge and belief on information provided by third parties, and makes no representation or warranty as to the accuracy of such information. Efforts are underway to better integrate information from third parties. TI has taken and continues to take reasonable steps to provide representative and accurate information but may not have conducted destructive testing or chemical analysis on incoming materials and chemicals. TI and TI suppliers consider certain information to be proprietary, and thus CAS numbers and other limited information may not be available for release.



In no event shall TI's liability arising out of such information exceed the total purchase price of the TI part(s) at issue in this document sold by TI to Customer on an annual basis.

## GENERIC PACKAGE VIEW

**RGZ 48**

**VQFN - 1 mm max height**

7 x 7, 0.5 mm pitch

PLASTIC QUADFLAT PACK- NO LEAD

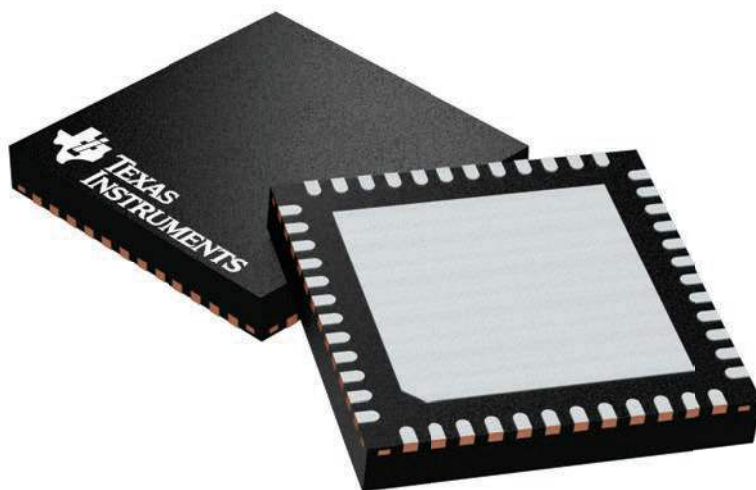

Images above are just a representation of the package family, actual package may vary.  
Refer to the product data sheet for package details.

4224671/A

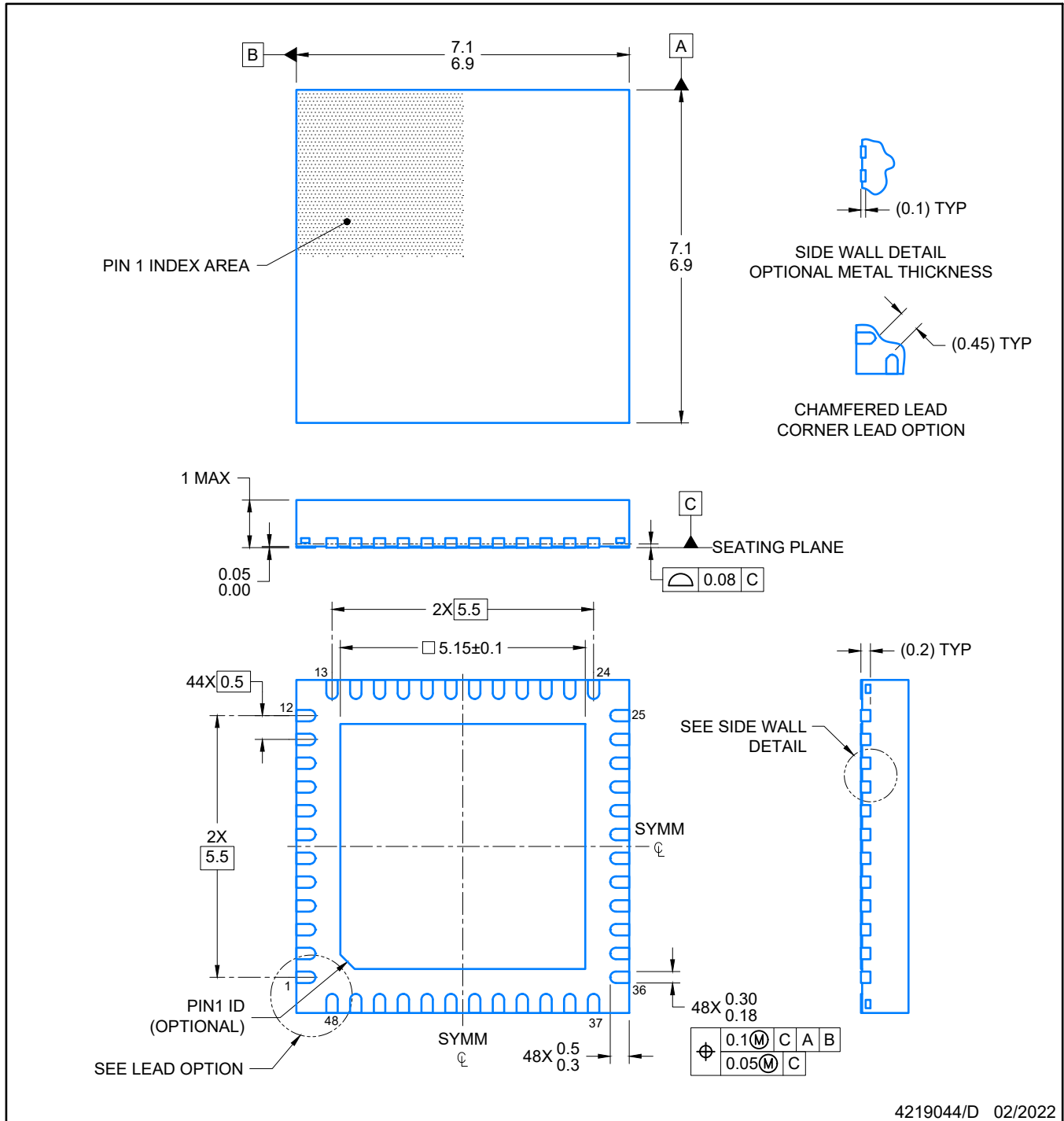

4219044/D 02/2022

NOTES:

1. All linear dimensions are in millimeters. Any dimensions in parenthesis are for reference only. Dimensioning and tolerancing per ASME Y14.5M.
2. This drawing is subject to change without notice.
3. The package thermal pad must be soldered to the printed circuit board for optimal thermal and mechanical performance.

# EXAMPLE BOARD LAYOUT

RGZ0048A

VQFN - 1 mm max height

PLASTIC QUADFLAT PACK- NO LEAD

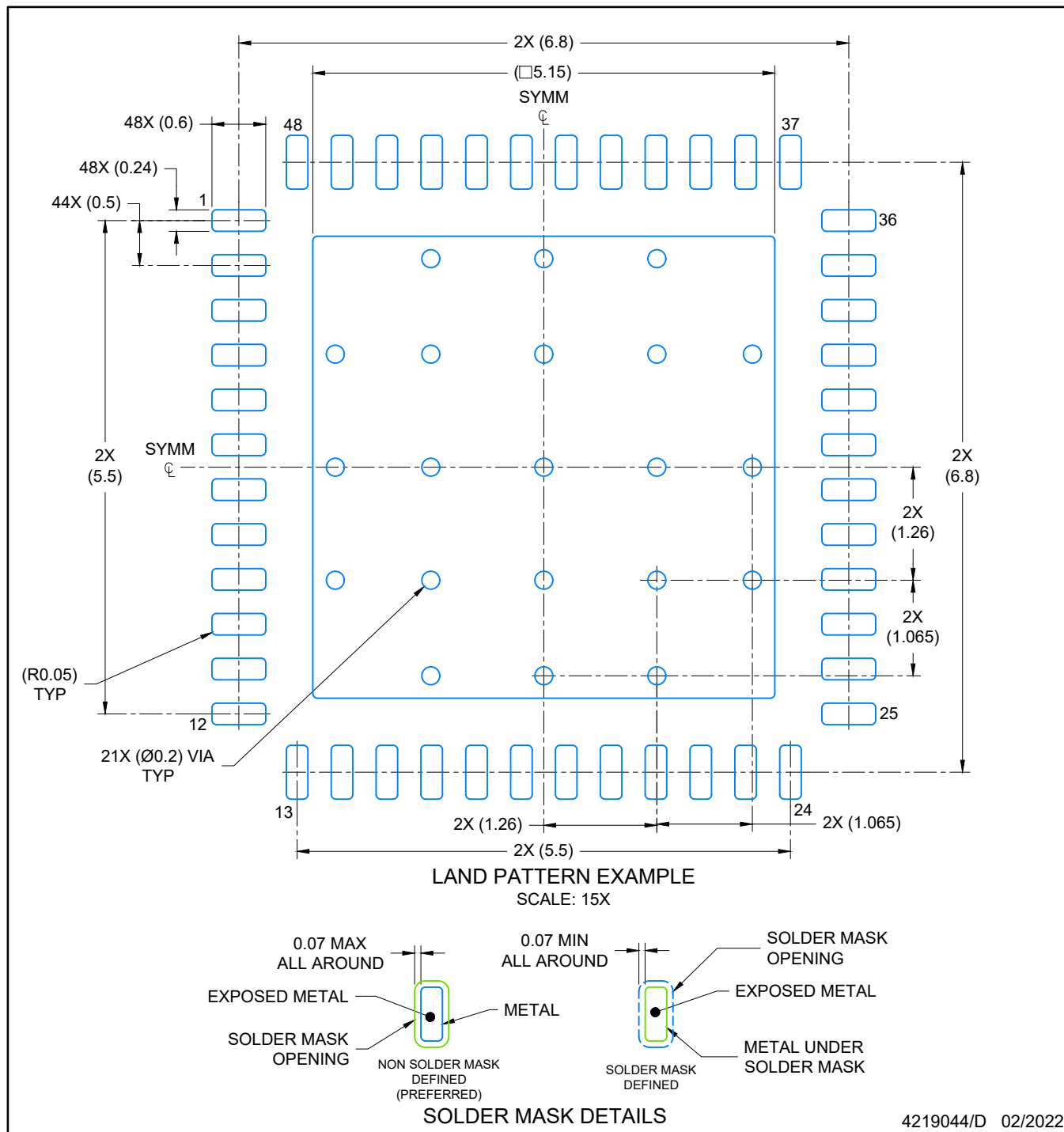

NOTES: (continued)

4. This package is designed to be soldered to a thermal pad on the board. For more information, see Texas Instruments literature number SLUA271 ([www.ti.com/lit/slua271](http://www.ti.com/lit/slua271)).
5. Vias are optional depending on application, refer to device data sheet. If any vias are implemented, refer to their locations shown on this view. It is recommended that vias under paste be filled, plugged or tented.

# EXAMPLE STENCIL DESIGN

RGZ0048A

VQFN - 1 mm max height

PLASTIC QUADFLAT PACK- NO LEAD

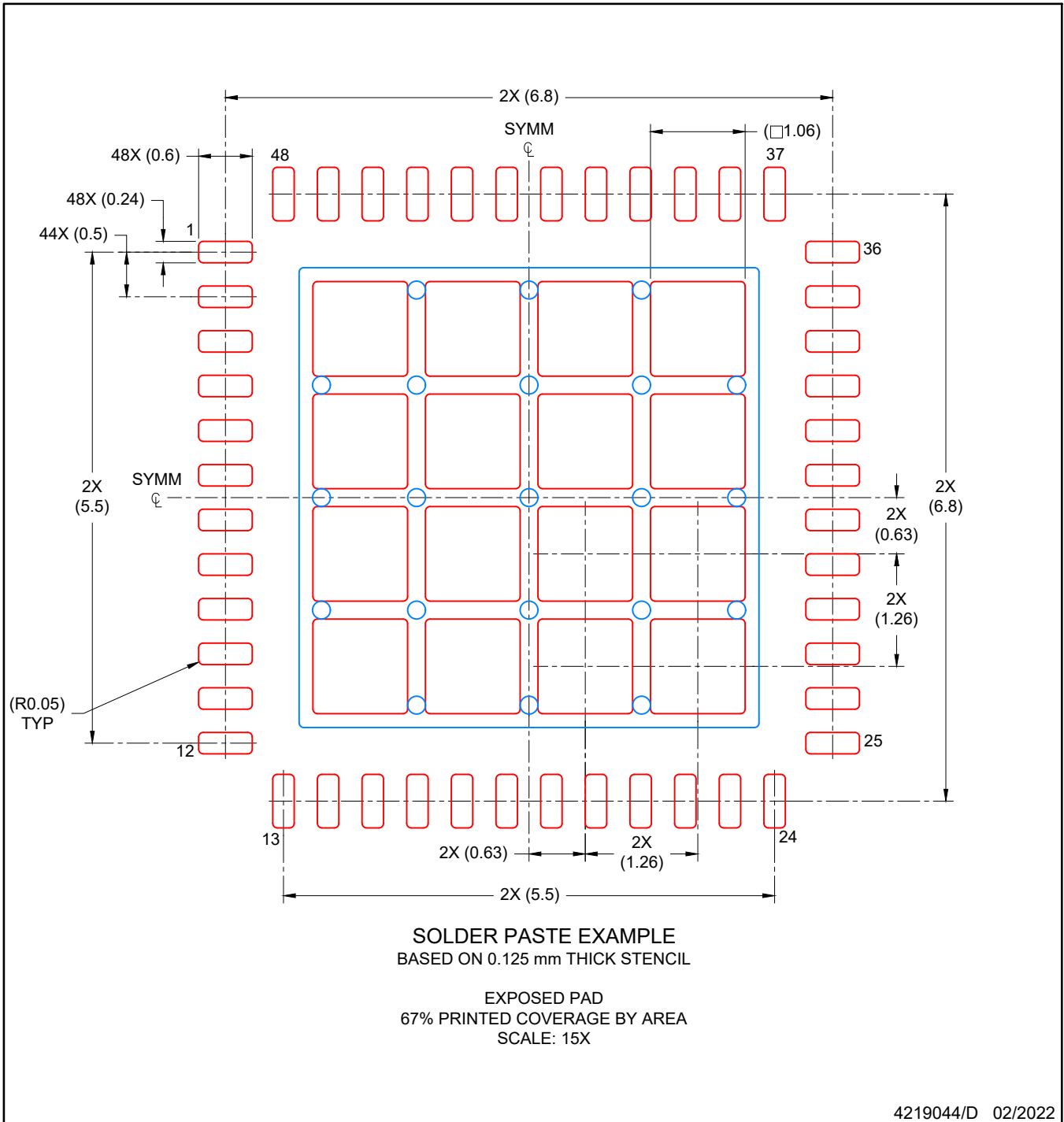

NOTES: (continued)

6. Laser cutting apertures with trapezoidal walls and rounded corners may offer better paste release. IPC-7525 may have alternate design recommendations.

## IMPORTANT NOTICE AND DISCLAIMER

TI PROVIDES TECHNICAL AND RELIABILITY DATA (INCLUDING DATA SHEETS), DESIGN RESOURCES (INCLUDING REFERENCE DESIGNS), APPLICATION OR OTHER DESIGN ADVICE, WEB TOOLS, SAFETY INFORMATION, AND OTHER RESOURCES "AS IS" AND WITH ALL FAULTS, AND DISCLAIMS ALL WARRANTIES, EXPRESS AND IMPLIED, INCLUDING WITHOUT LIMITATION ANY IMPLIED WARRANTIES OF MERCHANTABILITY, FITNESS FOR A PARTICULAR PURPOSE OR NON-INFRINGEMENT OF THIRD PARTY INTELLECTUAL PROPERTY RIGHTS.

These resources are intended for skilled developers designing with TI products. You are solely responsible for (1) selecting the appropriate TI products for your application, (2) designing, validating and testing your application, and (3) ensuring your application meets applicable standards, and any other safety, security, regulatory or other requirements.

These resources are subject to change without notice. TI grants you permission to use these resources only for development of an application that uses the TI products described in the resource. Other reproduction and display of these resources is prohibited. No license is granted to any other TI intellectual property right or to any third party intellectual property right. TI disclaims responsibility for, and you will fully indemnify TI and its representatives against, any claims, damages, costs, losses, and liabilities arising out of your use of these resources.

TI's products are provided subject to [TI's Terms of Sale](#) or other applicable terms available either on [ti.com](http://ti.com) or provided in conjunction with such TI products. TI's provision of these resources does not expand or otherwise alter TI's applicable warranties or warranty disclaimers for TI products.

TI objects to and rejects any additional or different terms you may have proposed.

Mailing Address: Texas Instruments, Post Office Box 655303, Dallas, Texas 75265  
Copyright © 2022, Texas Instruments Incorporated