

CSG series

Switch guards for switch series 5000M - 600H



DISTINCTIVE FEATURES

Modern, patented design

Lightweight

Anti-tamper wire seal hole as standard



GENERAL SPECIFICATIONS

- APEM SAS patented design
- Operating temperature : -20 °C to +55 °C (-4 °F to +131 °F)
- Storage temperature : -40 °C to +85 °C (-40 °F to +185 °F)
- Switch guards are designed to prevent accidental lever operation on switches with \varnothing 11.9 (.468) or \varnothing 12 (.472) threaded bushing and lever length 17.5 (.688) outside bushing.
When the guard is raised, the lever can be operated freely.
When the guard is fully depressed, the lever is locked in a stable position.
Please note that these guards are not intended to reset the actuator in the desired position.
For correct switch operation, the switch guard should be adjusted properly (see "Mounting" below).



MATERIALS

- Support plate : thermoplastic
- Cap : thermoplastic



MOUNTING

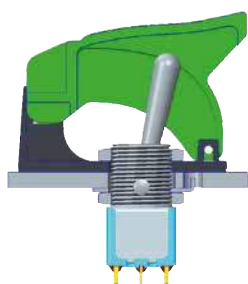

Standard



With K sealing option

The company reserves the right to change specifications without notice.



PANEL CUT-OUT

FOR BUSHING WITH KEYWAY

K



CSG series

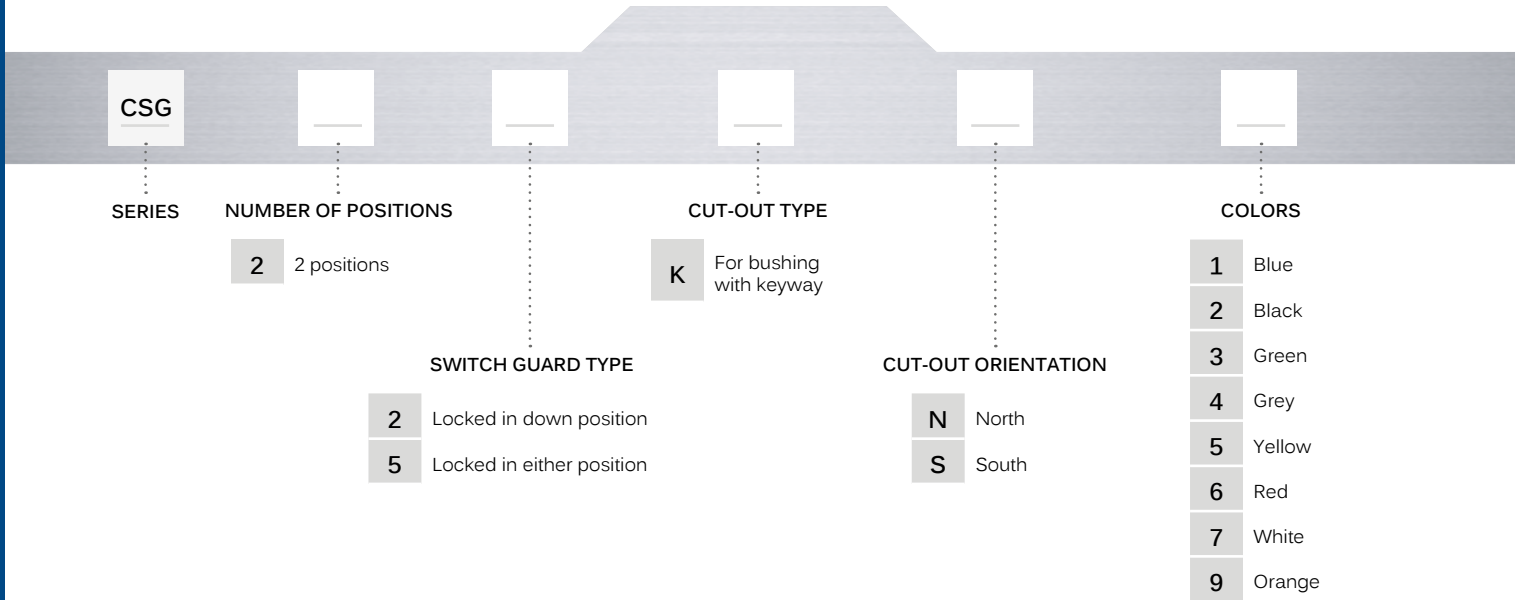

Switch guards for switch series 5000M - 600H

BUILD YOUR PART NUMBER



ABOUT THIS SERIES

On the following pages, you will find successively basic part numbers and options in the same order as in above chart.

-  **Notice :** please note that not all combinations of above numbers are available. Refer to the following pages for further information.
-  **Mounting accessories :** supplied with the switch or to order separately (see "Hardware" section of website).

DIMENSIONS



Note : Ø 1.60 mm holes for wiring a seal are standard on all models.

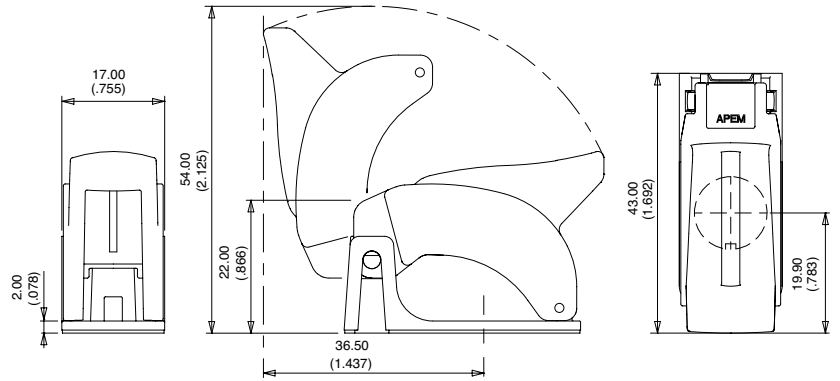

NUMBER OF POSITIONS



2 2 positions

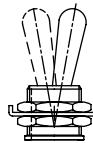

SWITCH GUARD TYPE



2 Locked in down position
5 Locked in either position

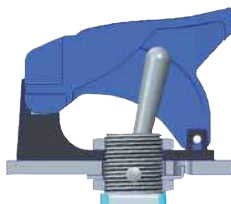

2

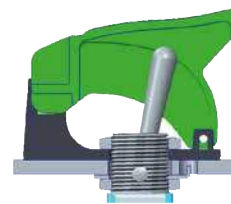

5

CUT-OUT ORIENTATION

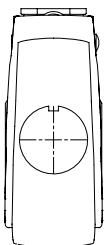

N

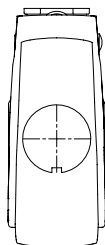

S

CSG series

Switch guards for switch series 5000M - 600H

COLORS

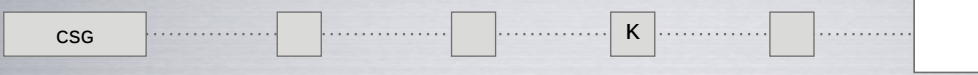

- 1 Blue
- 2 Black
- 3 Green
- 4 Grey
- 5 Yellow
- 6 Red
- 7 White
- 9 Orange

