



Main

Range of Product	Telemecanique Photoelectric sensors XU
Series name	General purpose multimode
Electronic sensor type	Photo-electric sensor
Sensor name	XUX
Sensor design	Compact 92 x 71
Detection system	Multimode
Material	Plastic
Type of output signal	Discrete
Supply circuit type	DC
Wiring Technique	3-wire
Discrete output function	1 NO or 1 NC programmable
Electrical connection	Screw-clamp terminals, 1 x 1.5 mm ² or 1 x 0.75 mm ² with adaptor
Product Specific Application	-
Emission	Infrared diffuse Infrared diffuse with background suppression Infrared thru beam Red polarised reflex
[Sn] nominal sensing distance	36.09 Ft (11 m) polarised reflex need reflector XUZC50 131.23 Ft (40 m) thru beam need a transmitter XUX0AKSAT16T 6.56 Ft (2 m) diffuse 4.27 ft (1.3 m) diffuse with background suppression

Complementary

Enclosure Material	PBT
Lens material	PMMA
Maximum sensing distance	49.21 Ft (15 m) polarised reflex 9.84 Ft (3 m) diffuse 196.85 Ft (60 m) thru beam 4.27 ft (1.3 m) diffuse with background suppression
Output Type	Solid state
Add on output	With alarm output, <= 100 mA overload and short-circuit protection
Cable entry	1 entry for M16 x 1.5 cable gland 0.28...0.39 in (7...10 mm)
Status LED	1 LED green)supply 1 LED red)instability 1 LED yellow)output state
[Us] rated supply voltage	12...24 V DC reverse polarity protection
Switching capacity in mA	<= 100 mA overload and short-circuit protection)
Switching frequency	<= 250 Hz
Maximum voltage drop	<1.5 V closed state)
Current consumption	<= 35 mA no-load
Maximum delay first up	200 ms
Maximum delay response	2 ms
Maximum delay recovery	2 ms
Setting-up	Self-teaching
Depth	3.03 in (77 mm)
Height	3.62 in (92 mm)

Width	1.22 in (31 mm)
Net Weight	0.44 lb(US) (0.2 kg)

Environment

Product Certifications	UL CSA CE
Ambient air temperature for operation	-13...131 °F (-25...55 °C)
Ambient Air Temperature for Storage	-40...158 °F (-40...70 °C)
Vibration resistance	7 gn +/- 1.5 mm 10...55 Hz) IEC 60068-2-6
Shock resistance	30 gn 11 ms) IEC 60068-2-27
IP degree of protection	IP65 double insulation IEC 60529 IP67 double insulation IEC 60529

Ordering and shipping details

Category	22481 - SENSORS, PHOTOELECTRIC
Discount Schedule	DS2
GTIN	3389110168044
Nbr. of units in pkg.	1
Package weight(Lbs)	6.88 oz (195 g)
Returnability	Yes
Country of origin	FR

Packing Units

Unit Type of Package 1	PCE
Package 1 Height	1.65 in (4.2 cm)
Package 1 width	3.74 in (9.5 cm)
Package 1 Length	5.12 in (13 cm)
Unit Type of Package 2	S02
Number of Units in Package 2	22
Package 2 Weight	10.45 lb(US) (4.741 kg)
Package 2 Height	5.91 in (15 cm)
Package 2 width	11.81 in (30 cm)
Package 2 Length	15.75 in (40 cm)

Offer Sustainability

Sustainable offer status	Green Premium product
California proposition 65	WARNING: This product can expose you to chemicals including: Diisononyl phthalate (DINP), which is known to the State of California to cause cancer, and Di-isodecyl phthalate (DIDP), which is known to the State of California to cause birth defects or other reproductive harm. For more information go to www.P65Warnings.ca.gov
REACH Regulation	REACH Declaration
EU RoHS Directive	Pro-active compliance (Product out of EU RoHS legal scope) EU RoHS Declaration
Mercury free	Yes
RoHS exemption information	Yes
Environmental Disclosure	Product Environmental Profile
Circularity Profile	End Of Life Information

Contractual warranty

Warranty	18 months
----------	-----------

Dimensions

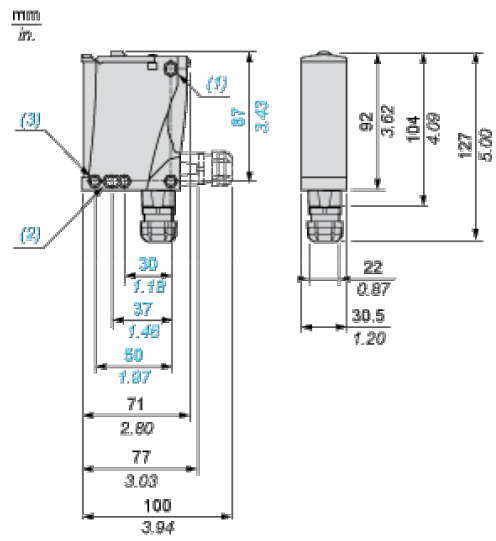

- (1) Elongated hole $\text{Ø } 5.5 \times 7$
- (2) Elongated hole $\text{Ø } 5.5 \times 9$
- (3) $\text{Ø } 5.5$ hole

Wiring Schemes

PNP/NPN DC

M12		Terminals		
1	●	1	⊘	+
3	●	2	⊘	-
4	●	3	⊘	Output
2	●	4	⊘	Alarm inactive

Detection Curves

With Thru-beam Accessory (Thru-beam)

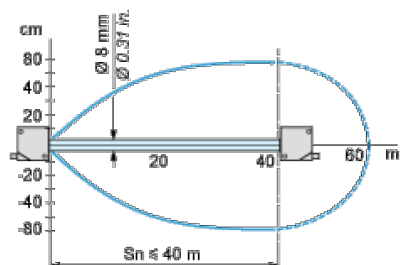

Without Accessory (Diffuse)

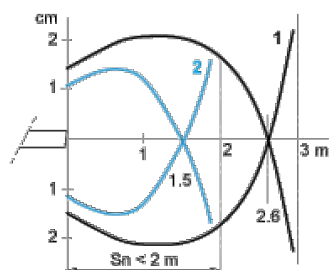

1 : White 90%
2 : Grey 18%
Object 10 x 10 cm

Without Accessory (Diffuse with background suppression)

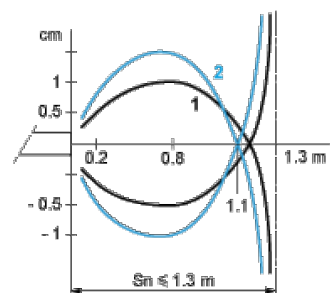

1 : White 90%
2 : Grey 18%
Object 10 x 10 cm

With reflector (Polarised reflex)

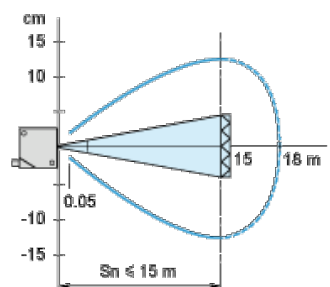

With reflector XUZC50

Variation of Usable Sensing Distance S_u (Without accessory, with adjustable background suppression)

Teach Mode at Minimum

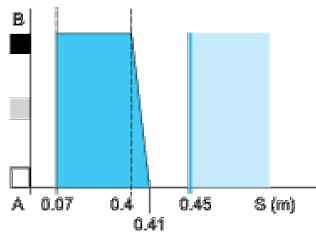

Teach Mode at Maximum

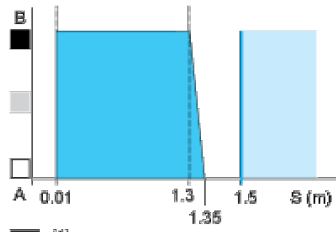

- (1) Black
- (2) Grey
- (3) White
- (4) Sensing range
- (5) Non sensing zone (matt surfaces)

A-B : Object reflection coefficient

- (1) Black 6%
- (2) Grey 18%
- (3) White 90%
- (4) Sensing range
- (5) Non sensing zone (matt surfaces)