

OSTAR - Projection

Lead (Pb) Free Product - RoHS Compliant

LE ATB A2A

Abkündigung nach OS-PD-2008-016
Obsolete acc. to OS-PD-2008-016

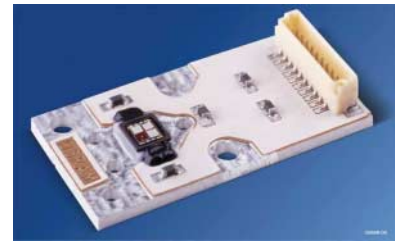

Besondere Merkmale

- **Gehäusertyp:** Kompakte Lichtquelle in Multi-Chip on Board Technologie; planvergossen
- **Besonderheit des Bauteils:** extrem hohe Helligkeit dank Oberflächenemission und niedrigem R_{th}
Vorbereitet für den Einsatz mit zus. Optik
- **Wellenlänge:** 617 nm (amber), 525 nm (true green), 464 nm (blau)
- **Abstrahlwinkel:** Lambertischer Strahler (120°)
- **Abstrahlende Fläche:** typ. 2.1 x 2.1 mm²
- **Technologie:** Thinfilm InGaAlP (amber), ThinGaN[®] (true green, blau)
- **Leuchtdichte:** 18*10⁶ cd/m² (amber), 14*10⁶ cd/m² (true green), 3,5*10⁶ cd/m² (blau)
- **max. optischer Wirkungsgrad:** 51 lm/W (amber), 86 lm/W (true green), 17 lm/W (blau) bei 100 mA mit Linse
- **Montierbarkeit:** verschraubbar
- **Stecker:** 10 Pin JST BM 10B-SRSS-TB
- **ESD-Festigkeit:** ESD-sicher bis 2 kV nach JESD22-A114-B
- **Verpackungseinheit:** 25 St. pro Box = Verpackungseinheit

Anwendungen

- Projektoren
- Medizintechnik: Operationslampen
- Mikroskopbeleuchtung
- Scheinwerfer
- Verkehrszeichen
- Hochwertige Blitzlichter

Features

- **package:** compact lightsource in multi chip on board technology planar sealed
- **feature of the device:** outstanding luminance due to pure surface emission and low R_{th}
prepared for additional optics
- **wavelength:** 617 nm (amber), 525 nm (true green), 464 nm (blue)
- **viewing angle:** Lambertian Emitter (120°)
- **light emitting surface:** typ. 2.1 x 2.1 mm²
- **technology:** Thinfilm InGaAlP (amber), ThinGaN[®] (true green, blue)
- **Luminance:** 18*10⁶ cd/m² (amber), 14*10⁶ cd/m² (true green), 3.5*10⁶ cd/m² (blue)
- **max. optical efficiency:** 51 lm/W (amber), 86 lm/W (true green), 17 lm/W (blue) at 100 mA with lens
- **mounting methode:** screw holes
- **connector:** 10 Pin JST BM 10B-SRSS-TB
- **ESD-withstand voltage:** up to 2 kV acc. to JESD22-A114-B
- **method of packing:** 25 pcs. per tray = packing unit

Applications

- projectors
- medical lighting: surgery light
- microscope illumination
- spotlights
- VMS (variable message signs)
- high end strobe light

Bestellinformation
Ordering Information

Typ Type	Emissionsfarbe Color of Emission	Lichstärke pro Farbe ¹⁾ Seite 17 Luminous Intensity per Color ¹⁾ page 17 $I_F = 750 \text{ mA (A) / 500 \text{ mA (T, B)}}$ $I_V \text{ (cd)}$					
		amber		true green		blue	
		min.	typ.	min.	typ.	min.	typ.
LE ATB A2A	amber true green (2 Chips) blue	12	18	23	28	2	3.5

Typ Type	Emissionsfarbe Color of Emission	Lichtfluss pro Farbe ²⁾³⁾ Seite 17 Luminous Flux per Color ²⁾³⁾ page 17 $I_F = 750 \text{ mA (A) / 500 \text{ mA (T, B)}}$ $\Phi_V \text{ (lm)}$					
		amber		true green		blue	
		min.	typ.	min.	typ.	min.	typ.
LE ATB A2A	amber true green (2 Chips) blue	(37)	(55)	(71)	(86)	(6)	(10.5)

Bestellinformation
Ordering Information

Typ Type	Bestellnummer Ordering Code
■ LE ATB A2A	Q65110A3646

- Abgekündigt nach OS-PD-2008-016 - wird durch LE ATB S2W ersetzt werden.
 Obsolete acc. to OS-PD-2008-016 - will be replaced by LE ATB S2W.
 Letzte Bestellung / Last Order: 2009-06-30
 Letzte Lieferung / Last Delivery: 2009-12-31

Grenzwerte Maximum Ratings

Bezeichnung Parameter	Symbol Symbol	Werte Values			Einheit Unit
		amber	true green	blue	
Betriebstemperatur* Operating temperature range*	$T_{\text{board, op}}$	- 40 ... + 85			°C
Lagertemperatur Storage temperature range	$T_{\text{board, stg}}$	- 40 ... + 85			°C
Sperrschichttemperatur Junction temperature	T_j	125			°C
Durchlassstrom pro Chip DC Forward current per chip DC ($T_{\text{board}}=25^\circ\text{C}$)	I_F	750	700		mA
Stoßstrom pro Chip DC Surge current per chip DC $t \leq 10 \mu\text{s}$, $D = 0.1$; $T_A=25^\circ\text{C}$	I_{FM}	2000	2000	2000	mA
Sperrspannung pro Chip DC Reverse voltage per chip DC ($T_{\text{board}}=25^\circ\text{C}$)	V_R	0.5			V
Sperrstrom Reverse current $V_R = 0.5 \text{ V}$	I_R	10			mA
Leistungsaufnahme pro Farbe Power consumption per Color ($T_{\text{board}}=25^\circ\text{C}$)	P_{tot}	2.55	6.0	3.0	W

* Eine Betauung des Moduls muss vermieden werden.
Condensation on the module has to be avoided.

Kennwerte Characteristics

Bezeichnung Parameter	Symbol Symbol	Werte Values			Einheit Unit
		amber	true green	blue	
Wärmewiderstand des gesamten Moduls Thermal resistance of the module Sperrschicht / Bodenplatte Junction / base plate	$R_{\text{th JB}}$	5			K/W

Kennwerte
Characteristics
 $(T_{\text{board}} = 25\text{ °C})$

Bezeichnung Parameter	Symbol Symbol	Werte Values			Einheit Unit
		amber	true green	blau	
Wellenlänge des emittierten Lichtes (typ.) Wavelength at peak emission $I_F = 750\text{ mA (A) / 500 mA (T, B)}$	λ_{peak}	627	521	460	nm
Dominantwellenlänge ^{4) Seite 17} (min.) Dominant wavelength ^{4) page 17} (typ.) $I_F = 750\text{ mA (A) / 500 mA (T, B)}$ (max.)	λ_{dom} λ_{dom} λ_{dom}	613 617 625	517 525 534	458 464 469	nm nm nm
Spektrale Bandbreite bei 50 % $\Phi_{\text{rel max}}$ (typ.) Spectral bandwidth at 50 % $\Phi_{\text{rel max}}$ $I_F = 750\text{ mA (A) / 500 mA (T, B)}$	$\Delta\lambda$	20	44	24	nm
Abstrahlwinkel bei 50 % I_V (Vollwinkel) (typ.) Viewing angle at 50 % I_V	2φ	120	120	120	Grad deg.
Durchlassspannung ^{5) Seite 17} (min.) Forward voltage ^{5) page 17} (typ.) $I_F = 750\text{ mA (A) / 500 mA (T, B)}$ (max.)	V_F V_F V_F	2.1 2.9 3.4	2.9 3.5 4.0	2.9 3.5 4.0	V V V
Temperaturkoeffizient von λ_{peak} pro Chip (typ.) Temperature coefficient of λ_{peak} per chip $I_F = 750\text{ mA (A) / 500 mA (T, B); } -10\text{ °C} \leq T \leq 100\text{ °C}$	$TC_{\lambda_{\text{peak}}}$	0.14	0.05	0.05	nm/K
Temperaturkoeffizient von λ_{dom} pro Chip (typ.) Temperature coefficient of λ_{dom} per chip $I_F = 750\text{ mA (A) / 500 mA (T, B); } -10\text{ °C} \leq T \leq 100\text{ °C}$	$TC_{\lambda_{\text{dom}}}$	0.08	0.01	0.02	nm/K
Temperaturkoeffizient von V_F pro Chip (typ.) Temperature coefficient of V_F per chip $I_F = 750\text{ mA (A) / 500 mA (T, B); } -10\text{ °C} \leq T \leq 100\text{ °C}$	TC_V	- 2.5	- 4.0	- 4.0	mV/K
Optischer Wirkungsgrad ohne Linse (typ.) Optical efficiency without Lens $I_F = 750\text{ mA (A) / 500 mA (T, B)}$	η_{opt}	25	25	6	lm/W
max. Optischer Wirkungsgrad mit Linse ^{6) Seite 17} (typ.) max. Optical efficiency with Lens ^{6) page 17} $I_F = 100\text{ mA (R, T, B)}$	$\eta_{\text{opt max.}}$	51	86	17	lm/W
Abstrahlende Fläche (typ.) Radiating Surface	A_{Color}	1.0	2.0	1.0	mm ²
Leuchtdichte (typ.) Luminance $I_F = 750\text{ mA (A) / 500 mA (T, B)}$	L_V	$18 \cdot 10^6$	$14 \cdot 10^6$	$3.5 \cdot 10^6$	cd/m ²

SMD NTC Thermistors

SMD NTC Thermistors

R_{25} [Ω]	No. of R/T characteristics*	$B_{25/50}$ [K]	$B_{25/85}$ [K]	Resistance Tolerance $\Delta R_N/R_N$	B value Tolerance $\Delta B/B$
10k	EPCOS 8502	3940	3980	$\pm 5\%$	$\pm 3\%$

* for further information please visit www.epcos.com

$$R_T = R_N \cdot e^{B \cdot \left(\frac{1}{T} - \frac{1}{T_N} \right)}$$

R_T = NTC resistance in Ω at temperature T in K
 R_N = NTC resistance in Ω at rated temperature T_N in K ($T_N = 298$ K for test condition)
T, T_N = temperature in K
e = base of the natural logarithm (e = 2.71828)

B = B value, material specific constant of the NTC thermistor

$$B = B_{N/T} = \frac{T \cdot T_N}{T - T_N} \cdot \ln \frac{R_N}{R_T}$$

Typische Thermistor Kennlinie^{2) 7) Seite 17}
Typical Thermistor Graph^{2) 7) page 17}
 $I_F = f(V_F); T_{\text{board}} = 25^\circ\text{C}$

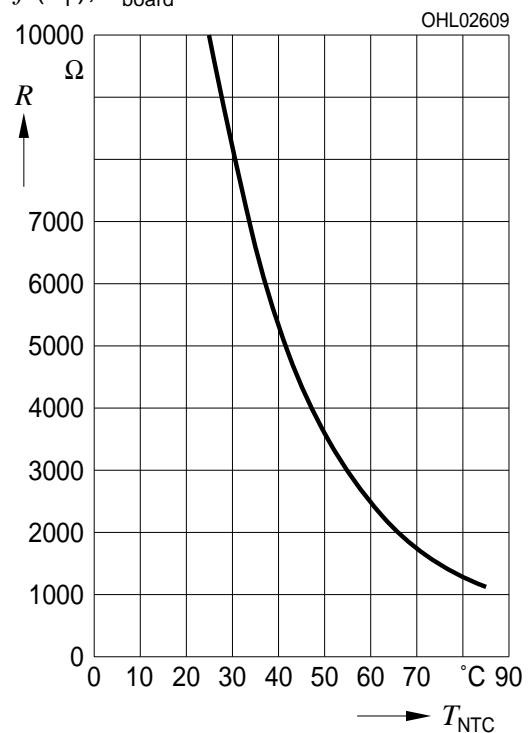

Relative spektrale Emission^{2) Seite 17}

Relative Spectral Emission^{2) page 17}

$V(\lambda)$ = spektrale Augenempfindlichkeit / Standard eye response curve

$\Phi_{rel} = f(\lambda)$, $T_{board} = 25\text{ °C}$, $I_F = 750\text{ mA (A) / 500\text{ mA (T, B)}$

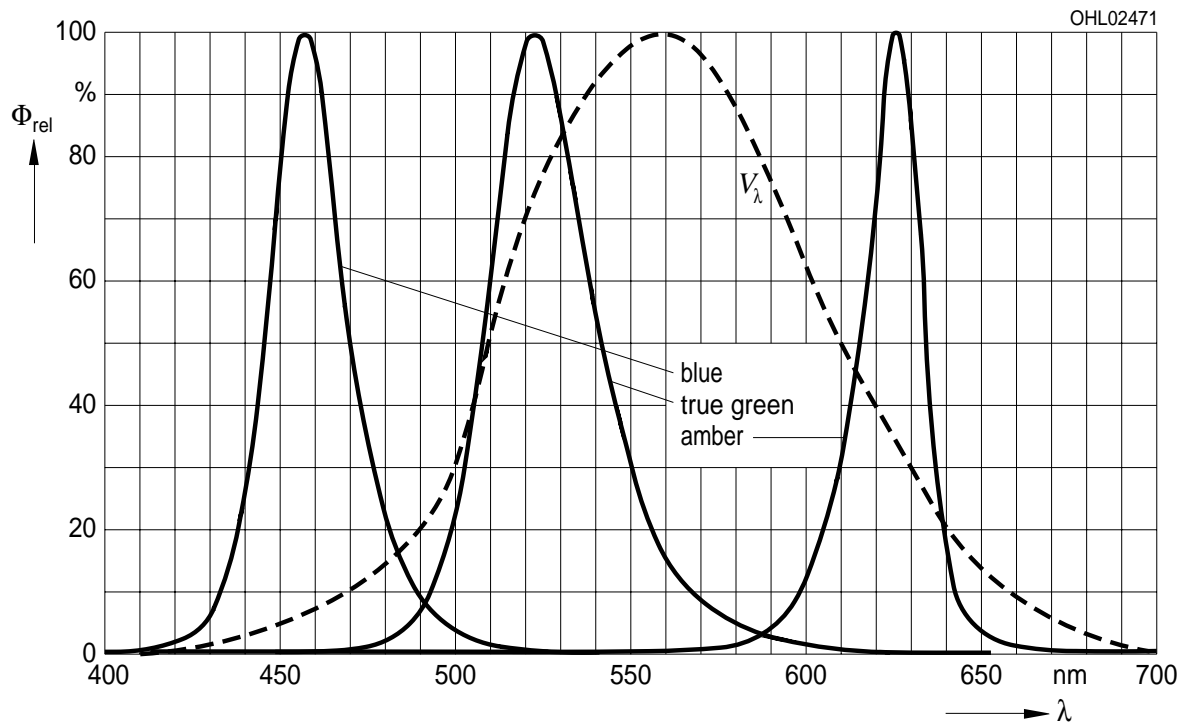

Abstrahlcharakteristik^{2) Seite 17}

Radiation Characteristic^{2) page 17}

$\Phi_{rel} = f(\varphi)$; $T_{board} = 25\text{ °C}$

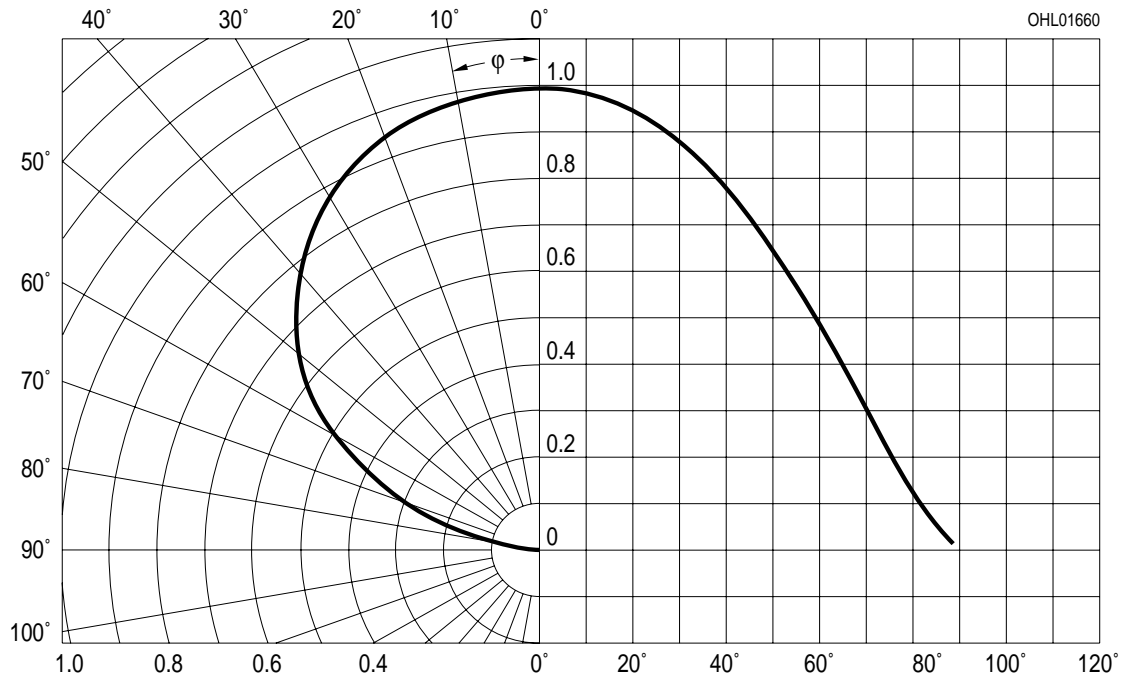

Durchlassstrom (amber)²⁾ Seite 17
Forward Current (amber)²⁾ page 17

$I_F = f(V_F); T_{board} = 25\text{ °C}$

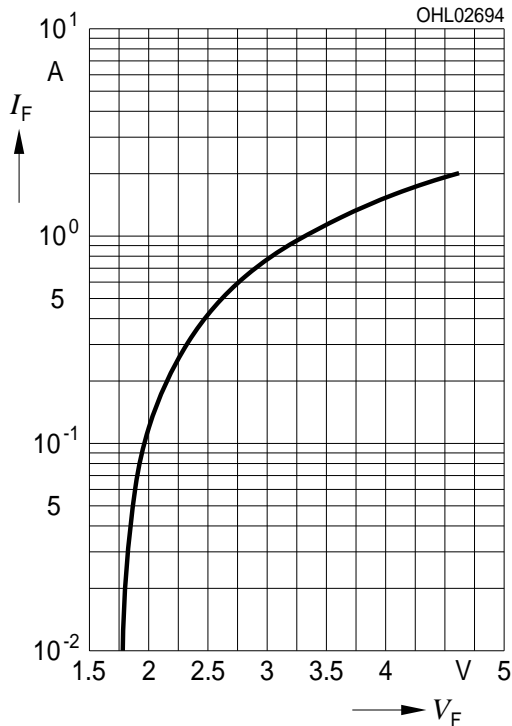

Relative Lichtstärke⁸⁾ Seite 17

Relative Luminous Intensity⁸⁾ page 17

$I_V/I_{V(750\text{ mA (A) / 500 mA (T, B)})} = f(I_F); T_{board} = 25\text{ °C}; t_p=1\text{ ms}, D=0,0003$

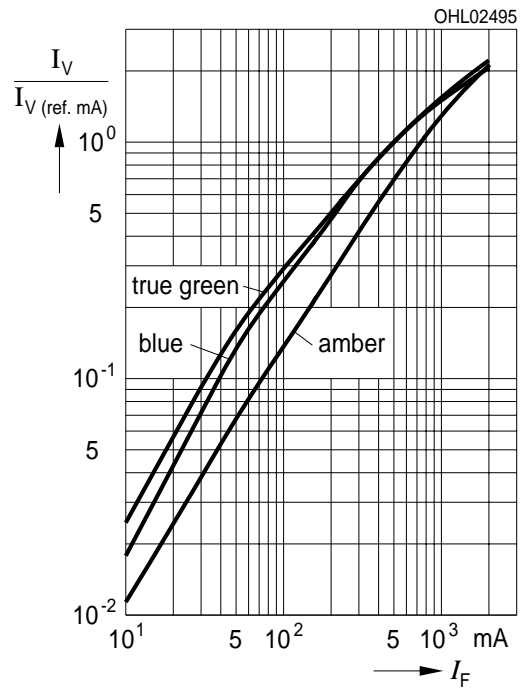

Durchlassstrom / (true green / blau)²⁾ Seite 17
Forward Current (true green / blue)²⁾ page 17

$I_F = f(V_F); T_{board} = 25\text{ °C}$

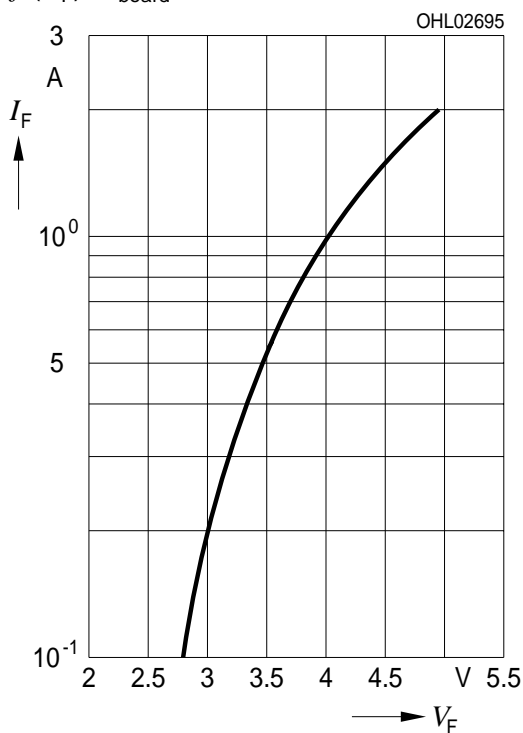

Relative Lichtstärke⁸⁾ Seite 17

Relative Luminous Intensity⁸⁾ page 17

$I_V/I_{V(25\text{ °C})} = f(T_j); I_F = 750\text{ mA (A) / 500 mA (T, B)}$

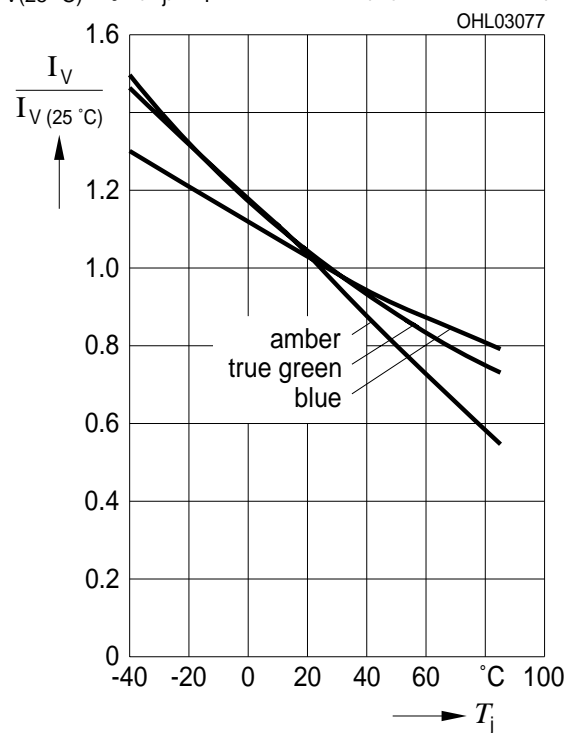

Dominante Wellenlänge²⁾ Seite 17

Dominant Wavelength²⁾ page 17

LA, $\lambda_{\text{dom}} = f(I_F)$; $T_{\text{board}} = 25\text{ °C}$

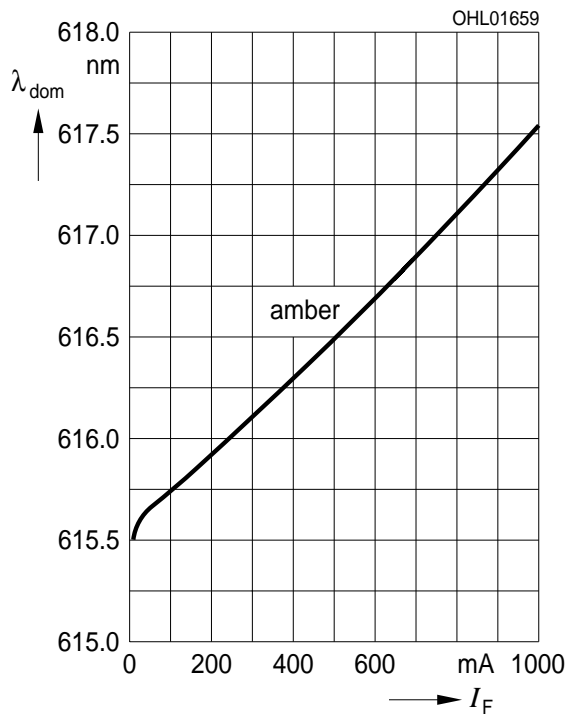

Dominante Wellenlänge²⁾ Seite 17

Dominant Wavelength²⁾ page 17

LT, $\lambda_{\text{dom}} = f(I_F)$; $T_{\text{board}} = 25\text{ °C}$

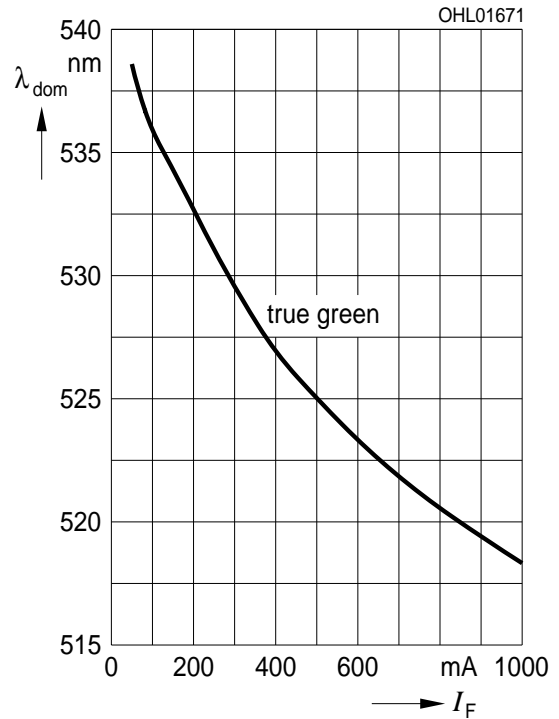

Dominante Wellenlänge²⁾ Seite 17

Dominant Wavelength²⁾ page 17

LB, $\lambda_{\text{dom}} = f(I_F)$; $T_{\text{board}} = 25\text{ °C}$

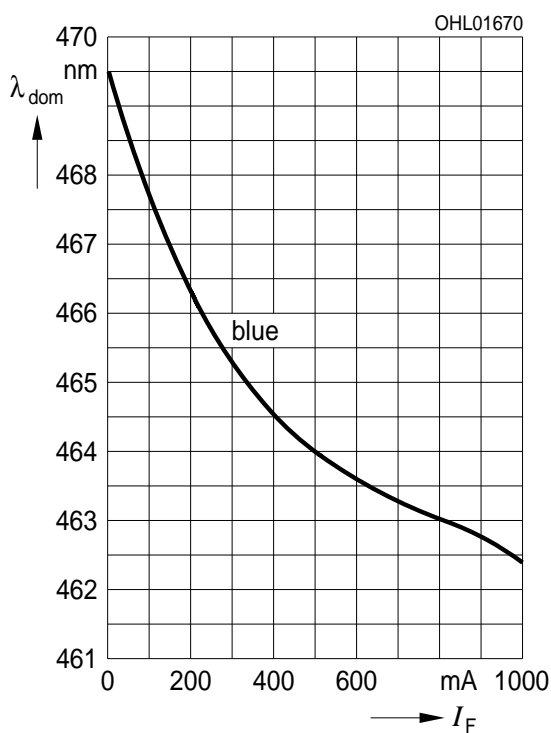

Relative Vorwärtsspannung²⁾ Seite 17

Relative Forward Voltage²⁾ page 17

$$\Delta V_F = V_F - V_{F(25\text{ }^\circ\text{C})} = f(T_j); I_F = 750\text{ mA amber}$$

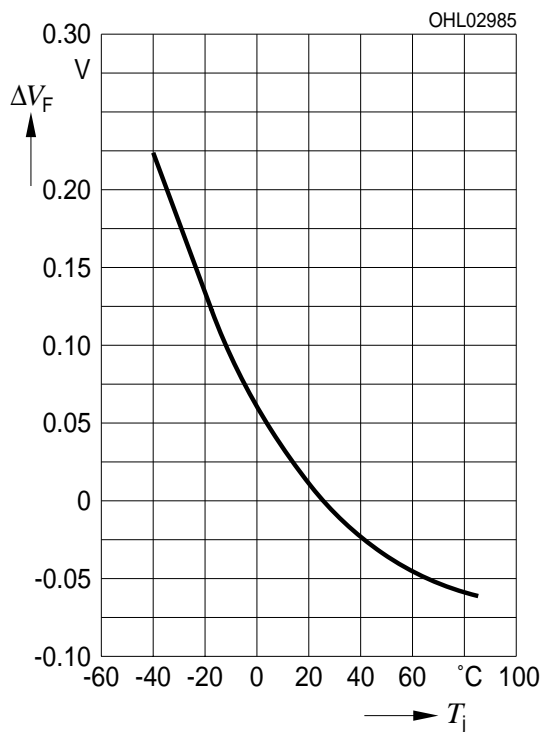

Relative Vorwärtsspannung²⁾ Seite 17

Relative Forward Voltage²⁾ page 17

$$\Delta V_F = V_F - V_{F(25\text{ }^\circ\text{C})} = f(T_j); I_F = 500\text{ mA (blue/true green)}$$

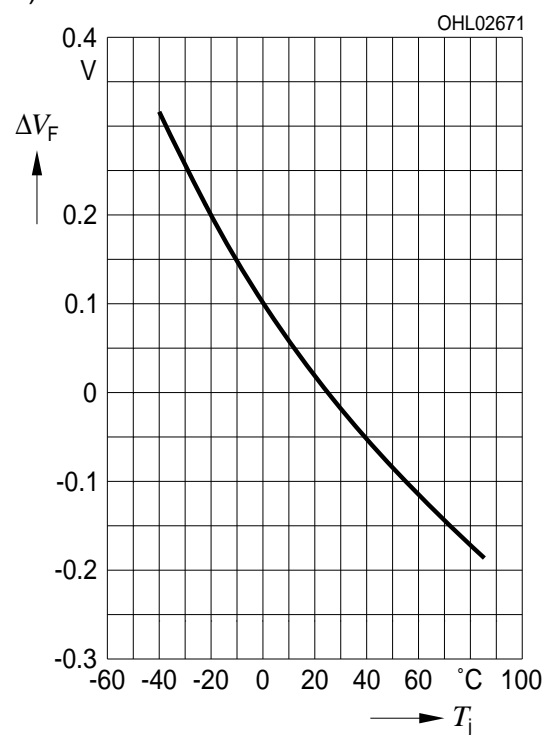

Maximal zulässiger Durchlassstrom
Max. Permissible Forward Current

1 Chip on; $I_F = f(T_S)$

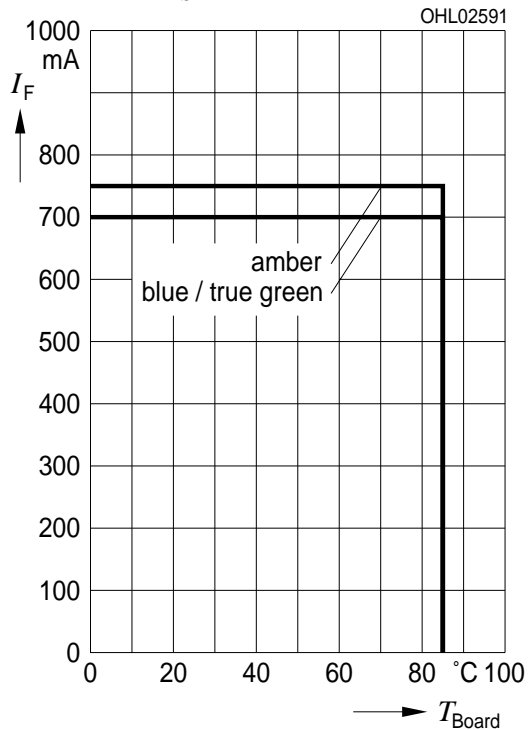

Maximal zulässiger Durchlassstrom für 2 Chip
Max. Permissible Forward Current for 2 Chip

(operated parallel; current for single chip is $I_F/2$) $I_F = f(T_S)$

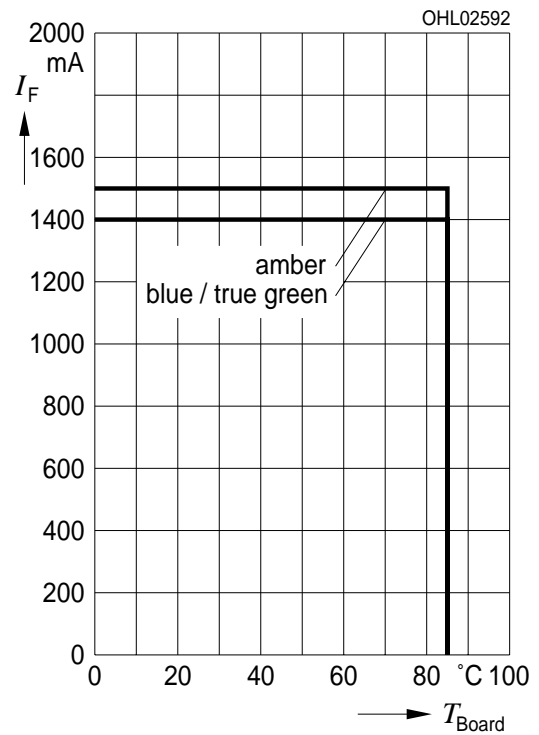

Maximal zulässiger Durchlassstrom für 4 Chip
Max. Permissible Forward Current for 4 Chip

(operated parallel; current for single chip is $I_F/4$) $I_F = f(T_S)$

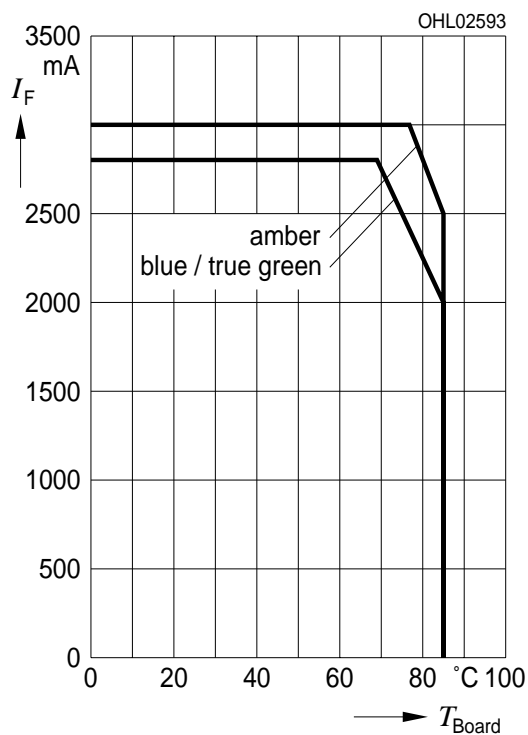

Zulässige Impulsbelastbarkeit $I_F = f(t_p)$
 Permissible Pulse Handling Capability

amber Duty cycle $D =$ parameter, $T_{board} = 25\text{ °C}$
 1 chip operated

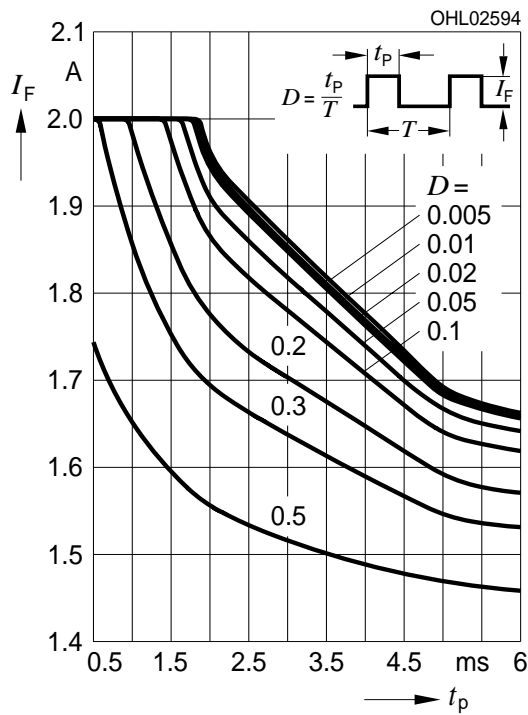

Zulässige Impulsbelastbarkeit $I_F = f(t_p)$
 Permissible Pulse Handling Capability

blue, true green Duty cycle $D =$ parameter, $T_{board} = 25\text{ °C}$
 1 chip operated

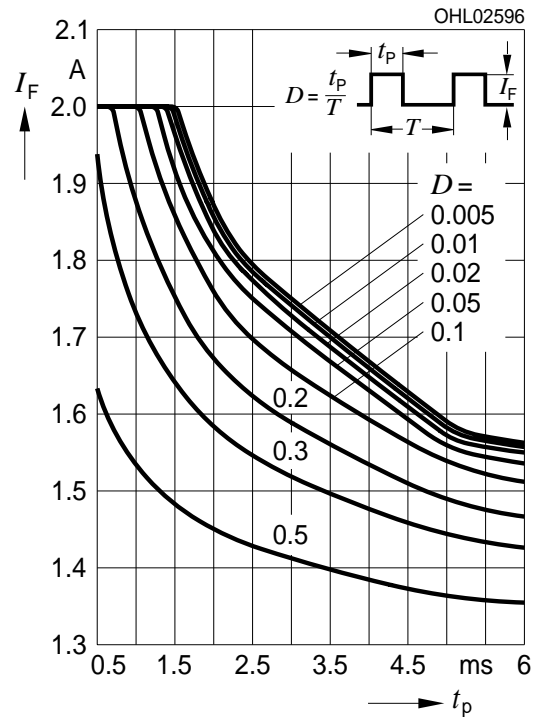

Zulässige Impulsbelastbarkeit $I_F = f(t_p)$
 Permissible Pulse Handling Capability

amber Duty cycle $D =$ parameter, $T_{board} = 85\text{ °C}$
 1 chip operated

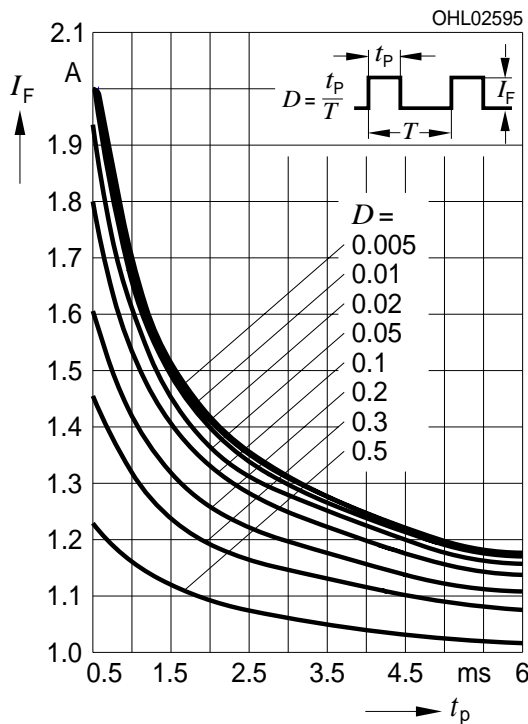

Zulässige Impulsbelastbarkeit $I_F = f(t_p)$
 Permissible Pulse Handling Capability

blue, true green Duty cycle $D =$ parameter, $T_{board} = 85\text{ °C}$
 1 chip operated

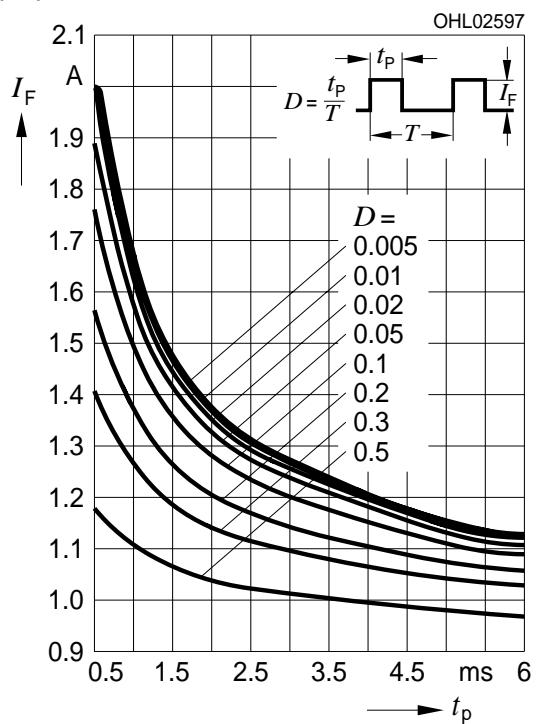

Zulässige Impulsbelastbarkeit $I_F = f(t_p)$
Permissible Pulse Handling Capability

true green Duty cycle $D =$ parameter, $T_{\text{board}} = 25^\circ\text{C}$
 2 chips operated parallel; current for single chip is $I_F/2$

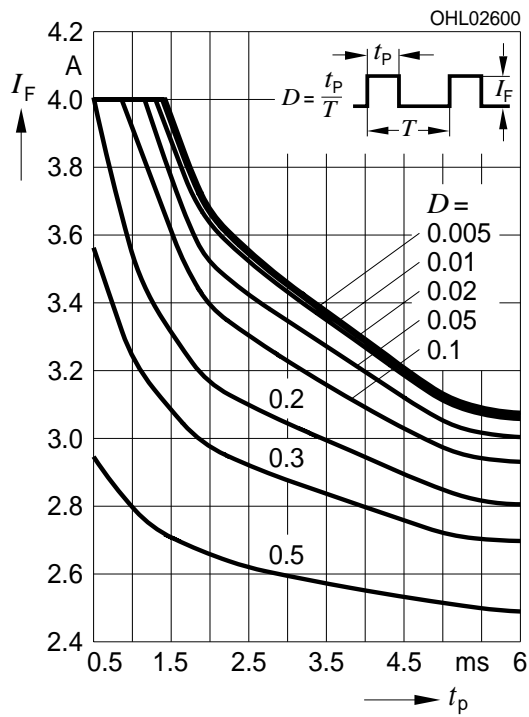

Zulässige Impulsbelastbarkeit $I_F = f(t_p)$
Permissible Pulse Handling Capability

true green Duty cycle $D =$ parameter, $T_{\text{board}} = 85^\circ\text{C}$
 2 chips operated parallel; current for single chip is $I_F/2$

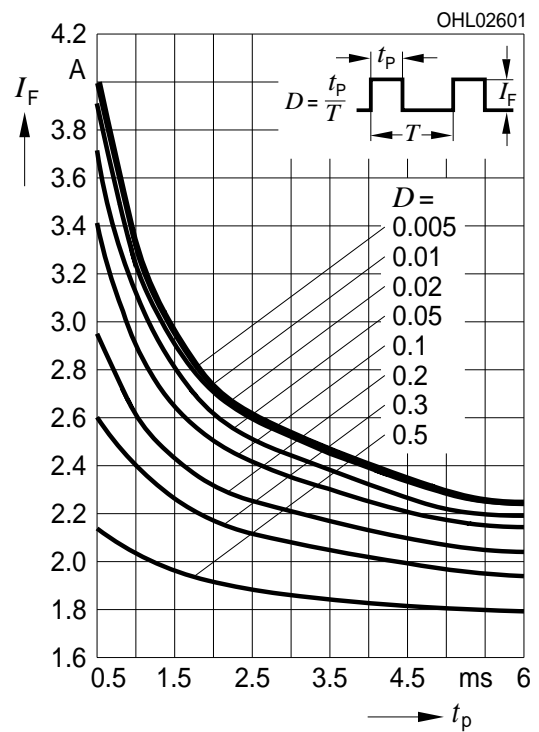

Ersatzschaltbild für den thermischen Widerstand²⁾ Seite 17

Analogon lay out for thermal resistance²⁾ page 17

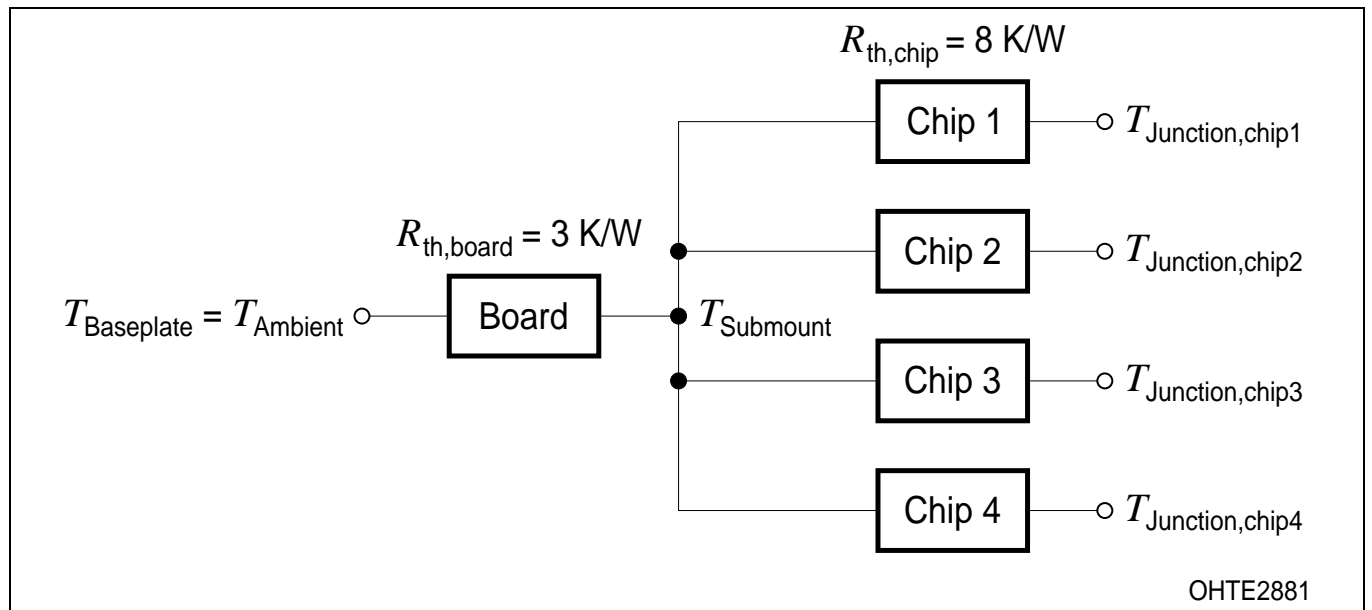

Verpackung⁹⁾ Seite 17

25 St. pro Box = Verpackungseinheit

Method of Packing⁹⁾ page 17

25 pcs. per tray = packing unit

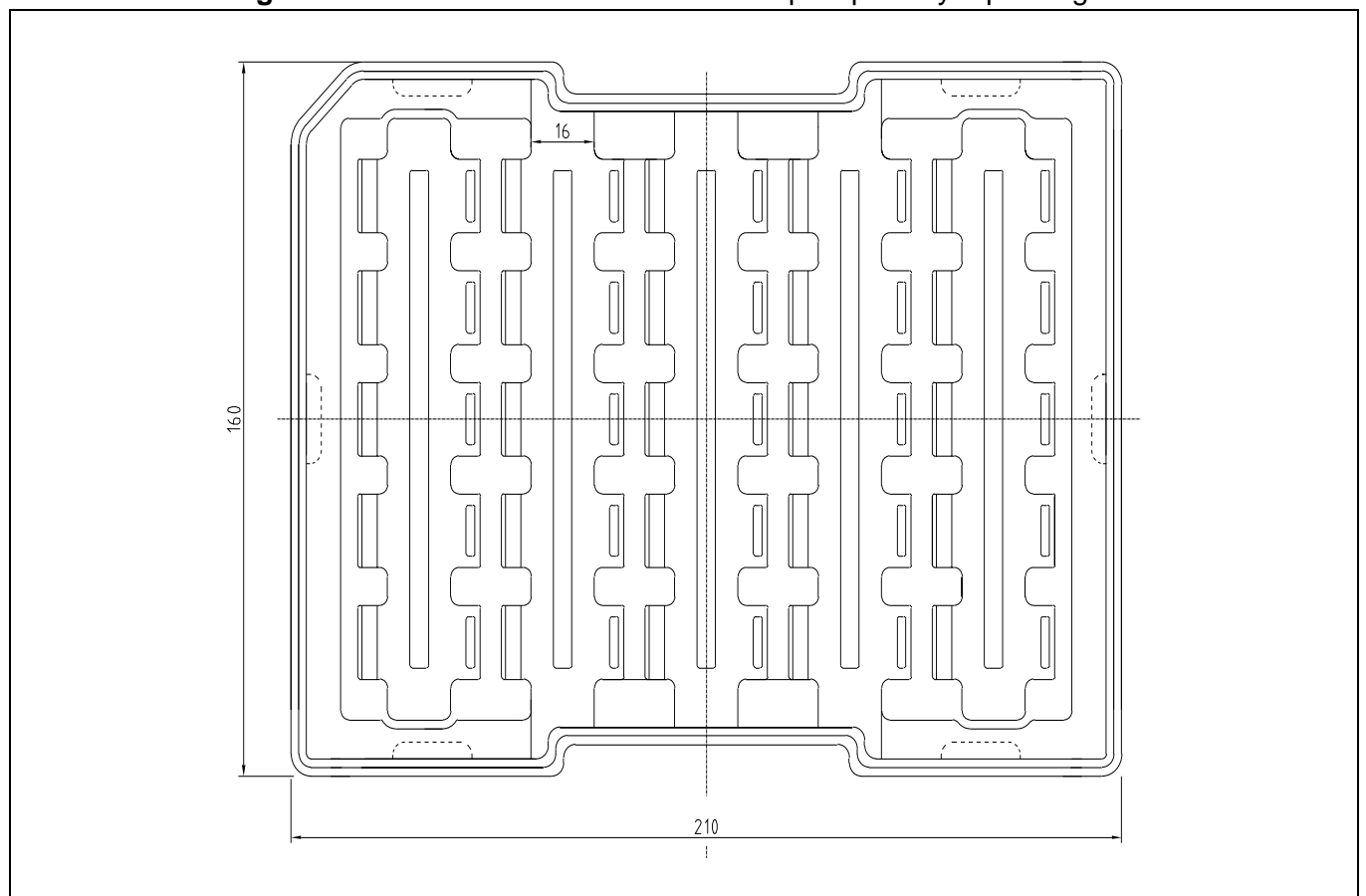

Barcode-Tray-Etikett (BTL)
Barcode-Tray-Label (BTL)

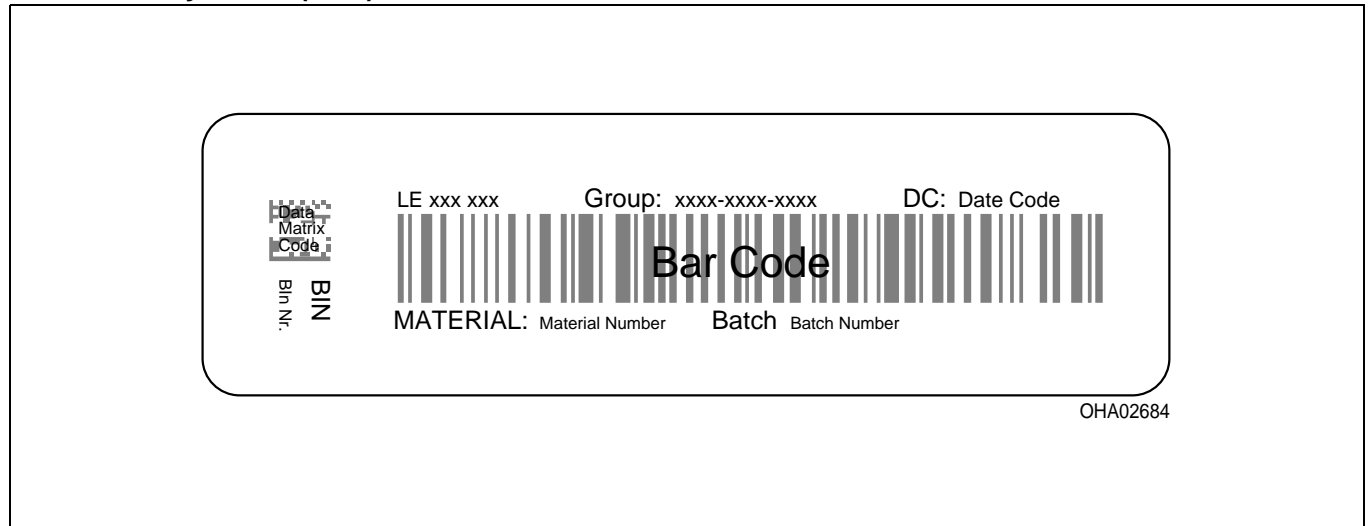

Kartonverpackung und Materialien
Transportation Packing and Materials

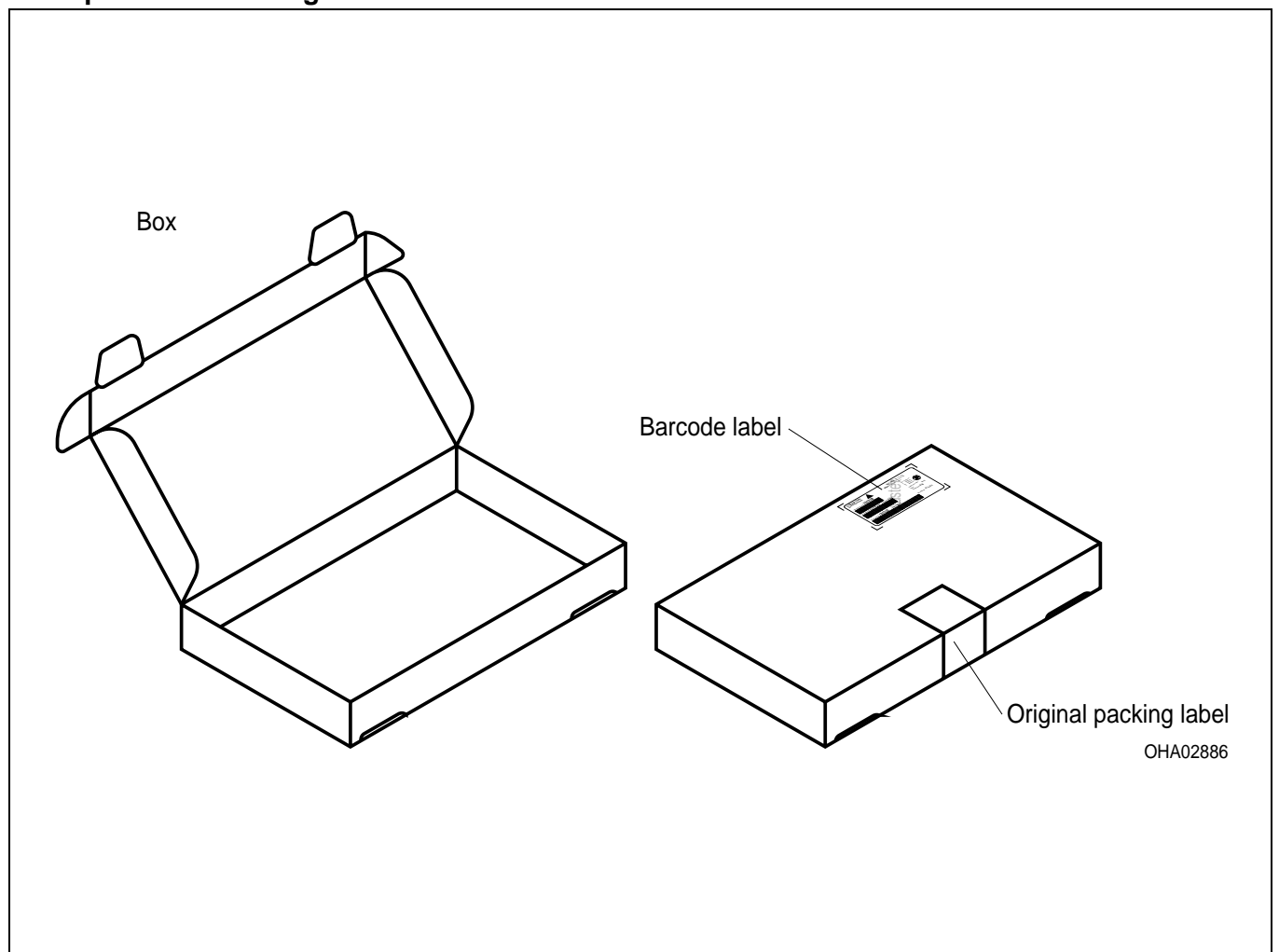

Revision History: 2008-12-15

Previous Version: 2006-09-27

Page	Subjects (major changes since last revision)	Date of change
8	Relative Forward Voltage	2006-08-08
all	Product Discontinuation OS-PD-2008-016	2008-12-15

Anm.: Gemäß IEC 60825-1 (EN 60825-1) gilt für amber, true green:

Note: According IEC 60825-1 (EN 60825-1) for amber, true green:

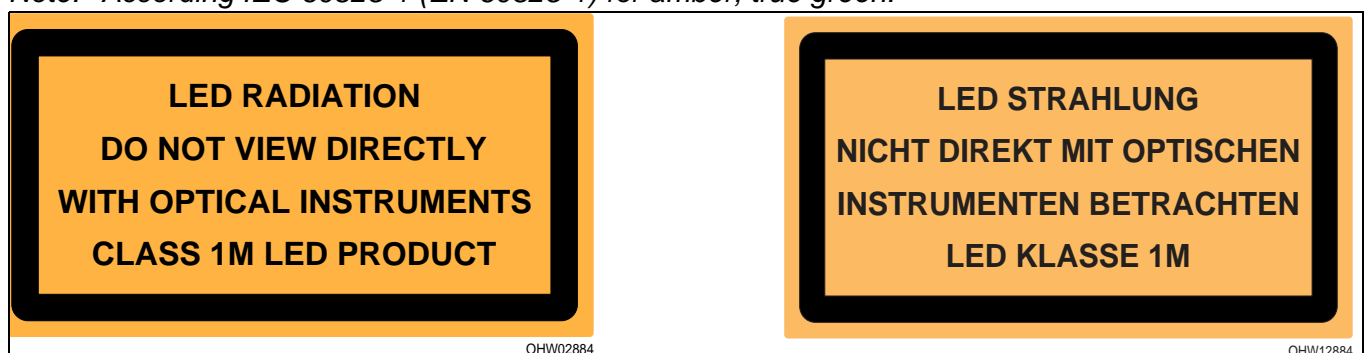

Anm.: Gemäß IEC 60825-1 (EN 60825-1) gilt für blau:

Note: According IEC 60825-1 (EN 60825-1) for blue:

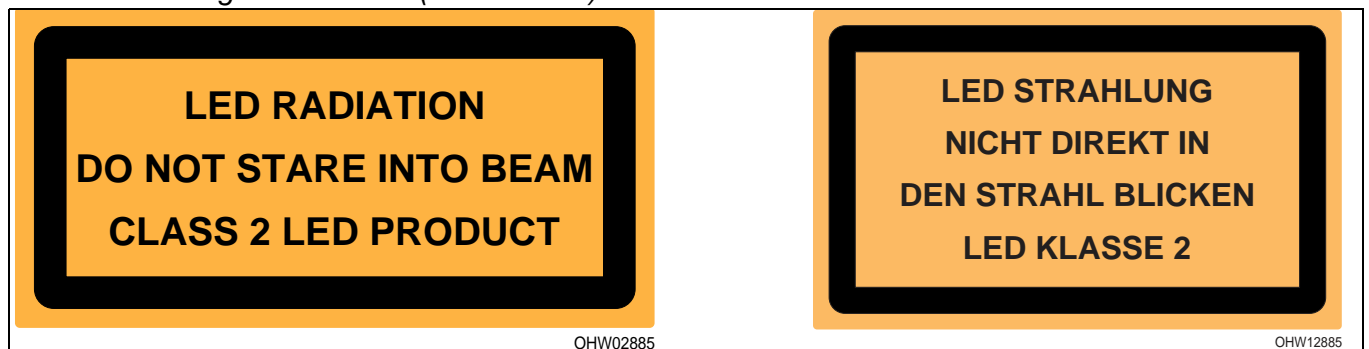

Attention please!

The information describes the type of component and shall not be considered as assured characteristics.

Terms of delivery and rights to change design reserved. Due to technical requirements components may contain dangerous substances. For information on the types in question please contact our Sales Organization.

If printed or downloaded, please find the latest version in the Internet.

Packing

Please use the recycling operators known to you. We can also help you – get in touch with your nearest sales office. By agreement we will take packing material back, if it is sorted. You must bear the costs of transport. For packing material that is returned to us unsorted or which we are not obliged to accept, we shall have to invoice you for any costs incurred.

Components used in life-support devices or systems must be expressly authorized for such purpose! Critical components¹⁰⁾ page 17 may only be used in life-support devices or systems¹¹⁾ page 17 with the express written approval of OSRAM OS.

Fußnoten:

- 1) Helligkeitswerte werden mit einer Stromeinprägedauer von 25 ms und einer Genauigkeit von $\pm 11\%$ ermittelt. Messbedingung für Lichtstärkemessung nach CIE127 Condition A.
- 2) Wegen der besonderen Prozessbedingungen bei der Herstellung von LED können typische oder abgeleitete technische Parameter nur aufgrund statistischer Werte wiedergegeben werden. Diese stimmen nicht notwendigerweise mit den Werten jedes einzelnen Produktes überein, dessen Werte sich von typischen und abgeleiteten Werten oder typischen Kennlinien unterscheiden können. Falls erforderlich, z.B. aufgrund technischer Verbesserungen, werden diese typischen Werte ohne weitere Ankündigung geändert.
- 3) Min. Φ_V Werte werden aus den I_V - Werten berechnet. Die Helligkeitswerte auf Seite 2 wurden ohne Primäroptik gemessen.
- 4) Wellenlängen werden mit einer Stromeinprägedauer von 25 ms und einer Genauigkeit von ± 1 nm ermittelt.
- 5) Spannungswerte werden mit einer Stromeinprägedauer von 1 ms und einer Genauigkeit von $\pm 0,1$ V ermittelt.
- 6) Für den Fall, dass eine Optik wie z. B. eine Halbsphärenlinse als Primäroptik verwendet wird, kann der Lichtfluss bis zu 40% für rot und grün und 36% für blau erhöht werden.
- 7) Die R-T-Kurve eines NTC läßt sich in einem engen Bereich um den spezifizierten Wert herum in erster Näherung durch einen exponentialen Zusammenhang beschreiben. Sofern eine detailliertere Beschreibung der R-T-Kurve für die Praxis nötig ist, können eine genauere Formel und entsprechende tabellierte Werte bei EPCOS gefunden werden.
- 8) Im gestrichelten Bereich der Kennlinien muss mit erhöhten Helligkeitsunterschieden zwischen Leuchtdioden innerhalb einer Verpackungseinheit gerechnet werden.
- 9) Maße werden wie folgt angegeben: mm (inch).
- 10) Ein kritisches Bauteil ist ein Bauteil, das in lebenserhaltenden Apparaten oder Systemen eingesetzt wird und dessen Defekt voraussichtlich zu einer Fehlfunktion dieses lebenserhaltenden Apparates oder Systems führen wird oder die Sicherheit oder Effektivität dieses Apparates oder Systems beeinträchtigt.
- 11) Lebenserhaltende Apparate oder Systeme sind für (a) die Implantierung in den menschlichen Körper oder (b) für die Lebenserhaltung bestimmt. Falls sie versagen, kann davon ausgegangen werden, dass die Gesundheit und das Leben des Patienten in Gefahr ist.

Remarks:

- 1) Brightness groups are tested at a current pulse duration of 25 ms and a tolerance of $\pm 11\%$. Condition for luminous intensity measurement acc. to CIE127 condition A
- 2) Due to the special conditions of the manufacturing processes of LED, the typical data or calculated correlations of technical parameters can only reflect statistical figures. These do not necessarily correspond to the actual parameters of each single product, which could differ from the typical data and calculated correlations or the typical characteristic line. If requested, e.g. because of technical improvements, these typ. data will be changed without any further notice.
- 3) Min. Φ_V values are calculated from I_V values. Brightness values stated on page 2 are measured without primary optics.
- 4) Wavelengths are tested at a current pulse duration of 25 ms and a tolerance of ± 1 nm.
- 5) Forward voltages are tested at a current pulse duration of 1 ms and a tolerance of ± 0.1 V.
- 6) If an optic, such as a hemispherical lens is added, the luminous flux values can be increased up to 40% for red and green and 36% for blue.
- 7) The R-T-Curve of an NTC thermistor can be roughly described in a restricted range around the rated temperature. If a more precise description of the R/T curve is required for practical applications a refined formula and the corresponding tabulated values can be found at EPCOS
- 8) In the range where the line of the graph is broken, you must expect higher brightness differences between single LEDs within one packing unit.
- 9) Dimensions are specified as follows: mm (inch).
- 10) A critical component is a component used in a life-support device or system whose failure can reasonably be expected to cause the failure of that life-support device or system, or to affect its safety or the effectiveness of that device or system.
- 11) Life support devices or systems are intended (a) to be implanted in the human body, or (b) to support and/or maintain and sustain human life. If they fail, it is reasonable to assume that the health and the life of the user may be endangered.

Published by
OSRAM Opto Semiconductors GmbH
 Wernerwerkstrasse 2, D-93049 Regensburg
www.osram-os.com
 © All Rights Reserved.

EU RoHS and China RoHS compliant product



此产品符合欧盟 RoHS 指令的要求；

按照中国的相关法规和标准，不含有毒有害物质或元素。