

CM1225

4-Channel Low Capacitance ESD Protection Arrays

Product Description

The CM1225 diode array has been designed to provide ESD protection for electronic components or subsystems requiring minimal capacitive loading. This device is ideal for protecting systems with high data and clock rates or for circuits requiring low capacitive loading. Each ESD channel consists of a pair of diodes in series which steer the positive or negative ESD current pulse to the ground pins (V_N). A Zener diode is embedded between the positive terminal of the diode pair to the ground. This eliminates the need for an external bypass capacitor to absorb positive ESD strikes to ground. The CM1225 protects against ESD pulses up to ± 8 kV per the IEC 61000-4-2 standard.

The CM1225 is particularly well-suited for protecting systems using high-speed ports such as HDMI, DVI, display, MDDI, USB 2.0, Serial ATA, IEEE1394 (FireWire and i.LINK), corresponding ports in removable storage, digital camcorders, DVD-RW drives and other applications where extremely low loading capacitance with ESD protection are required in a small package footprint.

The CM1225 is available in a RoHS-compliant, uUDFN 10-pin package.

Features

- Four Channels of ESD Protection
- Provides ESD Protection to IEC61000-4-2 Level 4 ± 8 kV Contact Discharge
- Low Channel Input Capacitance of 0.8 pF (Typically)
- Channel Input Capacitance Matching (I/O to I/O) of 0.02 pF (Typically) is Ideal for Differential Signals
- Minimal Capacitance Change for Temperature and Voltage
- Zener Diode Eliminates the Need for External Bypass Capacitors
- Each I/O Pin Can Withstand Over 1000 ESD Strikes*
- These Devices are Pb-Free and are RoHS Compliant

Applications

- DVI Ports, HDMI Ports in Notebooks, Set Top Boxes, Digital TVs, LCD Displays
- Display and MDDI Ports
- Serial ATA Ports in Desktop PCs and Hard Disk Drives
- PCI Express Ports
- USB2.0 Ports at 480 Mbps in desktop PCs, Notebooks and Peripherals
- IEEE1394 FireWire Ports at 400 Mbps / 800 Mbps
- General Purpose High-speed Data Line ESD Protection
- Protection of Interface Ports or IC Pins which are Exposed to High ESD Levels

*Standard test condition is IEC61000-4-2 level 4 test circuit with each pin subjected to ± 8 kV contact discharge for 1000 pulses. Discharges are timed at 1 second intervals and all 1000 strikes are completed in one continuous test run. The part is then subjected to standard production test to verify that all of the tested parameters are within spec after the 1000 strikes.



ON Semiconductor®

<http://onsemi.com>



uUDFN-10
DE SUFFIX
CASE 517BB

BLOCK DIAGRAM

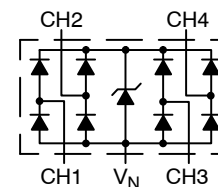

CM1225-04DE

MARKING DIAGRAM

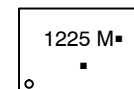

1225 = Specific Device Code
M = Date Code
▪ = Pb-Free Package
(Note: Microdot may be in either location)

ORDERING INFORMATION

Device	Package	Shipping
CM1225-04DE	uUDFN-10 (Pb-Free)	3000/Tape & Reel

†For information on tape and reel specifications, including part orientation and tape sizes, please refer to our Tape and Reel Packaging Specification Brochure, BRD8011/D.

Table 1. PIN DESCRIPTIONS

4-Channel, 10-Lead uUDFN-10 Package			
Pin	Name	Type	Description
1	CH1	I/O	ESD Channel
2	CH2	I/O	ESD Channel
3	V _N	GND	Ground
4	CH3	I/O	ESD Channel
5	CH4	I/O	ESD Channel
6	NC		No Connect
7	NC		No Connect
8	V _N	GND	Ground
9	NC		No Connect
10	NC		No Connect

PACKAGE / PINOUT DIAGRAMS

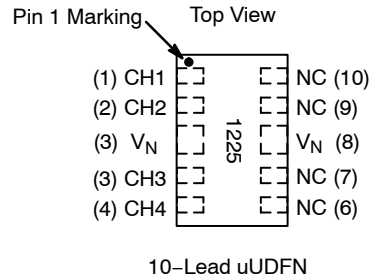

SPECIFICATIONS

Table 2. ABSOLUTE MAXIMUM RATINGS

Parameter	Rating	Units
Operating Temperature Range	-40 to +85	°C
Storage Temperature Range	-65 to +150	°C
DC Voltage at any Channel Input	- 0.5 to + 5.5	V

Stresses exceeding Maximum Ratings may damage the device. Maximum Ratings are stress ratings only. Functional operation above the Recommended Operating Conditions is not implied. Extended exposure to stresses above the Recommended Operating Conditions may affect device reliability.

Table 3. STANDARD OPERATING CONDITIONS

Parameter	Rating	Units
Operating Temperature Range	-40 to +85	°C

Table 4. ELECTRICAL OPERATING CHARACTERISTICS (Note1)

Symbol	Parameter	Conditions	Min	Typ	Max	Units
V _F	Diode Forward Voltage Top Diode Bottom Diode	I _F = 10 mA; T _A = 25°C; Note 2	0.65 -1.20	0.85 -0.85	1.20 -0.65	V
I _{LEAK}	Channel Leakage Current	T _A = 25°C; V _{IN} = 3.3 V, V _N = 0 V		±0.1	±1.0	µA
C _{IN}	Channel Input Capacitance	At 1 MHz, V _N = 0 V, V _{IN} = 1.65 V		0.8	1.0	pF
ΔC _{IN}	Channel Input Capacitance Matching	At 1 MHz, V _N = 0 V, V _{IN} = 1.65 V		0.02		pF
V _{ESD}	ESD Protection – Peak Discharge Voltage at any Channel Input, in system Contact discharge per IEC 61000-4-2 standard	T _A = 25°C; (Notes 2 and 3)		±8		kV
V _{CL}	Channel Clamp Voltage Positive Transients Negative Transients	T _A = 25°C, I _{PP} = 1 A, t _P = 8/20 µS; (Note 3)		+10 -4.5		V
R _{DYN}	Dynamic Resistance Positive Transients Negative Transients	I _{PP} = 1 A, t _P = 8/20 µS Any I/O pin to Ground; (Note 3)		1.3 1.3		Ω

1. All parameters specified at T_A = -40°C to +85°C unless otherwise noted.
2. Standard IEC 61000-4-2 with C_{Discharge} = 150 pF, R_{Discharge} = 330 Ω, V_P = 3.3 V, V_N grounded.
3. These measurements performed with no external capacitor.

PERFORMANCE INFORMATION

Input Channel Capacitance Performance Curves

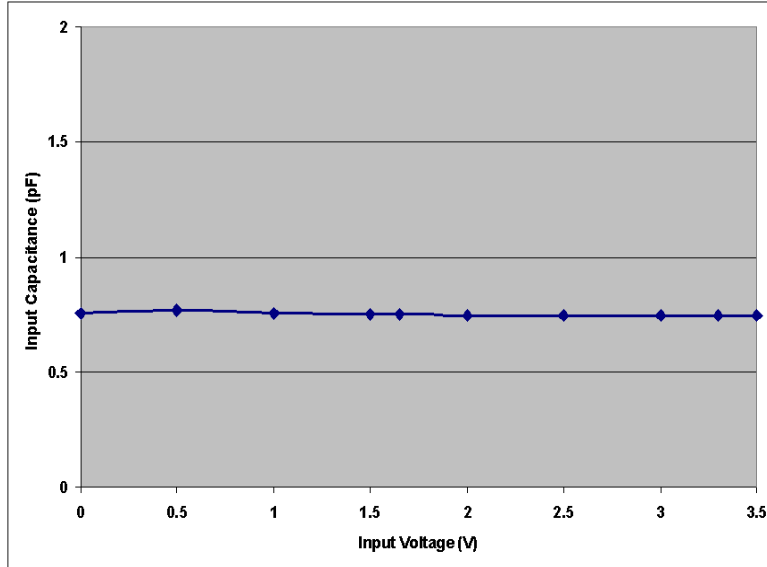

Figure 1. Typical Variation of C_{IN} vs. V_{IN}
($f = 1 \text{ Mhz}$, $V_N = 0 \text{ V}$, $T = 25^\circ\text{C}$)

CM1225

PERFORMANCE INFORMATION (Cont'd)

Typical Filter Performance (nominal conditions unless specified otherwise, 50 Ohm Environment)

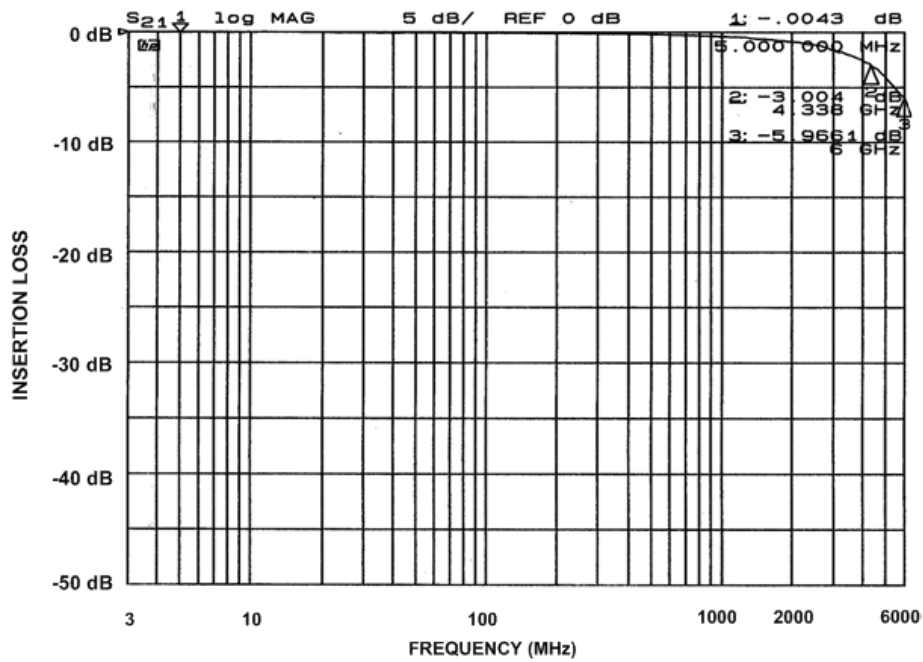

Figure 2. Insertion Loss (S21) vs. Frequency (0 V DC Bias)

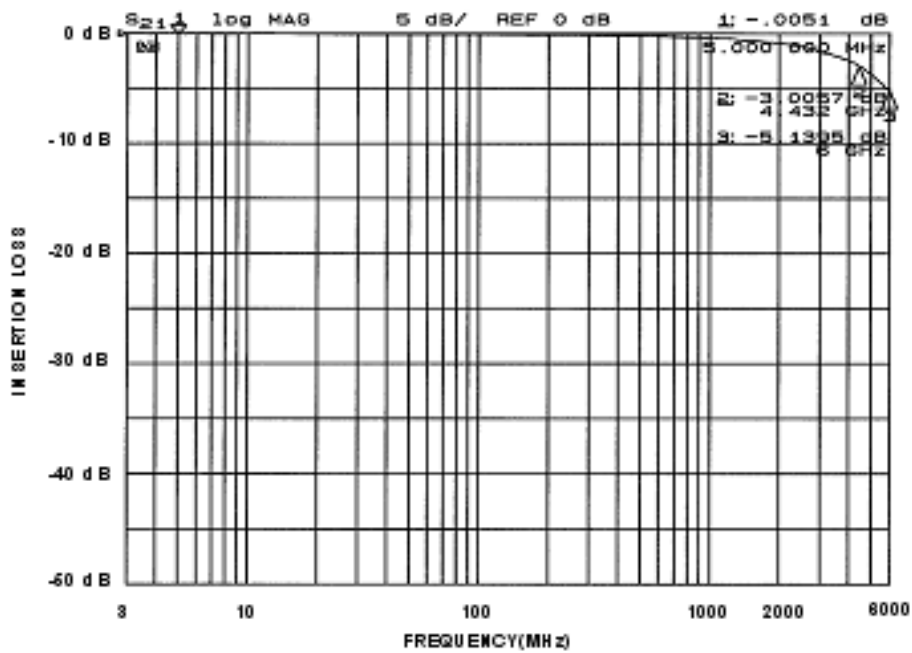

Figure 3. Insertion Loss (S21) vs. Frequency (2.5 V DC Bias)

CM1225

APPLICATION INFORMATION

Design Considerations

As a general rule, the CM1225 ESD protection array should be located as close as possible to the point of entry of expected electrostatic discharges. Use minimum PCB trace lengths to ground planes and between the signal input and the ESD devices.

Additional Information

See also ON Semiconductor Application Note “Design Considerations for ESD Protection”.

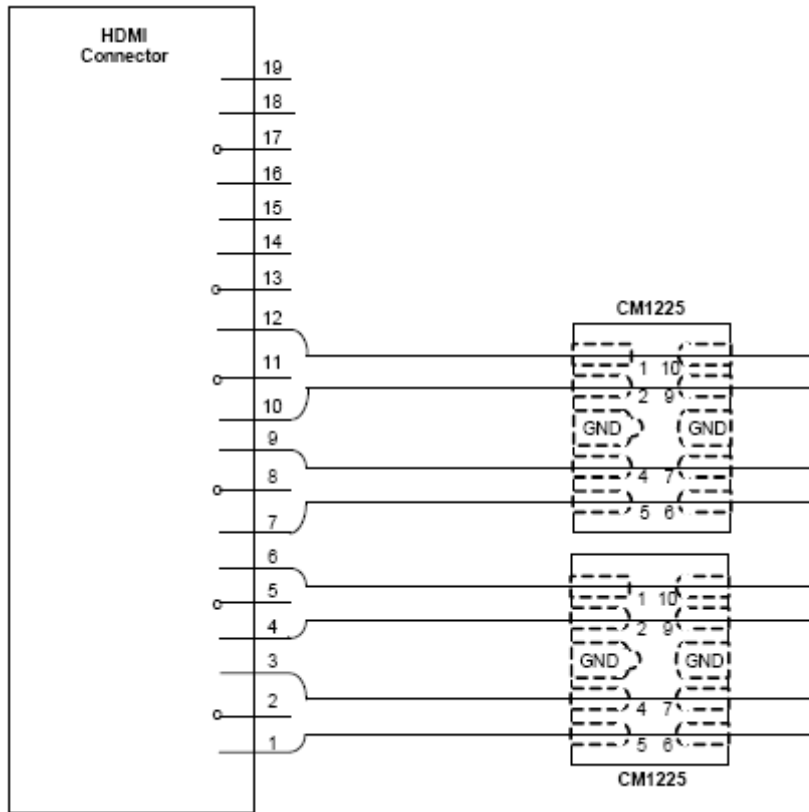

Figure 4. Typical HDMI ESD Protection with CM1225 Connection

CM1225

APPLICATION INFORMATION (Cont'd)

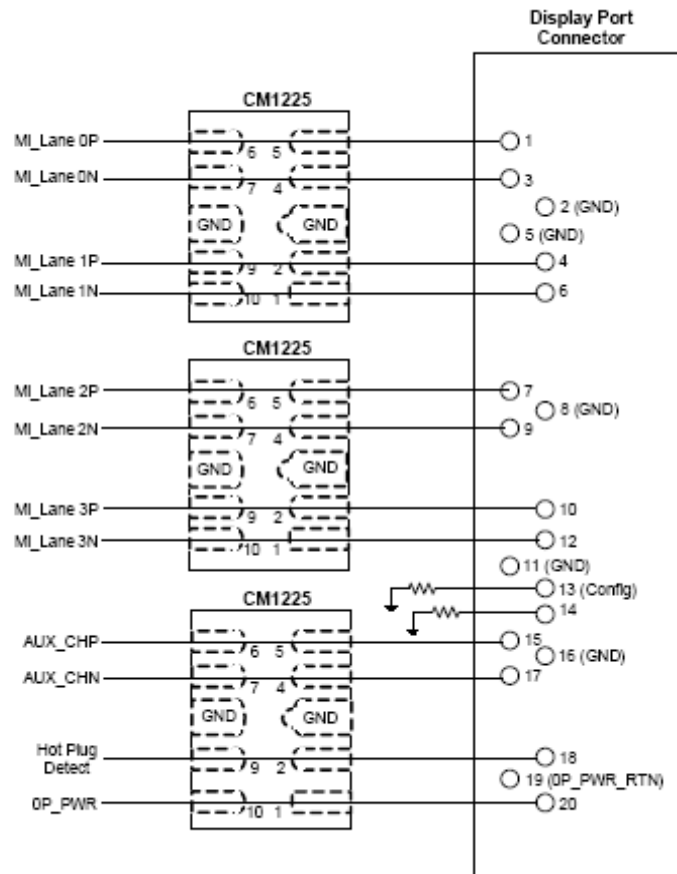

Figure 5. Display Port ESD Protection with CM1225 Connection

CM1225

MECHANICAL DETAILS

uUDFN-10 Mechanical Specifications, 0.5 mm

The 10-lead, 0.5 mm pitch uUDFN package dimensions are presented below.

Table 5. TAPE AND REEL SPECIFICATIONS

Part Number	Chip Size (mm)	Pocket Size (mm) $B_0 \times A_0 \times K_0$	Tape Width W	Reel Diameter	Qty per Reel	P_0	P_1
CM1225	2.50 X 1.00 X 0.50	2.80 X 1.45 X 0.70	8 mm	178 mm (7")	3000	4 mm	4 mm

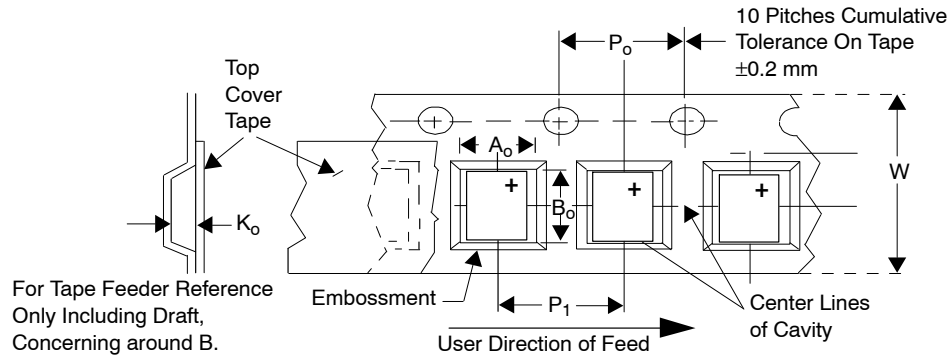

MECHANICAL CASE OUTLINE

PACKAGE DIMENSIONS

ON Semiconductor®



UDFN10 2.5x1, 0.5P
CASE 517BB-01
ISSUE O

DATE 17 NOV 2009

SCALE 4:1

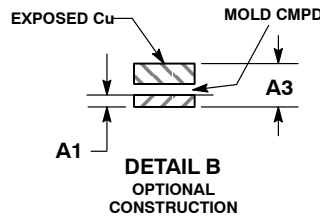
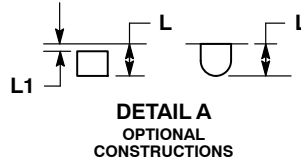
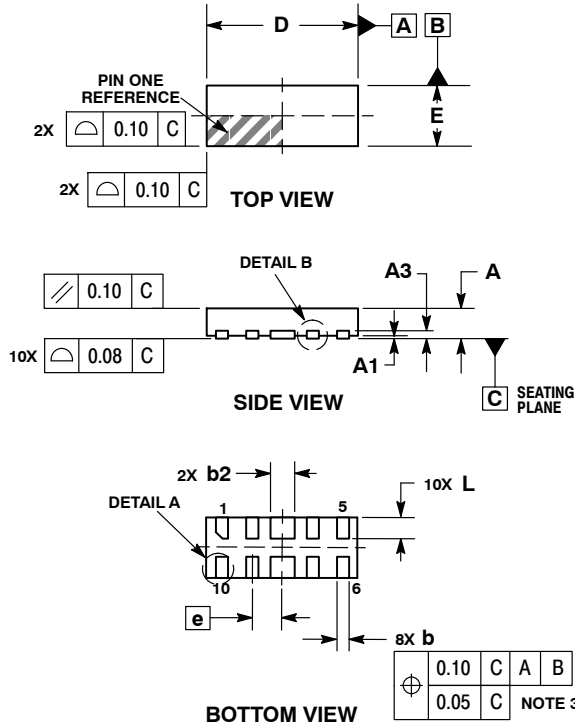

- NOTES:
1. DIMENSIONING AND TOLERANCING PER ASME Y14.5M, 1994.
 2. CONTROLLING DIMENSION: MILLIMETERS.
 3. DIMENSION b APPLIES TO PLATED TERMINAL AND IS MEASURED BETWEEN 0.15 AND 0.30mm FROM TERMINAL.

DIM	MILLIMETERS	
	MIN	MAX
A	0.45	0.55
A1	0.00	0.05
A3	0.13 REF	
b	0.15	0.25
b2	0.35	0.45
D	2.50 BSC	
E	1.00 BSC	
e	0.50 BSC	
L	0.30	0.40
L1	---	0.05

GENERIC MARKING DIAGRAM*

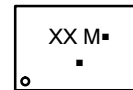

- XXX = Specific Device Code
- M = Date Code
- = Pb-Free Package

(Note: Microdot may be in either location)

*This information is generic. Please refer to device data sheet for actual part marking. Pb-Free indicator, "G" or microdot "▪", may or may not be present.

RECOMMENDED SOLDERING FOOTPRINT*

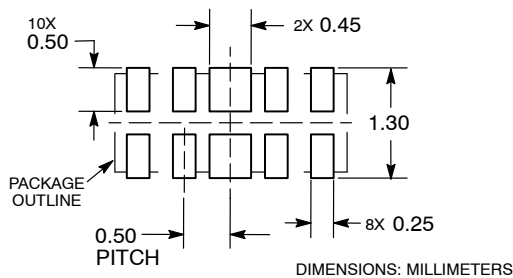

*For additional information on our Pb-Free strategy and soldering details, please download the ON Semiconductor Soldering and Mounting Techniques Reference Manual, SOLDERRM/D.

DOCUMENT NUMBER:	98AON47059E	Electronic versions are uncontrolled except when accessed directly from the Document Repository. Printed versions are uncontrolled except when stamped "CONTROLLED COPY" in red.
DESCRIPTION:	UDFN10 2.5X1, 0.5P	PAGE 1 OF 1

ON Semiconductor and are trademarks of Semiconductor Components Industries, LLC dba ON Semiconductor or its subsidiaries in the United States and/or other countries. ON Semiconductor reserves the right to make changes without further notice to any products herein. ON Semiconductor makes no warranty, representation or guarantee regarding the suitability of its products for any particular purpose, nor does ON Semiconductor assume any liability arising out of the application or use of any product or circuit, and specifically disclaims any and all liability, including without limitation special, consequential or incidental damages. ON Semiconductor does not convey any license under its patent rights nor the rights of others.

onsemi, **Onsemi**, and other names, marks, and brands are registered and/or common law trademarks of Semiconductor Components Industries, LLC dba "**onsemi**" or its affiliates and/or subsidiaries in the United States and/or other countries. **onsemi** owns the rights to a number of patents, trademarks, copyrights, trade secrets, and other intellectual property. A listing of **onsemi**'s product/patent coverage may be accessed at www.onsemi.com/site/pdf/Patent-Marking.pdf. **onsemi** reserves the right to make changes at any time to any products or information herein, without notice. The information herein is provided "as-is" and **onsemi** makes no warranty, representation or guarantee regarding the accuracy of the information, product features, availability, functionality, or suitability of its products for any particular purpose, nor does **onsemi** assume any liability arising out of the application or use of any product or circuit, and specifically disclaims any and all liability, including without limitation special, consequential or incidental damages. Buyer is responsible for its products and applications using **onsemi** products, including compliance with all laws, regulations and safety requirements or standards, regardless of any support or applications information provided by **onsemi**. "Typical" parameters which may be provided in **onsemi** data sheets and/or specifications can and do vary in different applications and actual performance may vary over time. All operating parameters, including "Typicals" must be validated for each customer application by customer's technical experts. **onsemi** does not convey any license under any of its intellectual property rights nor the rights of others. **onsemi** products are not designed, intended, or authorized for use as a critical component in life support systems or any FDA Class 3 medical devices or medical devices with a same or similar classification in a foreign jurisdiction or any devices intended for implantation in the human body. Should Buyer purchase or use **onsemi** products for any such unintended or unauthorized application, Buyer shall indemnify and hold **onsemi** and its officers, employees, subsidiaries, affiliates, and distributors harmless against all claims, costs, damages, and expenses, and reasonable attorney fees arising out of, directly or indirectly, any claim of personal injury or death associated with such unintended or unauthorized use, even if such claim alleges that **onsemi** was negligent regarding the design or manufacture of the part. **onsemi** is an Equal Opportunity/Affirmative Action Employer. This literature is subject to all applicable copyright laws and is not for resale in any manner.

ADDITIONAL INFORMATION

TECHNICAL PUBLICATIONS:

Technical Library: www.onsemi.com/design/resources/technical-documentation
onsemi Website: www.onsemi.com

ONLINE SUPPORT: www.onsemi.com/support

For additional information, please contact your local Sales Representative at www.onsemi.com/support/sales