

8

7

6

5

4

3

2

1

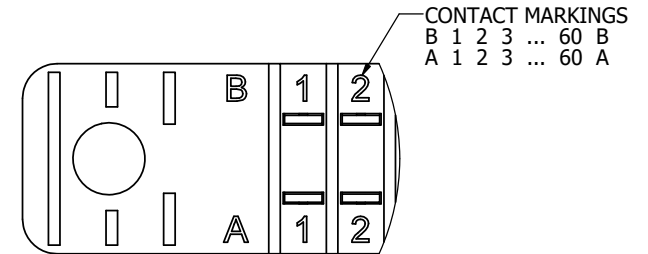
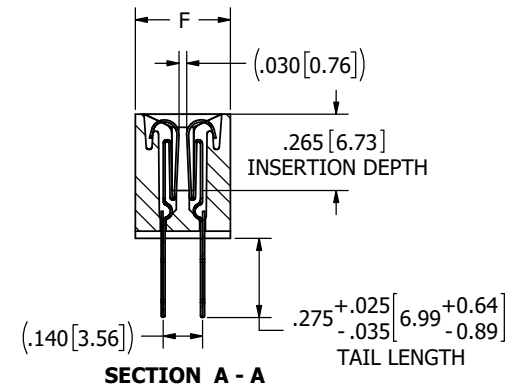
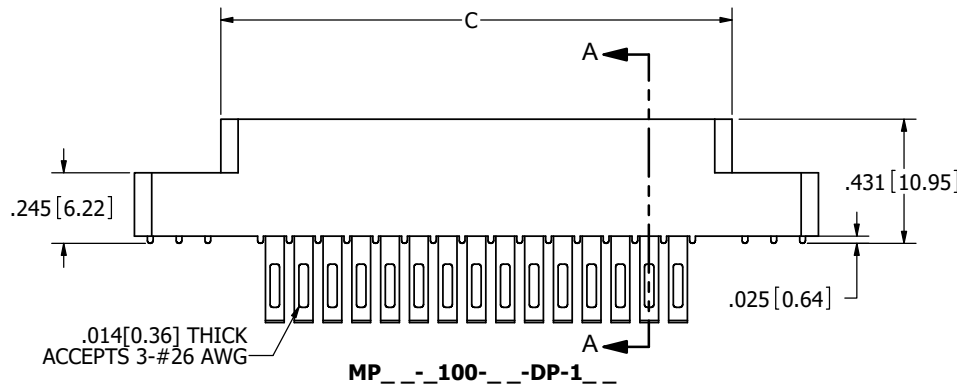
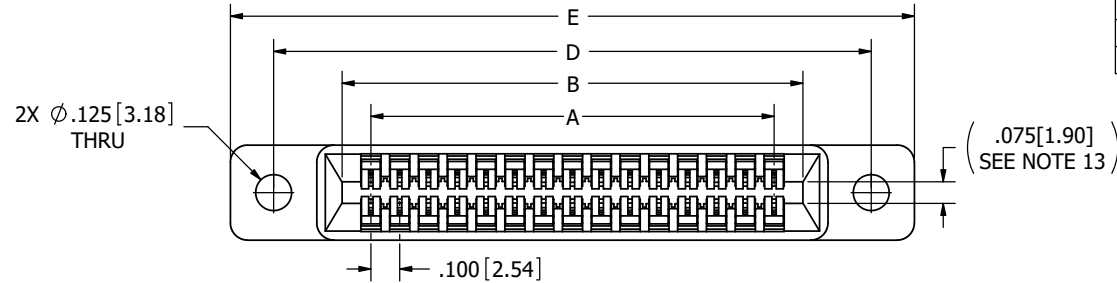

CONTACT ID  
SCALE 6:1

REF: \_\_C\_\_DTE\_ (-S38, S81, S328)

NOTES:

1. INSULATOR MATERIAL: SEE PART NUMBER CODING
2. CONTACT MATERIAL: SEE PART NUMBER CODING
3. PLATING: SEE PART NUMBER CODING
4. OPERATING TEMPERATURE: SEE PART NUMBER CODING
5. PROCESSING TEMP: SEE PART NUMBER CODING
6. UL FLAMMABILITY RATING: 94V-0
7. OPERATING VOLTAGE: 700 VAC
8. CURRENT RATING: 3 AMP
9. CONTACT RESISTANCE: 30 MILLI OHMS MAX
10. INSULATION RESISTANCE: 5000 MEGA OHMS
11. DURABILITY: 500 CYCLES MINIMUM
12. CONNECTOR IDENTIFICATION: THE PART SHALL BE MARKED WITH A PART NUMBER AND LOT CODE
13. BOARD THICKNESS ACCOMMODATED:  $.062 \pm .008 [1.57 \pm 0.20]$
14. INSERTION FORCE: 16 OZ MAX PER CONTACT PAIR WHEN USING A  $.062 [1.57]$  TEST BLADE  
INTERNAL INSPECTION TO BE PER SULLINS WORK INSTRUCTION WI-8.6-03
15. WITHDRAWAL FORCE: 1 OZ MIN PER CONTACT PAIR USING  $.062 [1.57]$  TEST BLADE



UNLESS OTHERWISE SPECIFIED:  
DIMENSIONS ARE IN INCHES (MM)

TOLERANCES:  
ANGULAR:  $\pm 1^\circ$

DECIMALS  
.XX =  $\pm .02 [5]$   
.XXX =  $\pm .005 [13]$   
.XXXX =  $\pm .0005 [0.13]$

DRAWN	DATE	NAME
	5/31/2012	JH

THE INFORMATION HEREIN CONTAINS PROPRIETARY INFORMATION OF SULLINS ELECTRONICS AND IS NOT TO BE REPRODUCED, USED OR DISCLOSED TO OTHERS FOR ANY PURPOSE EXCEPT AS SPECIFICALLY AUTHORIZED IN WRITING BY AN OFFICER OF SULLINS ELECTRONICS.

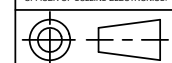

<b>SULLINS</b> CONNECTOR SOLUTIONS			
TITLE EDGECARD, .100 CC LP			
PART NUMBER MP - 100 - DP-1			
SIZE	CAGE CODE	DWG. NO.	REV
C	54453	C11935	C
SCALE: 3:1		SHEET 1 OF 3	

CUSTOMER COPY

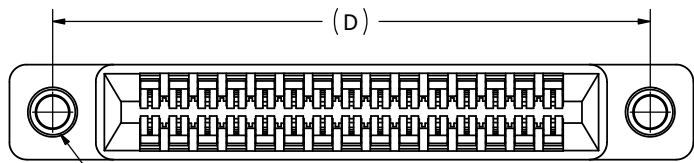

2X #4-40  
THREADED  
INSERTS

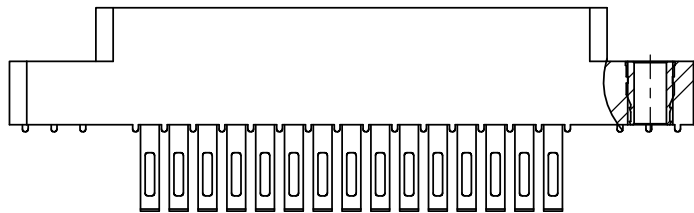

MP - 100 - DP-2

2X FLOATING BOBBIN  
Ø .116 [2.95]  
CLEARANCE HOLE  
FOR #4 SCREW

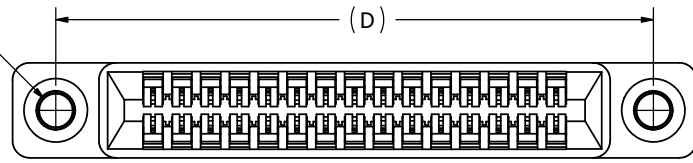

(.280 [7.11])

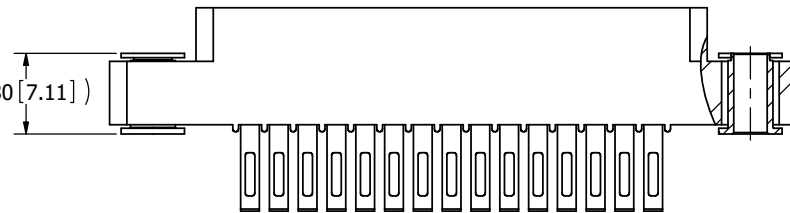

MP - 100 - DP-3

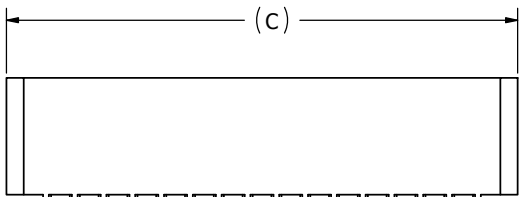
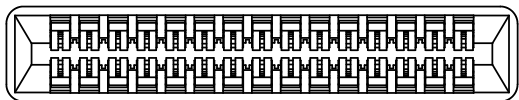

MP - 100 - DP-4

# CUSTOMER COPY



RoHS COMPLIANT

UNLESS OTHERWISE SPECIFIED:  
DIMENSIONS ARE IN INCHES (MM)

TOLERANCES:  
ANGULAR: ± 1°

DECIMALS  
.XX = ± .02 [5]  
.XXX = ± .005 [13]  
.XXXX = ± .0005 [13]

DRAWN	DATE	NAME
	5/31/2012	JH

THE INFORMATION HEREIN CONTAINS PROPRIETARY INFORMATION OF SULLINS ELECTRONICS AND IS NOT TO BE REPRODUCED, USED OR DISCLOSED TO OTHERS FOR ANY PURPOSE EXCEPT AS SPECIFICALLY AUTHORIZED IN WRITING BY AN OFFICER OF SULLINS ELECTRONICS.

<b>SULLINS</b> CONNECTOR SOLUTIONS			
TITLE EDGE CARD, .100 CC LP			
PART NUMBER MP - 100 - DP-			
SIZE C	CAGE CODE 54453	DWG. NO. C11935	REV C
SCALE: 3:1		SHEET 2 OF 3	

