

Recommended P.C. Board Layout
SCALE 6:1

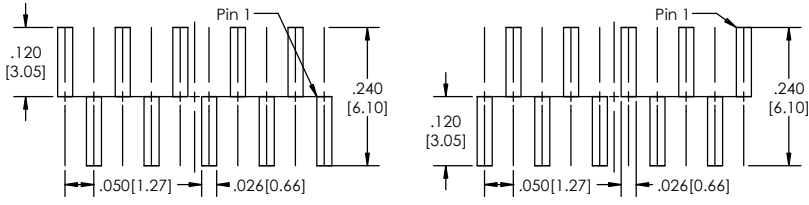

SINGLE (S)

SINGLE (M)

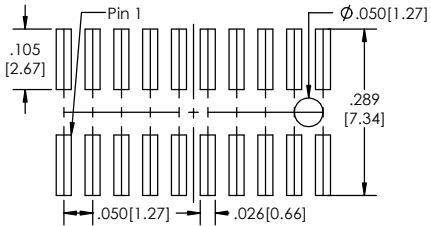

DOUBLE

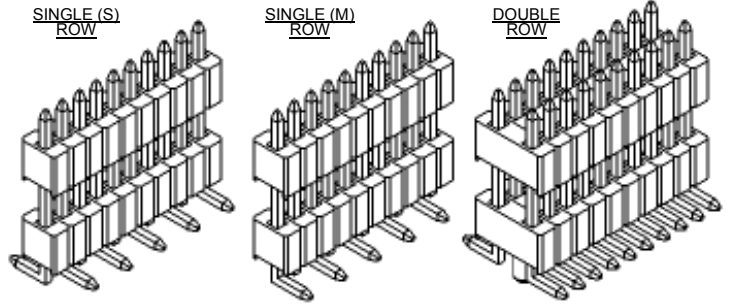
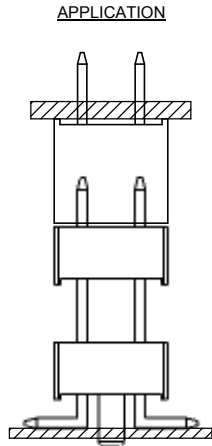

BSTCM-6 **XX** - **X** - **XXX** - **XX** - **XX** - **XXX** - **XXX** - **X** - **XX** - **X** - **XX** - **LF**
(A) (B) (C) (D) (E) (F) (G) (H) (I) (J) (K) (L)

- A. Pins Per Row
 - 1 through 40
- B. Row Specification
 - S= Single Row
 - D= Double Row
- C. Desired Post Height
 - Please specify
 - e.g. .200[5.08]= 200
 - If left blank: Post = Overall Length - Board Space
- D. Pin Options
 - See Pin Options below
- E. Plating Options
 - See Plating Options below
- F. Desired Board Space
 - Please Specify required space
 - e.g. .200[5.08]= 200
- G. Polarized Position
 - Leave blank if not needed
 - If required, specify empty pin position
 - e.g. 012 for Pin 12
- H. Footprint (Option only available for single row)
 - S= pin 1 left
 - M= pin 1 right
- I. Packing Information
 - TR= Tape and Reel
 - TB= Tube
- J. Pad
 - P= Plastic
 - O= No Pad
 - If left blank, packaging at MLE's discretion
 - Pad may be metal, mylar or plastic
- K. Alignment Pin Option (Only for Double Row)
 - AP= With
 - Leave blank if not needed
- L. Lead Free

Mates with:
LSSH
SMSS
SSHS

Specifications:
Current Rating: 1.0 Ampere
Insulation Resistance: 1000M Ohms Min.
Dielectric Withstanding: 300V AC
Contact Resistance: 20M Ohms Max.
Operation Temperature: -40°C to +105°C
Max. Process Temperature
Peak: 260°C up to 10 secs.
Process: 230°C up to 60 secs.
Wave: 260°C up to 6 secs.
Reflow: 260°C up to 10 secs.
Manual Solder: 350°C up to 5 secs.

Materials:
Contact Material: Phosphor Bronze
Insulator Material: Nylon 6T
Plating: Au or Sn over 50µ" (1.27) Ni

Pin Options		
Overall Length		
.330	8.38mm	04
.385	9.78mm	06
.435	11.05mm	08
.490	12.45mm	10
.505	12.83mm	12
.530	13.46mm	14
.585	14.86mm	16
.615	15.62mm	18
.685	17.40mm	20
.725	18.42mm	22
.785	19.94mm	24
.840	21.34mm	28

Post + Board Space must not exceed Overall Length

Plating options	
G	-10µ Gold on Contact Area/ Flash on Tail
T	-Matte Tin all Over
GT	-10µ Gold on Contact Area/ Matte Tin on Tail
H	-30µ Gold on Contact Area/ Matte Tin on Tail
F	-Gold Flash over Entire Pin
FT	- Gold Flash on Contact Area/ Matte Tin on Tail

Tails may be clipped to achieve specific dimensions.
Products cut to specific sizes are uncancelable/ nonreturnable.
Parts are subject to change without notice.

UNLESS OTHERWISE SPECIFIED:		NAME	DATE	
DIMENSIONS ARE IN INCHES		DRAWN	EOW 02/12/14	
TOLERANCES:		CHECKED	GWE 02/12/14	
ONE DECIMALS ±.100		ENG APPR.		
TWO DECIMAL ±.010		MFG APPR.		ADDRESS:
THREE DECIMAL ±.005				2533 Centennial Blvd.
FOUR DECIMAL ±.002				Jeffersonville, IN 47130
NEXT ASSY USED ON		FINISH		Phone: 812-670-4174
APPLICATION		DO NOT SCALE DRAWING		Fax: 812-670-4175
INTERPRET GEOMETRIC TOLERANCING PER:		MATERIAL		E-Mail: mle@mlelectronics.com
TITLE: BSTCM-6 SERIES		SIZE DWG. NO.		REV B
SCALE 8:1		SHEET 1 OF 1		

ROHS COMPLIANT

PROPRIETARY AND CONFIDENTIAL
THE INFORMATION CONTAINED IN THIS DRAWING IS THE SOLE PROPERTY OF Major League Electronics. ANY REPRODUCTION IN PART OR AS A WHOLE WITHOUT THE WRITTEN PERMISSION OF Major League Electronics IS PROHIBITED.

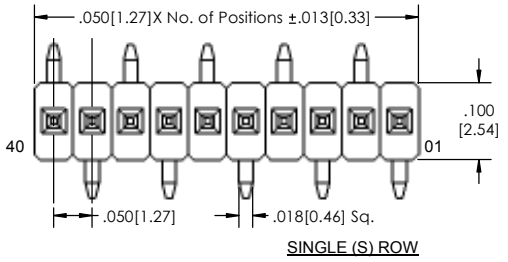
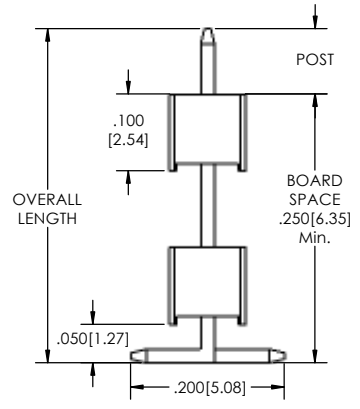

SINGLE (S) ROW

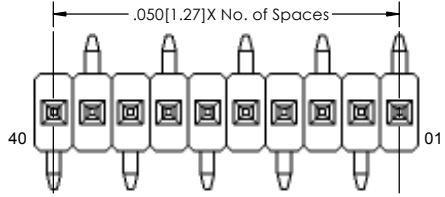

SINGLE (M) ROW

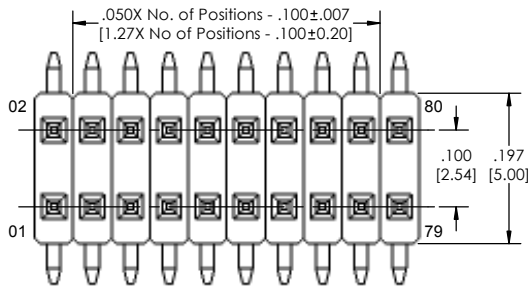

DOUBLE ROW

