

## Evaluating the HMC8342 GaAs MMIC $\times 2$ Active Frequency Multiplier, 22 GHz to 42 GHz Output

### FEATURES

Self contained board that includes the HMC8342 active frequency  $\times 2$  multiplier

Externally powered by a 5.0 V supply

Controlled by two  $-2.0$  V power supplies

### EVALUATION KIT CONTENTS

EV1HMC8342LS6 evaluation board

### EQUIPMENT NEEDED

Low noise, 5.0 V power supply

2 low noise, variable,  $-2.0$  V power supplies

Frequency generator

Spectrum analyzer

### ONLINE RESOURCES

[HMC8342 data sheet](#)

### GENERAL DESCRIPTION

The EV1HMC8342LS6 evaluates the performance of the HMC8342 microwave integrated circuit (MMIC), active frequency multiplier.

Figure 1 shows a photograph of the EV1HMC8342LS6. The EV1HMC8342LS6 contains the HMC8342 and two 2.92 mm K connectors. There is also a calibration path for use in calibrating out printed circuit board (PCB) trace delays at the RF input and RF output.

For full details on the HMC8342, see the HMC8342 data sheet. Consult this data sheet in conjunction with this user guide when using the EV1HMC8342LS6.

### EV1HMC8342LS6 EVALUATION BOARD PHOTOGRAPH

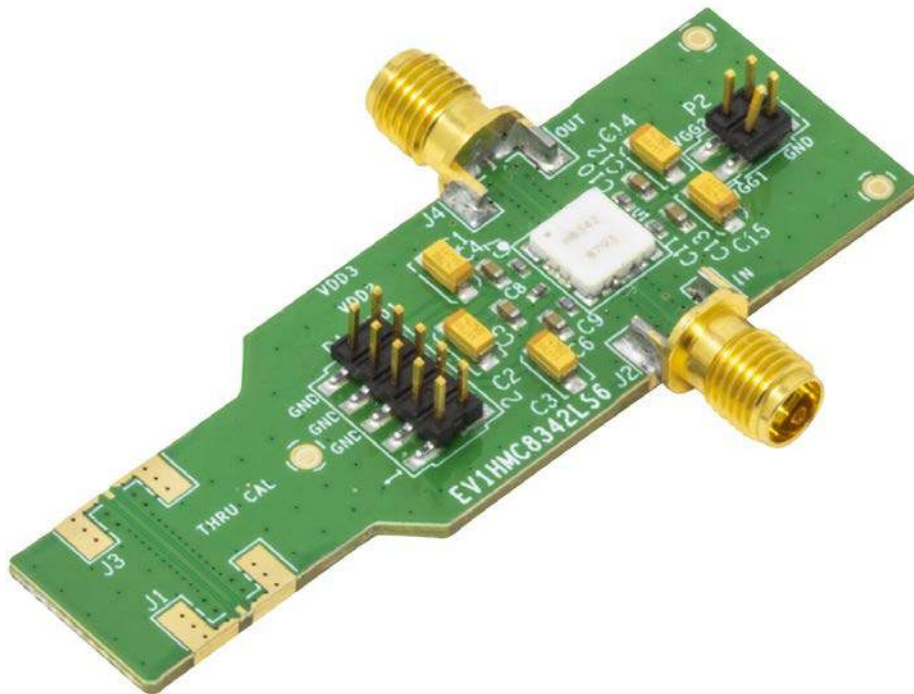

Figure 1.

28249-001

**TABLE OF CONTENTS**

Features .....	1	RF Input.....	4
Evaluation Kit Contents.....	1	RF Output.....	4
Equipment Needed.....	1	Calibration Path.....	4
Online Resources.....	1	Decoupling.....	4
General Description .....	1	Default Configuration .....	4
EV1HMC8342LS6 Evaluation Board Photograph.....	1	Evaluation and Test .....	5
Revision History .....	2	Evaluation Board Schematic and Artwork.....	6
Getting Started .....	3	Ordering Information.....	8
Evaluation Board Setup Procedure .....	3	Bill of Materials.....	8
Evaluation Board Hardware.....	4		
Power Supplies .....	4		

**REVISION HISTORY**

6/2021—Revision 0: Initial Version

## GETTING STARTED

### EVALUATION BOARD SETUP PROCEDURE

To configure the EV1HMC8342LS6 for the first time, perform the following steps:

1. Verify that the power supply used for the  $V_{DDx}$  supplies can output 5.0 V and 250 mA of current.
2. Set the power supply voltage to 0 V or disable its output to prevent damage.
3. Connect a 50  $\Omega$  RF cable capable of mating to the 2.92 mm K connector at the RF input, IN (J2), and torque this connection to 8 in/lb. Connect the other end of the cable to a signal generator or other RF signal to be multiplied.
4. Connect another 2.92 mm, K connectorized, 50  $\Omega$  RF cable to the RF output, OUT (J4), and torque this connection to 8 in/lb. Connect the other end of the cable to a spectrum analyzer.
5. Using hook clips, connect a 5.0 V power supply to the VDD1, VDD2, and VDD3 headers. The corresponding header pins for each supply are marked on the silkscreen. Individual power supply channels can be used for each VDDx header if desired. Otherwise, each VDDx header can be combined together in series using a shorting jumper and connected to a single 5.0 V power supply channel.
6. Two additional power supply channels are required for the gate bias voltages,  $V_{GG1}$  and  $V_{GG2}$ . Confirm both channels are set up for  $-2.0$  V, and then disable their outputs to avoid accidental damage.
7. Ensuring the  $V_{DDx}$  supplies are also still disabled, connect one of the negative supplies to the VGG2 header and the other to the VGG1 header of P2. The corresponding header pins are marked on the silkscreen.
8. Enable the output on both  $-2.0$  V  $V_{GGx}$  supplies.
9. Enable the output on the 5.0 V  $V_{DDx}$  supplies.
10. Verify that the total current draw from all of the  $V_{DDx}$  supplies at this point is approximately 50 mA.
11. Increase the  $V_{GG2}$  supply to  $-0.8$  V. Then, increase the  $V_{GG1}$  supply to  $-1.25$  V.  
For further detail on the correct biasing sequence, and information on how to fine tune the gate bias controls, see the [HMC8342](#) data sheet.
12. Verify that the output signal frequency is double the input frequency and the output power and isolation are within the specifications given in the HMC8342 data sheet. For an example output frequency, see Figure 2 in the Evaluation and Test section.
13. When powering down the device, ensure the  $V_{DDx}$  supplies are powered down before the  $V_{GGx}$  supplies to prevent excess current draw.

## EVALUATION BOARD HARDWARE

The EV1HMC8342LS6 schematic, silkscreen, and bill of materials are available in the Evaluation Board Schematic and Artwork section and the Ordering Information section. The Gerber fabrication files are available on the [HMC8342](#) product page.

### POWER SUPPLIES

The EV1HMC8342LS6 is powered by a 5.0 V dc (170 mA typical draw) power supply connected to the  $V_{DD1}$ ,  $V_{DD2}$ , and  $V_{DD3}$  pins on Header P1. The gate bias voltages,  $V_{GG1}$  and  $V_{GG2}$ , are applied to Header P2.

$V_{GG1}$  biases the multiplier stage, and  $V_{GG2}$  biases the amplification stage.

Ensure the  $V_{GGx}$  gate voltages are applied before the  $V_{DDx}$  supply voltages. Otherwise, the device can be damaged.

For additional details on the active multiplier circuitry, consult the HMC8342 data sheet.

### RF INPUT

The EV1HMC8342LS6 has one 50  $\Omega$  RF input port, IN (J2). IN is a single-ended input that operates from 11 GHz to 21 GHz. The maximum input drive level must not exceed 10 dBm.

### RF OUTPUT

The EV1HMC8342LS6 has one 50  $\Omega$  RF output port, OUT (J4). J4 is a populated 2.92 mm K connector that is rated for up to 40 GHz when used with a 2.92 mm, K connectorized cable assembly.

Operation at output frequencies greater than 42 GHz do not cause damage to the main device or the EV1HMC8342LS6, but it is important to note that the output power and isolation may be outside of data sheet specification. Refer to the typical performance characteristics plots in the HMC8342LS6 data sheet for information on the losses expected outside of the specified frequency range.

### CALIBRATION PATH

The EV1HMC8342LS6 has an on-board calibration path. To use the calibration path, the J1 and J3 connectors must each be populated with a 2.92 mm K connector. The electrical length of the calibration path is the same as the IN and OUT traces, but not including the length of the HMC8342.

The RF connections to the board (J1, J2, J3, and J4) all use the same footprint.

### DECOUPLING

The EV1HMC8342LS6 by default comes with the recommended decoupling capacitors on its supply pins as per the HMC8342 data sheet.

### DEFAULT CONFIGURATION

All components necessary for  $\times 2$  multiplication and amplification of RF signals are inserted on the EV1HMC8342LS6.

## EVALUATION AND TEST

To configure the EV1HMC8342LS6 for the first time, follow Step 1 through Step 11 in the Evaluation Board Setup Procedure section. To evaluate and test the performance of the EV1HMC8342LS6, perform the following steps:

1. Connect a 15 GHz, 5 dBm signal from a signal generator to IN (J2). Observe OUT (J4) on a spectrum analyzer centered at 32 GHz. Refer to Figure 2.
2. Center the spectrum analyzer to 30 GHz and check the signal power. Refer to Figure 3. The difference in power between this signal and the signal from Step 1 is given as the fundamental input isolation.
3. Similarly, check the third and further input harmonic suppressions at the output as required by comparing the output power at these harmonics to the output signal at double the fundamental input from Step 1.
4.  $V_{GG2} = -0.8$  V and  $V_{GG1} = -1.25$  V are typical bias values that result in a  $V_{DDX}$  supply of between 160 mA and 190 mA for a 5 dBm input drive level. Observe that the supply current, the output power from Step 1, and the isolation from Step 2 varies if  $V_{GG1}$  and  $V_{GG2}$  are adjusted.
5. The exact gate bias voltages for optimum output power and isolation vary based on the application and input signal characteristics. However, it is possible to alternate between adjusting  $V_{GG1}$  and  $V_{GG2}$  to achieve the desired performance, ensuring the absolute maximum ratings from the HMC8342 data sheet are not exceeded.

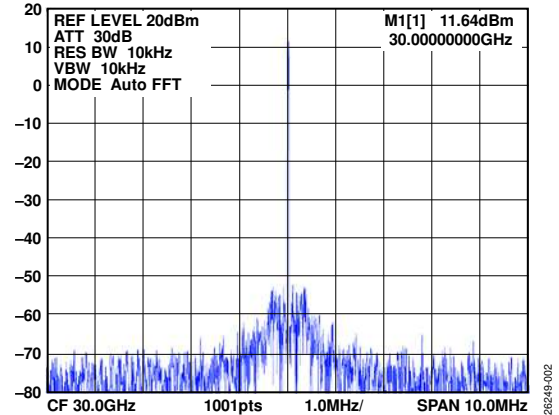

Figure 2. EV1HMC8342LS6 OUT (J4) RF Output, Input Frequency = 15 GHz, Input Power = 5 dBm,  $V_{GG2} = -0.8$  V,  $V_{GG1} = -1.25$  V, Includes Insertion Loss of the RF Cable

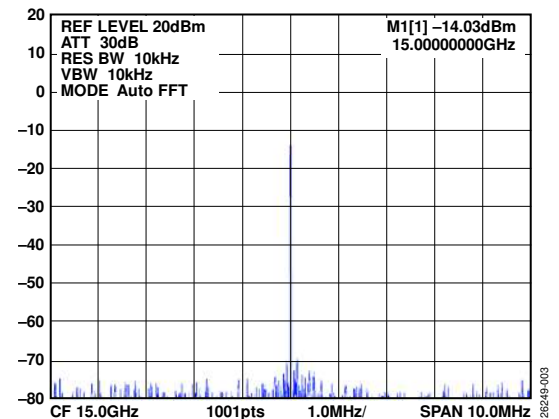

Figure 3. EV1HMC8342LS6 OUT (J4) Isolation, Input Frequency = 15 GHz, Input Power = 5 dBm,  $V_{GG2} = -0.8$  V,  $V_{GG1} = -1.25$  V, Includes Insertion Loss of the RF Cable

EVALUATION BOARD SCHEMATIC AND ARTWORK

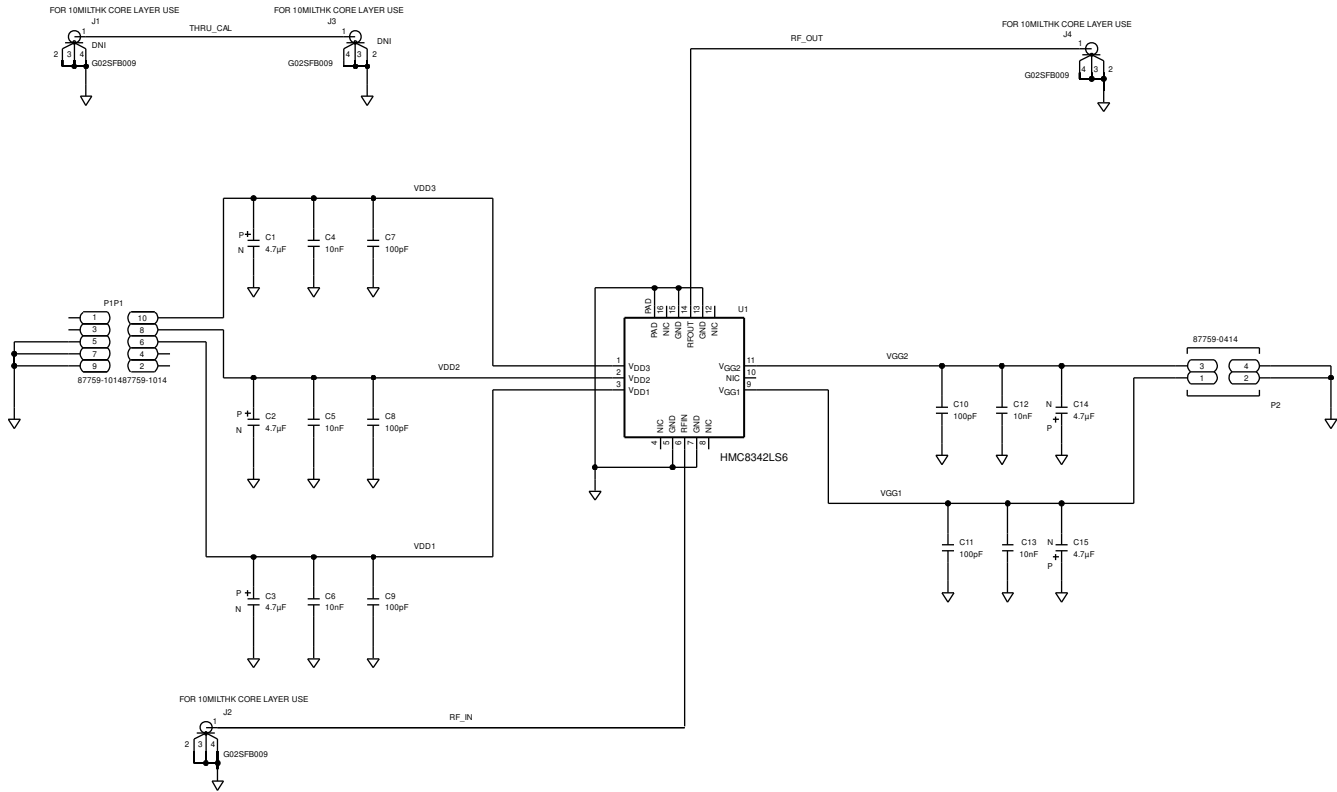

Figure 4. EV1HMC8342LS6 Schematic

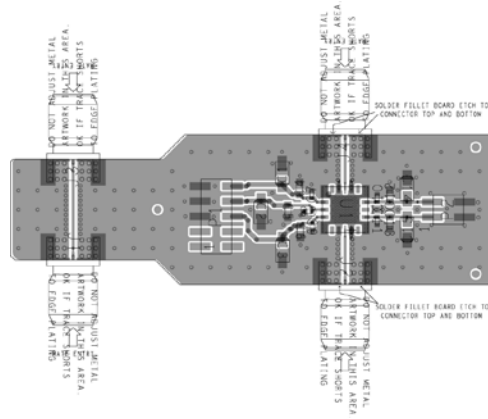

Figure 5. EV1HMC8342LS6 Silk Screen and Metal 1, Top Side

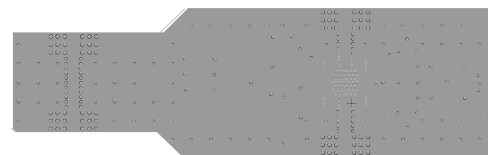

Figure 6. EV1HMC8342LS6 Metal 2, Ground

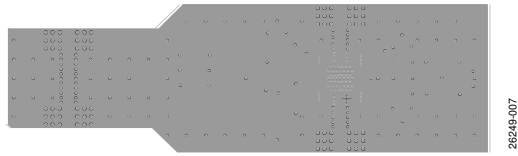

Figure 7. EV1HMC8342LS6 Metal 3, Ground

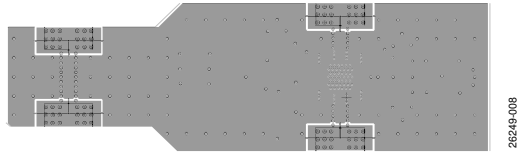

Figure 8. EV1HMC8342LS6 Metal 4, Backside

## ORDERING INFORMATION

### BILL OF MATERIALS

Table 1. Bill of Materials

Reference Designator	Description	Value	Manufacturer	Part Number
C1, C2, C3, C14, C15	Capacitors, tantalum, 10%, 3216	4.7 $\mu$ F	AVX	TAJA475K020RNJ
C7, C8, C9, C10, C11	Capacitors, ceramic, 5%, C0G, 0402	100 pF	TDK	C1005NP01H101J050BA
C4, C5, C6, C12, C13	Capacitors, ceramic, 10%, X7R, 0603	10 nF	Murata	GCM188R72A103KA37J
J2, J4	2.92 mm, K connectorized coaxial edge mount jack	Not applicable	Gigalane	G025FB009
P1	10-position male header, unshrouded, double row, 2 mm pitch	Not applicable	Molex	87759-1014
P2	4-position male header, unshrouded, double row, 2 mm pitch	Not applicable	Molex	87759-0414
U1	GaAs, MMIC, x2 active frequency multiplier, 22 GHz to 42 GHz output	Not applicable	Analog Devices, Inc.	<a href="#">HMC8342</a>



#### ESD Caution

**ESD (electrostatic discharge) sensitive device.** Charged devices and circuit boards can discharge without detection. Although this product features patented or proprietary protection circuitry, damage may occur on devices subjected to high energy ESD. Therefore, proper ESD precautions should be taken to avoid performance degradation or loss of functionality.

**Legal Terms and Conditions** By using the evaluation board discussed herein (together with any tools, components documentation or support materials, the "Evaluation Board"), you are agreeing to be bound by the terms and conditions set forth below ("Agreement") unless you have purchased the Evaluation Board, in which case the Analog Devices Standard Terms and Conditions of Sale shall govern. Do not use the Evaluation Board until you have read and agreed to the Agreement. Your use of the Evaluation Board shall signify your acceptance of the Agreement. This Agreement is made by and between you ("Customer") and Analog Devices, Inc. ("ADI"), with its principal place of business at One Technology Way, Norwood, MA 02062, USA. Subject to the terms and conditions of the Agreement, ADI hereby grants to Customer a free, limited, personal, temporary, non-exclusive, non-sublicensable, non-transferable license to use the Evaluation Board FOR EVALUATION PURPOSES ONLY. Customer understands and agrees that the Evaluation Board is provided for the sole and exclusive purpose referenced above and agrees not to use the Evaluation Board for any other purpose. Furthermore, the license granted is expressly made subject to the following additional limitations: Customer shall not (i) rent, lease, display, sell, transfer, assign, sublicense, or distribute the Evaluation Board; and (ii) permit any Third Party to access the Evaluation Board. as used herein, the term "Third Party" includes any entity other than ADI, Customer, their employees, affiliates and in-house consultants. The Evaluation Board is NOT sold to Customer; all rights not expressly granted herein, including ownership of the Evaluation Board, are reserved by ADI. CONFIDENTIALITY. This Agreement and the Evaluation Board shall all be considered the confidential and proprietary information of ADI. Customer may not disclose or transfer any portion of the Evaluation Board to any other party for any reason. Upon discontinuation of use of the Evaluation Board or termination of this Agreement, Customer agrees to promptly return the Evaluation Board to ADI. ADDITIONAL RESTRICTIONS. Customer may not disassemble, decompile or reverse engineer chips on the Evaluation Board. Customer shall inform ADI of any occurred damages or any modifications or alterations it makes to the Evaluation Board, including but not limited to soldering or any other activity that affects the material content of the Evaluation Board. Modifications to the Evaluation Board must comply with applicable law, including but not limited to the RoHS Directive. TERMINATION. ADI may terminate this Agreement at any time upon giving written notice to Customer. Customer agrees to return to ADI the Evaluation Board at that time. LIMITATION OF LIABILITY. THE EVALUATION BOARD PROVIDED HEREUNDER IS PROVIDED "AS IS" AND ADI MAKES NO WARRANTIES OR REPRESENTATIONS OF ANY KIND WITH RESPECT TO IT. ADI SPECIFICALLY DISCLAIMS ANY REPRESENTATIONS, ENDORSEMENTS, GUARANTEES, OR WARRANTIES, EXPRESS OR IMPLIED, RELATED TO THE EVALUATION BOARD INCLUDING, BUT NOT LIMITED TO, THE IMPLIED WARRANTY OF MERCHANTABILITY, TITLE, FITNESS FOR A PARTICULAR PURPOSE OR NON-INFRINGEMENT OF INTELLECTUAL PROPERTY RIGHTS. IN NO EVENT WILL ADI AND ITS LICENSORS BE LIABLE FOR ANY INCIDENTAL, SPECIAL, INDIRECT, OR CONSEQUENTIAL DAMAGES RESULTING FROM CUSTOMER'S POSSESSION OR USE OF THE EVALUATION BOARD, INCLUDING BUT NOT LIMITED TO LOST PROFITS, DELAY COSTS, LABOR COSTS OR LOSS OF GOODWILL. ADI'S TOTAL LIABILITY FROM ANY AND ALL CAUSES SHALL BE LIMITED TO THE AMOUNT OF ONE HUNDRED US DOLLARS (\$100.00). EXPORT. Customer agrees that it will not directly or indirectly export the Evaluation Board to another country, and that it will comply with all applicable United States federal laws and regulations relating to exports. GOVERNING LAW. This Agreement shall be governed by and construed in accordance with the substantive laws of the Commonwealth of Massachusetts (excluding conflict of law rules). Any legal action regarding this Agreement will be heard in the state or federal courts having jurisdiction in Suffolk County, Massachusetts, and Customer hereby submits to the personal jurisdiction and venue of such courts. The United Nations Convention on Contracts for the International Sale of Goods shall not apply to this Agreement and is expressly disclaimed.