

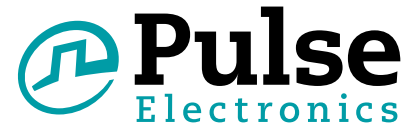





THT Power Inductors

Toroid - Bare Coil Series



-  Low cost solutions for VRM, Game Console and Consumer applications
-  **Current Range:** up to 48A
-  **Inductance Range:** 5 μ H to 12 μ H
-  **Frequency Range:** up to 1MHz
-  Custom configurations are possible

Electrical Specifications @ 25°C — Operating Temperature -40°C to +130°C

Part* Number	Reference Data				Build	Design Calculation Data					
	Inductance @ Irated (μ H TYP)	Irated 2 (A)	DCR m Ω MAX)	Inductance @OADC (μ H \pm 20%)		H1	K1	K2	K3	K4	K5
PG0122NL	0.48	30.5	2.0	0.60	Material 18 T60-18 3x18GA,4T	1.3	134	8.2E-03	1.2	2.3	47
PG0123NL	0.49	48.0	0.85	0.86	Material 18 T60-18 3x17GA,5T	1.7	107	8.2E-03	1.2	2.3	47
PA0690NL	0.50	22.5	1.5	0.88	Material 52 T44-52 1x16GA,5T	2.4	202	3.1E-03	1.3	2.1	80
PA0235LNL	0.67	22.5	2.6	0.86	Material 8/90 T50-8/90 1x17GA,7T	2.8	128	6.4E-03	1.1	2.4	64
PA0689NL	0.80	21.5	2.0	1.70	Material 52 T44-52 1x16GA,7T	3.3	144	3.1E-03	1.3	2.1	80
PA0430LNL	0.86	37.5	1.6	1.96	Material 52 T68-52 2x16GA,7T	2.1	80	8.8E-03	1.3	2.1	42
P1967LNL	0.93	23.8	3.8	1.44	Material 52 T68-52 1x16GA,6T	1.8	93	8.8E-03	1.3	2.1	42
PG0116NL	1.02	14.9	4.2	1.70	Material 52 T44-52 1x18GA,7T	3.3	144	3.1E-03	1.3	2.1	80
PA0489LNL	1.05	19.0	2.7	2.24	Material 52 T44-52 1x16GA,8T	3.8	126	3.1E-03	1.3	2.1	80
PG0112NL	1.10	13.8	7.0	2.50	Material 52 T50-52 3x22GA,9T	3.6	99	4.2E-03	1.3	2.1	64
P1715LNL	1.81	14.3	5.0	3.50	Material 52 T44-52 1x17GA,10T	4.7	101	3.1E-03	1.3	2.1	80
PA0431LNL	3.22	20.5	5.5	7.80	Material 52 T68-52 1x16GA,14T	4.2	40	8.8E-03	1.3	2.1	42
PA0432LNL	5.00	20.5	7.5	12.10	Material 52 T80-52 1x16GA,17T	4.2	25	1.4E-02	1.3	2.1	32

*NOTE: The "NL" suffix indicates a RoHS-compliant part number. Non-NL suffixed parts are not necessarily RoHS compliant, but are electrically and mechanically equivalent to NL versions. If a part number does not have the "NL" suffix, but an RoHS compliant version is required, please contact Pulse for availability.

Notes from Tables

1. The temperature of the component (ambient plus temperature rise) must be within the stated operating temperature range.
2. The rated current is the current that will cause the temperature of the part to increase by 40°C with 3.6 volt * μsec across the component and 100LFM of forced air cooling.
3. To determine the inductance of a component at a different operating current, use the graph below for the appropriate material type.
4. In high volt-μsec applications additional heating may occur due to core losses in the inductor which may necessitate derating the current in order to limit the temperature rise of the component. In order to determine the approximate total losses (or temperature rise) of the component in particular applications, the following formulas can be used.

Estimated Temperature Rise:

$$Trise = AirFlowFactor * K5 * (Coreloss(W) + Copperloss(W))^{.855} (C)$$

Where

AirFlowFactor = 1 (no air flow), 0.53 (100LFM), 0.39 (200LFM), 0.35 (300LFM), 0.30 (400LFM)

$$CopperLoss = Irms^2 * DCR_Typical (m\Omega) / 1000$$

$$DCR_Typical (mW) = .85 * DCR_Max(from table)$$

$$CoreLoss = K2 * (Freq_kHz)^{K3} * (\Delta B/2000)^{K4}$$

$$\Delta B = K1 * Volt-\mu sec$$

Dimensions (in/mm)

Part No.	A	B	C	D	E	F
PG012Z	.807 20,50	.374 9,50	.748 19,00	.126 3,20	.098 2,50	.354 9,00
PG012Z	.807w 20,50	.413 10,50	.748 19,00	.126 3,20	.106 2,68	.354 9,00
PA0690	.625 15,90	.345 8,80	.545 13,80	.129 3,30	.052 1,30	.300 7,60
PA0235L	N/A	.400 10,20	.660 16,80	.150 3,80	.050 1,30	.300 7,60
PA0689	.625 15,90	.345 8,80	.545 13,80	.129 3,30	.052 1,30	.300 7,60
PA0430L	.874 22,20	.374 9,50	N/A	.250 6,40	N/A	.245 6,20
P1967L	.906 23,00	.492 12,50	.906 23,00	.130 3,30	.055 1,40	.300 7,60
PG0116	.571 14,50	.276 7,00	.571 14,50	.126 3,20	.041 1,05	.276 7,00
PA0489L	.604 15,30	.323 8,20	.556 14,10	.157 4,00	.048 1,20	.250 6,40
PG011Z	.630 16,00	.374 9,50	.630 16,00	.140 3,60	.063 1,60	.295 7,50
P1715L	.610 15,50	.325 8,30	N/A	.130 3,30	.045 1,10	.300 7,60
PA0431L	.874 22,20	.374 9,50	N/A	.250 6,40	.054 1,40	.240 6,10
PA0432L	.980 24,90	.440 11,20	.980 24,90	.250 6,40	.054 1,40	.310 7,90

Mechanical

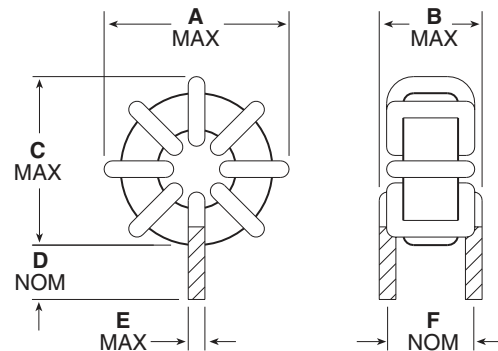

Schematic

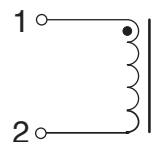

Dimensions: $\frac{\text{Inches}}{\text{mm}}$

Inductance vs Magnetizing Force

