

### DESCRIPTION

The EV2019-N-00A is an evaluation board for the MP2019 and MPQ2019, a low linear regulator that supplies power to systems with high voltage batteries.

MP2019 and MPQ2019 includes a wide 2.5V to 40V input range, low dropout voltage and low quiescent supply current. The low quiescent current and low dropout voltage allow operations at extremely low power levels. Therefore, the MP2019 and MPQ2019 is ideal for the low power microcontrollers and the battery-powered equipments.

The EV2019-N-00A is a fully assembled and tested evaluation board. It generates a +5V output voltage at load current up to 300mA from a 6V to 40V input range.

### ELECTRICAL SPECIFICATIONS

Parameter	Symbol	Value	Units
Input Voltage	$V_{IN}$	6 – 40	V
Output Voltage	$V_{OUT}$	5	V
Output Current	$I_{OUT}$	300	mA

### FEATURES

- 6V to 40V Input Range
- 10 $\mu$ A Quiescent Supply Current
- 300mA specified current
- 420mV Dropout at 300mA Load
- Output  $\pm$ 2% Accuracy
- Specified current limit
- Thermal Shutdown
- -40°C to +125°C Specified Junction Temperature Range
- Includes SOIC8-EP Package

### APPLICATIONS

- Industrial/Automotive Applications
- Portable/Battery-Powered Equipment
- Ultra low power Microcontrollers
- Cellular Handsets
- Medical Imaging

All MPS parts are lead-free and adhere to the RoHS directive. For MPS green status, please visit MPS website under Quality Assurance. "MPS" and "The Future of Analog IC Technology" are Registered Trademarks of Monolithic Power Systems, Inc.

### EV2019-N-00A EVALUATION BOARD



(L x W x H) 2.5" x 2.5" x 0.4"  
(6.35cm x 6.35cm x 1.0cm)

Board Number	MPS IC Number
EV2019-N-00A	MPQ2019GN

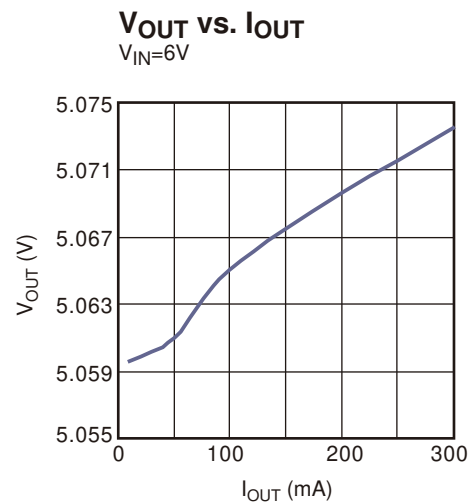

## EVALUATION BOARD SCHEMATIC

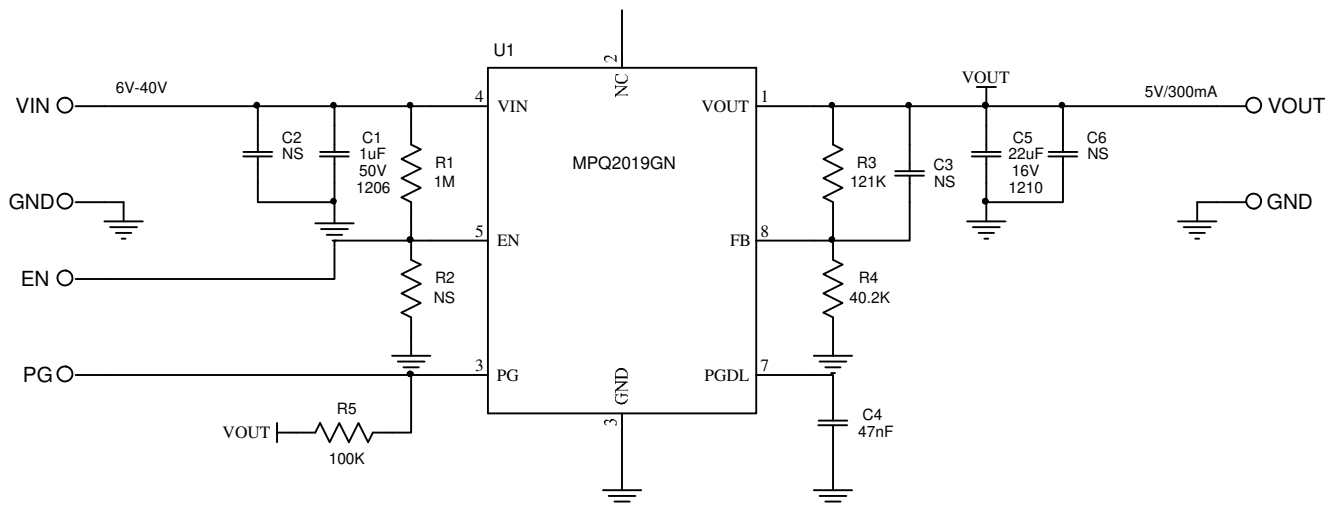

## EV2019-N-00A BILL OF MATERIALS

Qty	RefDes	Value	Description	Package	Manufacturer	Manufacturer_P/N
1	C1	1uF	Ceramic Cap, 50V, X7R	1206	Murata	GRM31CR71H225KA88L
3	C2, C3, C6	NS				
1	C4	47nF	Ceramic Cap, 50V, X7R	0603	Murata	GRM188R71H473KA61D
1	C5	22uF	Ceramic Cap, 16V, X7R	1210	Murata	GRM32ER71C226KEA8L
1	R1	1M	Film Res,5%	0603	Yageo	RC0603JR-071ML
1	R2	NS				
1	R3	121K	Film Res,1%	0603	Yageo	RC0603FR-07121KL
1	R4	40.2K	Film Res,1%	0603	Yageo	RC0603JR-0740K2L
1	R5	100K	Film Res,1%	0603	Yageo	RC0603FR-07100KL
1	U1		Linear Regulator	SOIC8E	MPS	MPQ2019GN
4	VIN, GND, GND, VOUT		2.0 Golden Pin		HZ	
3	PG, GND, EN		2.54mm Test Pin		Any	

## EVB TEST RESULTS

Performance waveforms are tested on the evaluation board.

$V_{OUT} = 5V$ ,  $T_A = 25^\circ C$ , unless otherwise noted.

**Ground Current vs. Load Current**  
 $V_{IN}=6V$

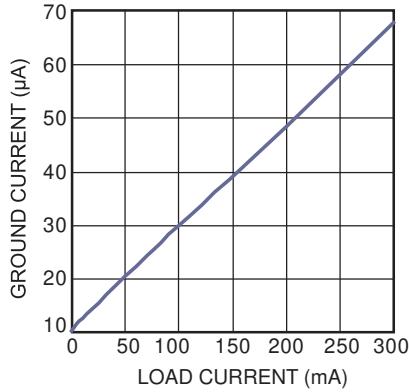

**Ground Current vs. VIN**  
 $I_{OUT}=0mA$

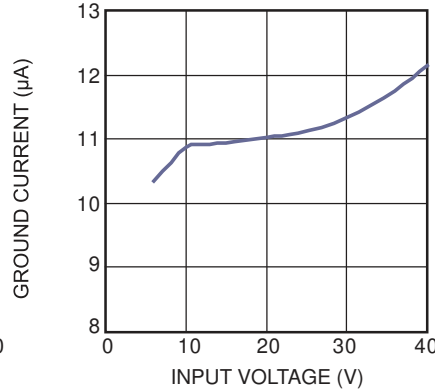

**Dropout Voltage vs. Load Current**

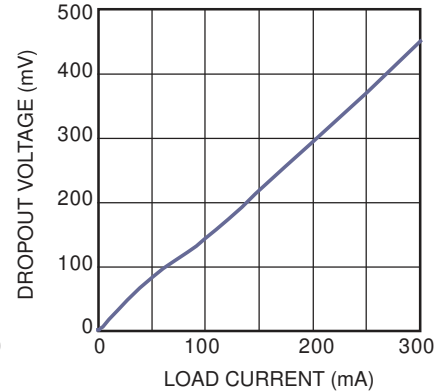

**VOUT vs. IOUT**  
 $V_{IN}=6V$

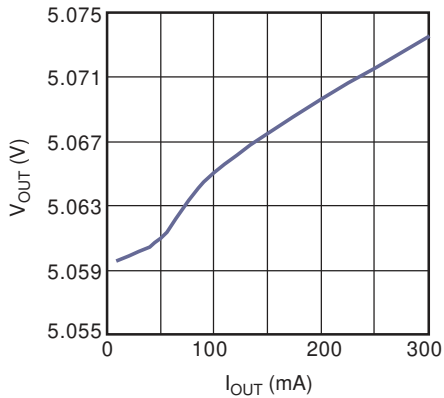

**VOUT vs. VIN**

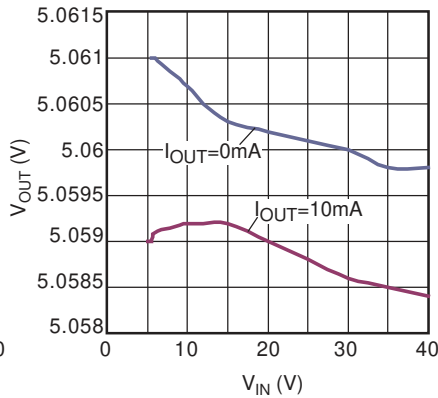

**PSRR vs. Frequency**

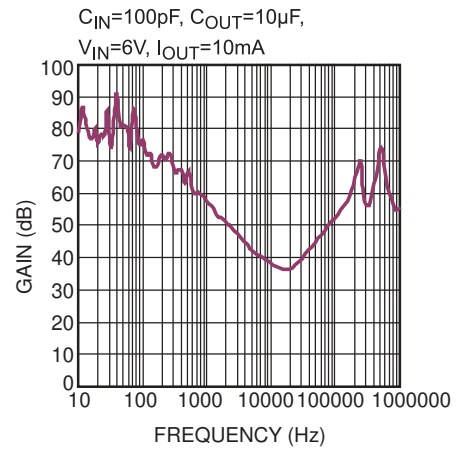

**EVB TEST RESULTS** *(continued)*

Performance waveforms are tested on the evaluation board.

$V_{OUT} = 5V$ ,  $T_A = 25^\circ C$ , unless otherwise noted.

**Load Transient**

$V_{IN} = 12V$ ,  $I_{OUT} = 300mA$

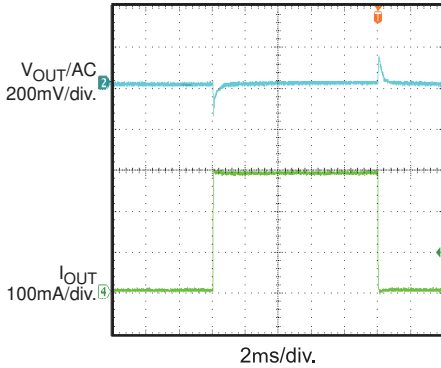

**Line Transient**

$V_{IN} = 6V-7V$ ,  $I_{OUT} = 300mA$

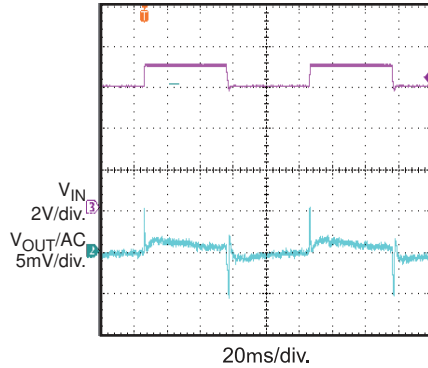

**Startup through VIN**

$V_{IN} = 12V$ ,  $I_{OUT} = 300mA$

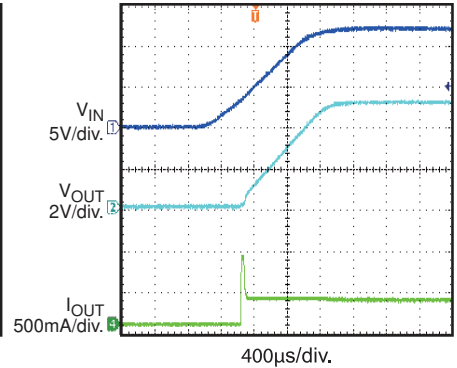

**Shutdown through VIN**

$V_{IN} = 12V$ ,  $I_{OUT} = 300mA$

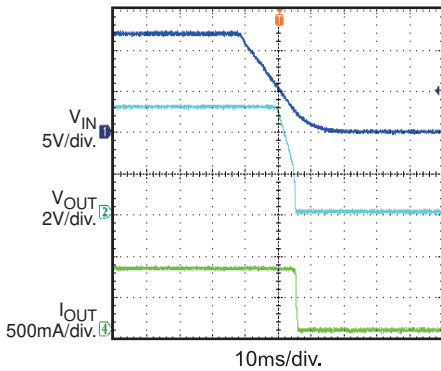

**Short Circuit Entry**

$V_{IN} = 12V$ ,  
 $I_{OUT} = 0mA$  to short circuit

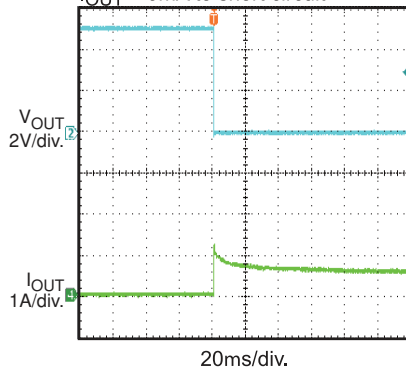

**Short Circuit Recovery**

$V_{IN} = 12V$ ,  
short circuit to  $I_{OUT} = 0mA$

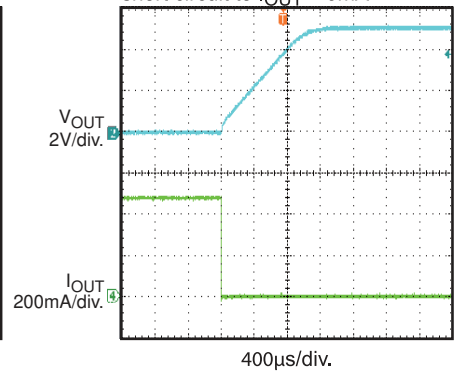

**Short Circuit Steady State**

$V_{IN} = 12V$

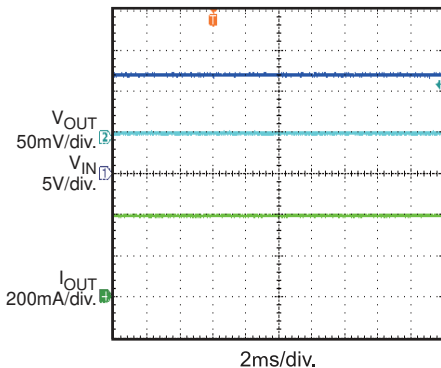

## PRINTED CIRCUIT BOARD LAYOUT

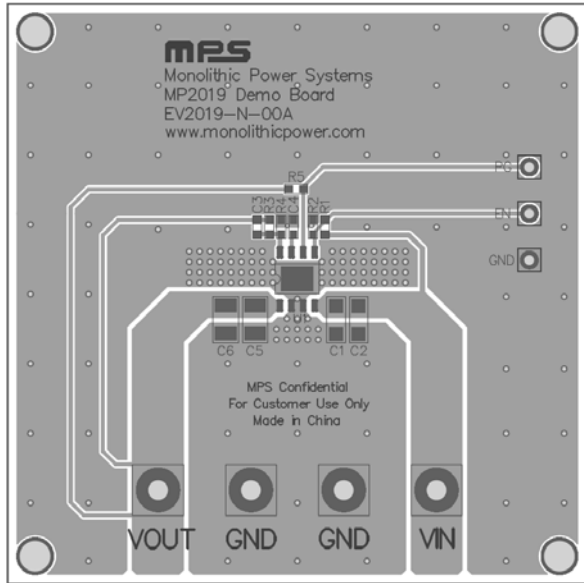

**Figure 1—Top Silk Layer & Top Layer**

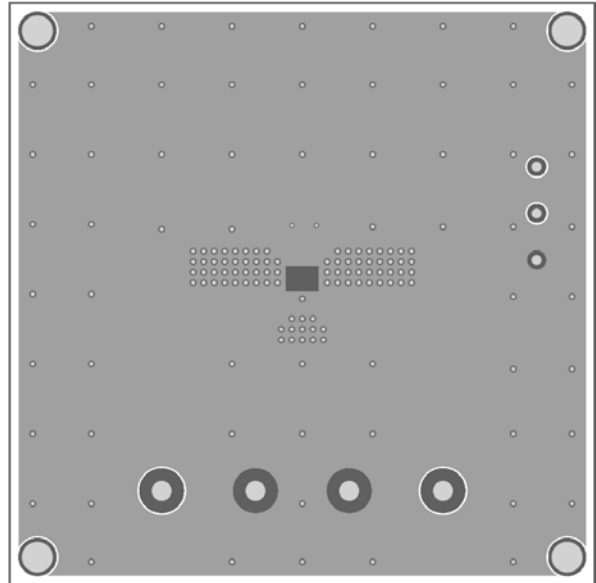

**Figure 2—Bottom Layer**

## QUICK START GUIDE

1. Connect the positive and negative terminals of the load to the VOUT and GND pins, respectively.
2. Preset the power supply output between 6V and 40V, and then turn it off.
3. Connect the positive and negative terminals of the power supply output to the VIN and GND pins, respectively.
4. Turn the power supply on. The MP2019 and MPQ2019 will automatically startup.

**NOTICE:** The information in this document is subject to change without notice. Users should warrant and guarantee that third party Intellectual Property rights are not infringed upon when integrating MPS products into any application. MPS will not assume any legal responsibility for any said applications.