



**CMOSIS / AWAIBA**

is now

# Member of the ams Group

The technical content of this CMOSIS / AWAIBA document is still valid.

**Contact information:**

**Headquarters:**

ams AG

Tobelbaderstrasse 30

8141 Premstaetten, Austria

Tel: +43 (0) 3136 500 0

e-Mail: [ams\\_sales@ams.com](mailto:ams_sales@ams.com)

Please visit our website at [www.ams.com](http://www.ams.com)



**CMV300 0.3Mp machine vision CMOS image sensors**

# **Evaluation System Manual**

**Change record**

<b>Issue</b>	<b>Date</b>	<b>Modification</b>
1.0	02/08/2012	Origination
2.0	10/09/2014	Update for software version 2.0 Removed “confidential” in footer

## Table of Contents

<b>1</b>	<b>System description .....</b>	<b>4</b>
1.1	Overview .....	4
1.2	Block diagram .....	4
1.3	Contents of the test system.....	4
1.4	CMV300 system .....	5
1.4.1	Lens holder .....	5
1.4.2	Power supply .....	5
1.4.3	LED's .....	5
1.5	FPGA .....	5
1.6	CameraLink Interface.....	6
<b>2</b>	<b>Frame grabber and PC.....</b>	<b>7</b>
<b>3</b>	<b>Installing the system .....</b>	<b>8</b>
<b>4</b>	<b>Running the system.....</b>	<b>9</b>
4.1	Starting the system.....	9
4.2	Software overview .....	9
4.3	Software details.....	10
4.3.1	Control area.....	10
4.3.2	Register settings area .....	10
4.3.3	Image area .....	12
4.3.4	Image statistics area .....	13
4.3.4.1	Image statistics in ROI mode.....	13
4.3.5	Software startup.....	16
4.3.6	Errors.....	16
4.4	Change frequency.....	17

## 1 SYSTEM DESCRIPTION

### 1.1 OVERVIEW

The purpose of this document is to give an overview of the test system which for the CMV300 machine vision image sensor produced by CMOSIS. This test system can be used for testing and verifying the operation of the CMV300 image sensor.

### 1.2 BLOCK DIAGRAM

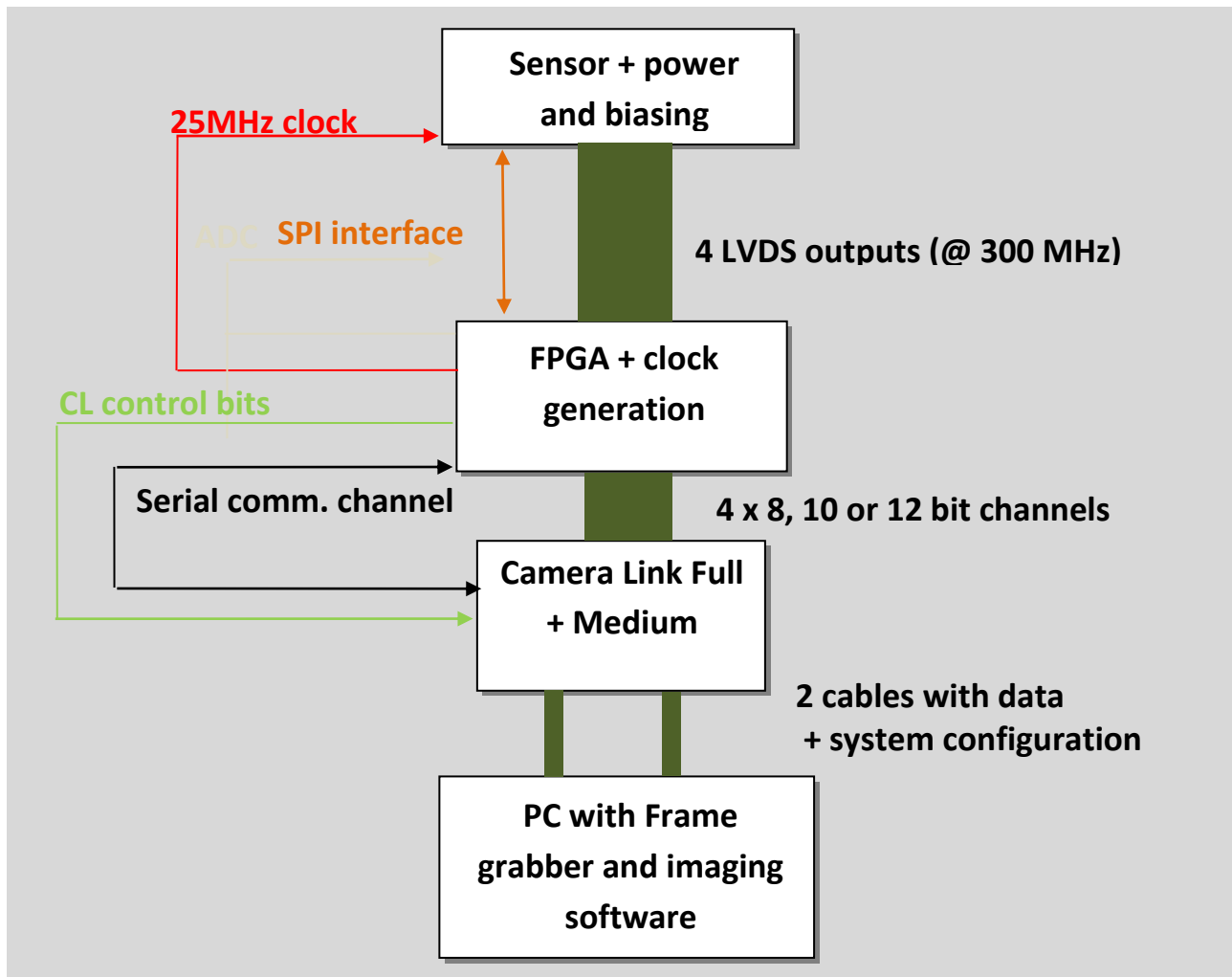

The block diagram above displays the different parts of the CMV300 test system. The three upper blocks are implemented on one PCB.

The fourth block is a standard third party frame grabber card which plugs into a PC's PCI Express bus (NI 1433). For this frame grabber and the PCB dedicated software has been developed in a LabVIEW environment.

### 1.3 CONTENTS OF THE TEST SYSTEM

The following components should be present when the CMV300 test system is delivered.

- 1 x CMV300 aluminium case with PCB + CMV300 sensor
- 2 x lens c-mount spacers (5mm and 10mm)
- 2 x CameraLink cables MDR – SDR (2m)

- Camera tripod
- NI PCI1433 frame grabber card (inside PC)
- Lenovo ThinkCentre mini tower model + software + keyboard + mouse
- CD with documentation and software

## 1.4 CMV300 SYSTEM

### 1.4.1 LENS HOLDER

The CMV300 casing is equipped with a C-mount lens holder/spacer. On this lens holder, off-the-shelf C-mount lenses can be fitted. The CMV300 image sensor requires 2/3 inch or bigger C-mount lenses!

### 1.4.2 POWER SUPPLY

The kit comes with a power supply (110VAC~240VAC input; 5VDC/2.5A output), with socket adapters for different countries.

The outside shield on the output pin of the supply is 0V, the internal pin is +5VDC (see fig1). Do not switch polarity of this or you will damage the board.

Insert the output pin into the foreseen plug on the case.

### 1.4.3 LED's

The casing has 4 LED's which will give some info about the system.

- LED1 is the power LED. It will light up when power is applied.
- LED2 will light up when the FPGA has correctly loaded it's firmware.
- LED3 will light up during the integration time (INTE1)
- LED4 will light up during the integration time (INTE2)

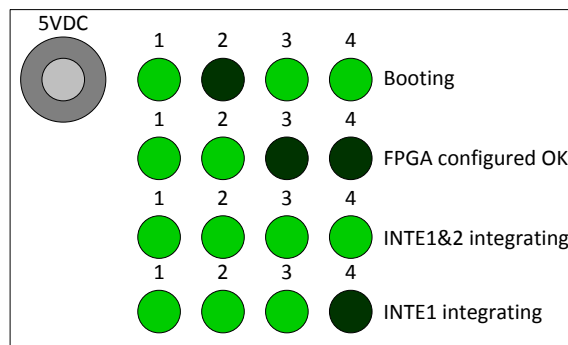

## 1.5 FPGA

The FPGA has 6 important roles in the test system:

1. Accept the LVDS data from the sensor (4 data channels @ 300Mbps, 1 LVDS DDR clock channel @ 150MHz and 1 control channel @ 300Mbps)
2. Generate the necessary driving signals for the sensor
3. Generate the clocks needed by the sensor and CameraLink interface
4. Communicate with the sensor over the SPI interface
5. Communicate with the PC over the serial interface of the CameraLink
6. Prepare the data for the CameraLink interface
7. Send the data to the CameraLink interface together with the control bits and clocks

Taking the requirements above into account, we have chosen Xilinx Virtex5 FPGA for our test system. All functionality described in the requirements above is programmed into the FPGA. Communication between the PC and FPGA is possible using the serial channel of the CameraLink interface.

## 1.6 CAMERALINK INTERFACE

The interface between the test board (camera) and the PC uses the CameraLink standard. This standard is supported by many frame grabber cards on which the raw image data will be dumped. The test board is able to grab images at the 300Mbps. This means that 8/10/12 bit images are grabbed by the system at 300MHz per LVDS channel.

## 2 FRAME GRABBER AND PC

A frame grabber card which can accept the Medium and Full CameraLink interface was chosen to complete the test system interface. The NI PCIe-1433 allows raw image data to be dumped at 4.8Gbit/s on the PC. This card is fitted in a PCI Express slot of the test system PC and uses two dedicated cables to connect to the CMV300 board.

The PCIe-1433 frame grabber card comes with an API, which can easily be used in LabVIEW. This API is used to communicate with the frame grabber card and read the image from memory to display it on the screen.

See <http://www.ni.com/pdf/manuals/372015a.pdf> for more details on the PCIe 1433 frame grabber card.

The PC in which the frame grabber card is inserted and on which the software is running has the following minimum requirements:

- Intel Core i3
- 2 Gbyte DDR memory
- 500GB SATA hard disk
- Intel HD Graphics
- 16x DVD-ROM
- PCI-Express slots

On this PC, the LabVIEW RunTime Engine and the Vision Development Module will be installed. A dedicated CMV300 Labview executable is written to grab and save images from the camera board. A detailed description of the software can be found in the next section.



### 3 INSTALLING THE SYSTEM

When installing the system, the following connections have to be made:

1. Connect the PC to its peripherals (keyboard, mouse and monitor, power)
2. Connect the CMV300 PCB to the PC via the two camera link cables. Use either cable to connect the camera link connector on the casing labeled 'base' to the PC camera link port labeled 'base'. Use the other cable (medium) to connect PCB port 'medium' to the other frame grabber port on the PC.
3. Connect the CMV300 system's power supply to the 5VDC input pin on the case and to a wall outlet.

Note: The FPGA configuration is stored in an EPROM on the PCB. The FPGA is configured automatically when the power is switched on and LED2 will light up.



## 4 RUNNING THE SYSTEM

### 4.1 STARTING THE SYSTEM

Plug in the CameraLink cables and then plug in the power supply and wait for the FPGA to be configured before starting the software (LED1&2 should be lit).

Log on to the PC using the ‘demo user’ account. No password is needed.

On the Desktop, there is a link to the demo software executable, called “Demo Software – CMV300.exe”. Double clicking this shortcut will launch the demo software.

### 4.2 SOFTWARE OVERVIEW

Next figure shows a screenshot of the demo software.

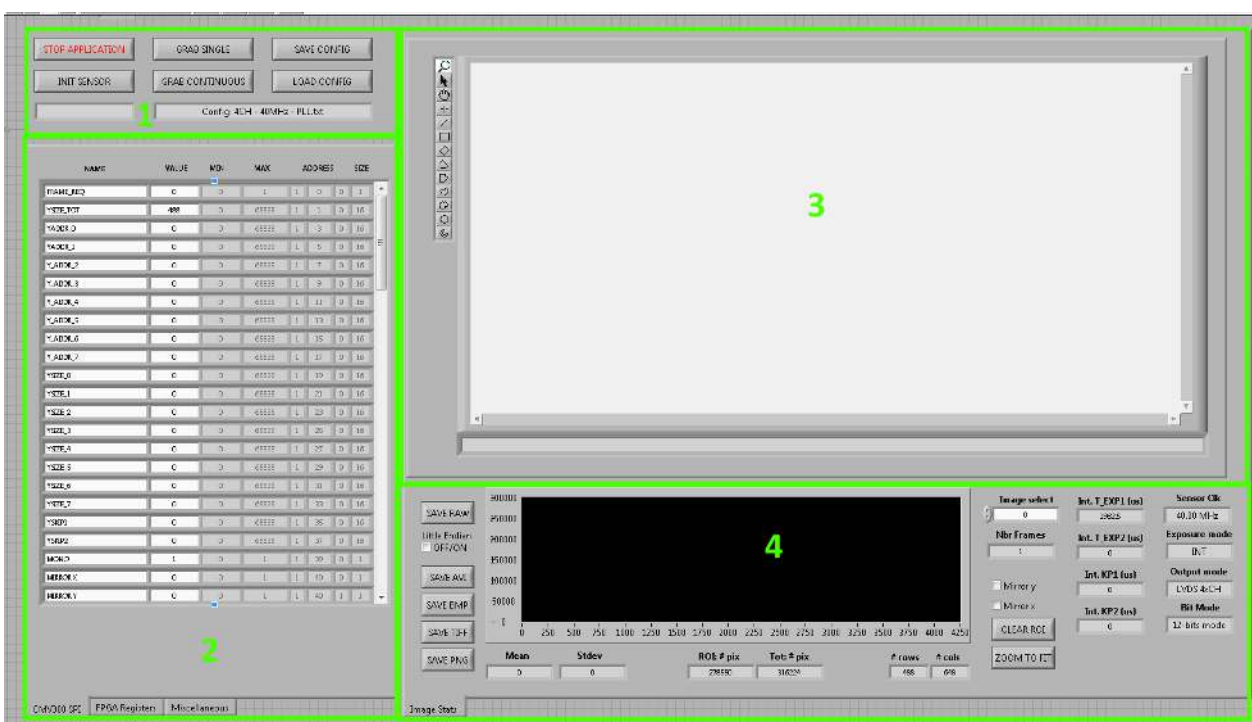

The four main areas of the software are:

1. **Control area:** The user can control the software (grab frames, save and load configuration files ...) via a number of push buttons.
2. **Register settings area:** The user can set the registers of the sensor. The CMV300 SPI tab controls the sensors SPI registers, the FPGA registers controls some specific FPGA settings mainly for external exposure mode. And the Miscellaneous tab controls the sensor and FPGA initialization and temperature read-out.
3. **Image area:** The images acquired from the sensor are displayed in this image viewing plane.
4. **Image statistics area:** A number of image and software statistics are displayed here.

Next section will explain the different software functions in more detail.

### 4.3 SOFTWARE DETAILS

#### 4.3.1 CONTROL AREA

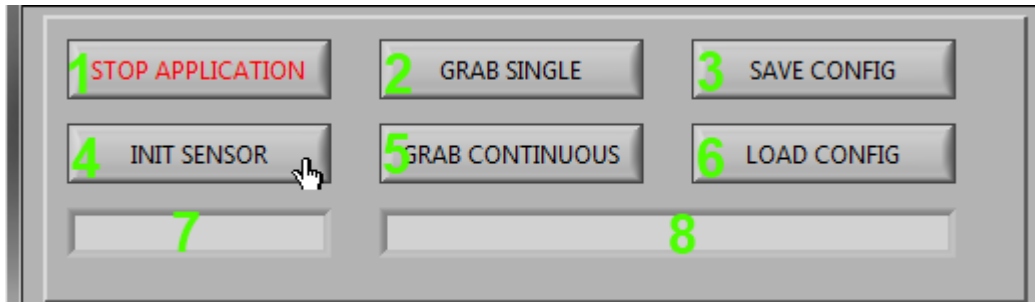

The 8 controls in the Control Area are:

1. **STOP APPLICATION** button: Click this button to stop the application from running and exit to the Labview run-time environment. Then the window can be closed. It is required to use this button to stop the program, instead of closing the window while it is still running.
2. **GRAB SINGLE** button: Click this button to grab a single sequence of frames. The number of frames in the sequence is set in the 'register settings area'. When the single grab has finished, the 'image 'area' will be updated.
3. **SAVE CONFIG** button: By clicking this button, a configuration file can be saved. A configuration file is a human-readable version of the sensor register map. The saved text file has the same information as the register map that is saved using the 'save regmap button'. The advantage of a configuration file is that it can be reloaded into the software using the 'load config button'. (Tip: save the configuration files with a .txt extension).
4. **INIT SENSOR** button: This initializes the sensor (reset and write default SPI registers). This should be done first after you have started the program or when you encounter some errors when grabbing a frame.
5. **GRAB CONTINUOUS** button: This button has the same function as the 'grab single' button. The difference is that this button has a different latching action. By clicking it once, it will be enabled. As long as it is enabled, the software will continuously request sequences of frames and update the image area. This mode is also called 'video mode'. To stop the video mode, click the 'grab continuous button' again. This will reset the button to its disabled state.
6. **LOAD CONFIG** button: By clicking this button, a configuration file can be loaded into the software. When this is done, all settings from the 'register settings area' are overwritten with the information from the configuration file. The new settings are automatically transferred to FPGA and sensor (no need to click the 'reload FPGA button' after loading a configuration file). (Tip: it is allowed to load a configuration file while in video mode. The new settings will reflect in the images immediately.)
7. **SENSOR MESSAGE:** This text box will give you info on the initialization and acquisition of the sensor.



8. **CONFIG INFO:** If this text box contains the configuration file you are currently using. If it is empty it is running with the default (startuo/init) settings.

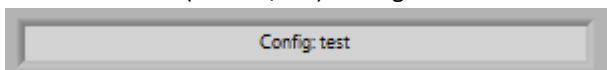

Note: On the Desktop of the evaluation PC, there is an example of a configuration file. This file has been saved using the 'save config button'. You can load this configuration file into the software with the 'load config button'. This configuration file contains the advised values for optimal sensor operation.

#### 4.3.2 REGISTER SETTINGS AREA

NAME	VALUE	MIN	MAX	ADDRESS			SIZE
FRAME_REQ	0	0	1	1	0	0	1
YSIZE_TOT	488	0	65535	1	1	0	16
YADDR_0	0	0	65535	1	3	0	16
YADDR_1	0	0	65535	1	5	0	16
Y_ADDR_2	0	0	65535	1	7	0	16
Y_ADDR_3	0	0	65535	1	9	0	16
Y_ADDR_4	0	0	65535	1	11	0	16
Y_ADDR_5	0	0	65535	1	13	0	16
Y_ADDR_6	0	0	65535	1	15	0	16
Y_ADDR_7	0	0	65535	1	17	0	16
YSIZE_0	0	0	65535	1	19	0	16
YSIZE_1	0	0	65535	1	21	0	16
YSIZE_2	0	0	65535	1	23	0	16
YSIZE_3	0	0	65535	1	25	0	16
YSIZE_4	0	0	65535	1	27	0	16
YSIZE_5	0	0	65535	1	29	0	16
YSIZE_6	0	0	65535	1	31	0	16
YSIZE_7	0	0	65535	1	33	0	16
YSKIP1	0	0	65535	1	35	0	16
YSKIP2	0	0	65535	1	37	0	16
MONO	1	0	1	1	39	0	1
MIRROR X	0	0	1	1	40	0	1
MIRROR Y	0	0	1	1	40	1	1

CMV300 SPI    FPGA Registers    Miscellaneous

The 'register settings area' can be used to change all sensor registers. Almost all registers in the sensor can be changed or readout from here. Most of these settings can be left unchanged by the user of the evaluation system.

Every register setting in this list refers to a sensor register (see datasheet for complete register map). The user of the evaluation system can only change the 'value' of the registers. The other entries are informational. (Tip: the register addresses (third column from the right) match the address values in the register map in the datasheet).

Upon hitting the enter key after changing a value of a register, it is uploaded to the FPGA. Note that it is allowed to change register settings while in video mode. The changes will reflect immediately in the displayed images. Also hitting the “arrow up/down” key on the keyboard will increase/decrease the value and immediately upload it to the FPGA.

### 4.3.3 IMAGE AREA

The images that are acquired from the sensor are displayed in the ‘image area’. Only one image is displayed. If a sequence of frames is acquired, the entire burst is in the memory. A selection switch in the ‘image statistics area’ can be used to select which frame from the sequence is displayed.

Next to the image plane is a small toolbar with image controls. These can be used to zoom in the image and to select region of interest (ROI) contours for the image statistics. Next figure shows this toolbar.

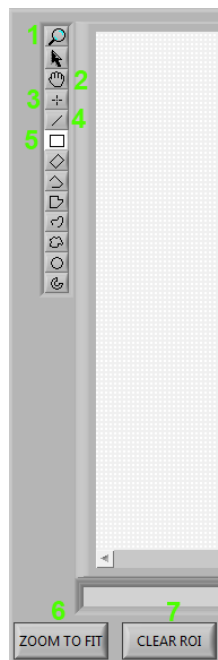

Of these tools, the following 5 are most commonly used:

1. **ZOOM:** When selected, the mouse pointer turns into a magnifying glass when moved over the image. Every click will zoom into the image by 1X. When holding the SHIFT key on the keyboard, the mouse pointer will turn into a magnifying glass with a small ‘minus sign’ in it. Clicking in the image with the SHIFT key held will zoom the image out by 1X.
2. **PAN:** When the image is zoomed, this function allows the user to pan the image.
3. **POINT ROI:** Allows the user to set an ROI in the image of exactly 1 pixel. Click on the image to place the point ROI.
4. **LINE ROI:** Allows the user to set a line ROI in the image. Click on the image to set the first point of the line. Hold the left mouse key and drag to where the end point of the line should be. Release the left mouse button to place the line.
5. **RECTANGLE ROI:** Allows the user to set a rectangular ROI in the image. Click on the image to set the first corner of the rectangle. Hold the left mouse key and drag to the point where the opposite corner of the rectangle should come. Release the left mouse button to place the rectangle.
6. **ZOOM TO FIT:** Allows to zoom out so that the entire image fits in the window.
7. **CLEAR ROI:** Allows the user to clear the current ROI.

More information on the ROI statistics can be found in the ‘image statistics area’ section.

### 4.3.4 IMAGE STATISTICS AREA

Next figure shows the image statistics area.

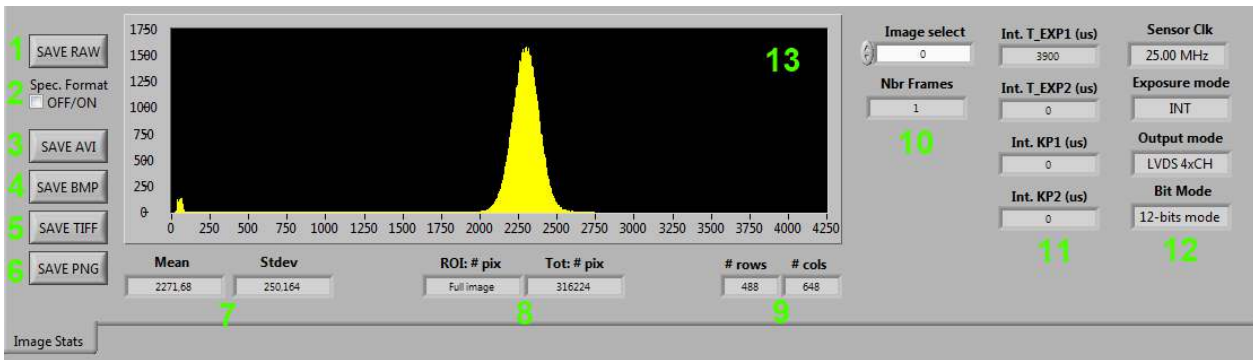

The 'image statistics area' consists of:

1. **SAVE RAW** button: Clicking this button will save the requested images in a raw file format. Set the path and name and the software will automatically add the frame number per image.
2. **Spec. Format**: You can save the RAW files in a slightly different format, needed for some software applications to read out RAW images properly.
3. **SAVE AVI** button: If a sequence of images is acquired, the entire sequence can be saved as a movie with the avi format. Click the button and select the path and file name for the movie (including the .avi extension).
4. **SAVE BMP** button: Click this button to save the images that are in memory as bitmap files. For every image of the sequence that is in memory, two bitmaps will be saved. One with the highest 8 bits of the 10-bit image (called \_msb.bmp). and one with the lowest 8 bits of the same 10-bit image (called \_lsb.bmp). To save the bitmaps, click on the 'save bmp button', navigate to the correct path and enter a name for the images (without the .bmp extension). The software will add the frame number, lsb or msb indicator and .bmp extension to the name that has been entered for every bitmap that will be saved.
5. **SAVE TIFF** button: Clicking this button will save the images in a lossless TIFF file format. Because the images are 10/12bit most viewers cannot open them directly. ImageJ (<http://rsbweb.nih.gov/ij/>) can open our TIFF files.
6. **SAVE PNG** button: Clicking it will save the images in a lossless PNG file format.
7. **AVERAGE and STANDARD DEVIATION**: Show the average and standard deviation of the selected image in 10-bit values. (Note: see next section for explanation of ROI image statistics)
8. **ROI and Total Image**: Gives you the size of the currently used ROI and the total window size of the image.
9. **ROWS and COLUMNS**: Gives you the number of rows and columns of the total image.
10. **Nbr FRAMES**: Here you can see the number of frames grabbed and with the selection arrows, you can select which captured frame you want to see.
11. **EXPOSURE**: Gives you the exposure times in microseconds.
12. **MODE**: Gives more info on the different modes the sensor is currently in.
13. **HISTOGRAM**: Shows the 12-bit histogram of the image that is displayed in the 'image area'. (Note: see next section for explanation of ROI image statistics)

#### 4.3.4.1 IMAGE STATISTICS IN ROI MODE

By default, the image statistics apply to the entire image. If statistics of certain areas in the image are desired, the ROI functionality can be used. If an ROI is placed on the image, all statistics that are displayed (histogram, average and standard deviation) are of all pixels that are defined by the ROI.

Next figures show examples of the ROI results for different ROIs on the same image. In the examples, note histogram, the average and standard deviation values and the 'ROI # pix' value.

**No ROI:**

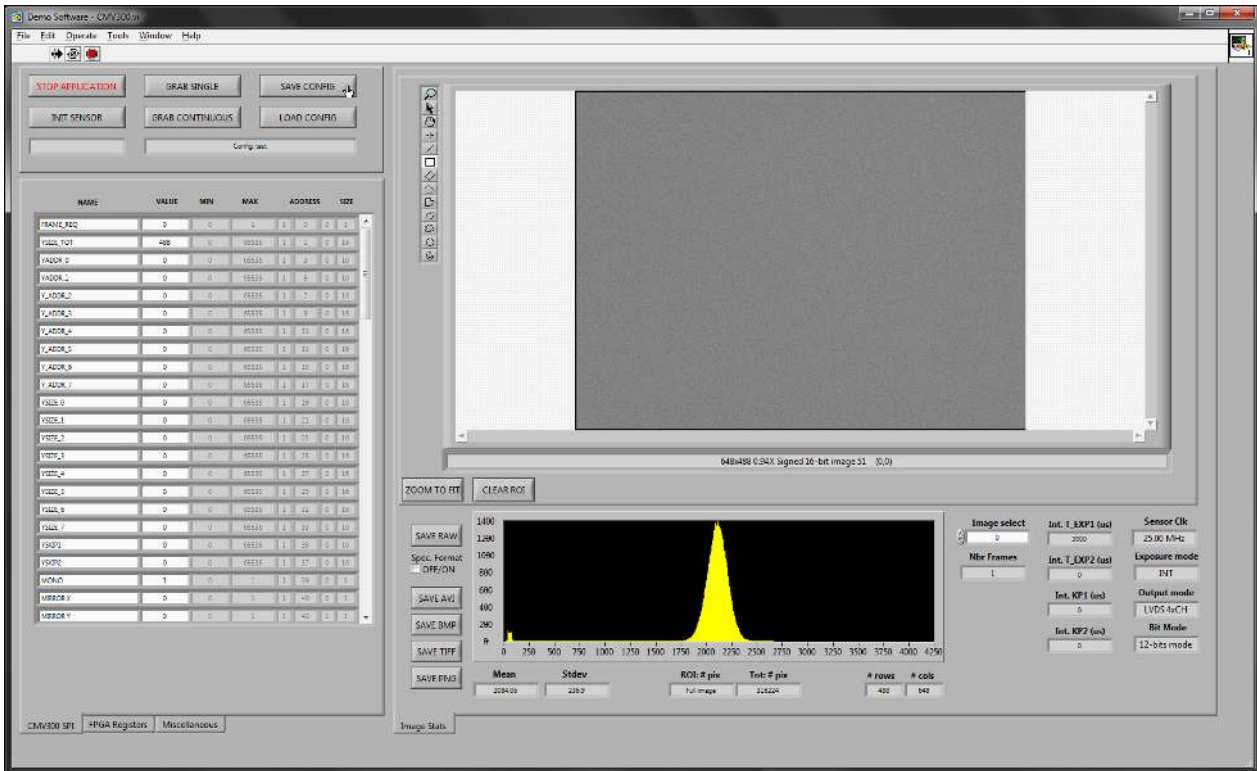

**Rectangle ROI:**

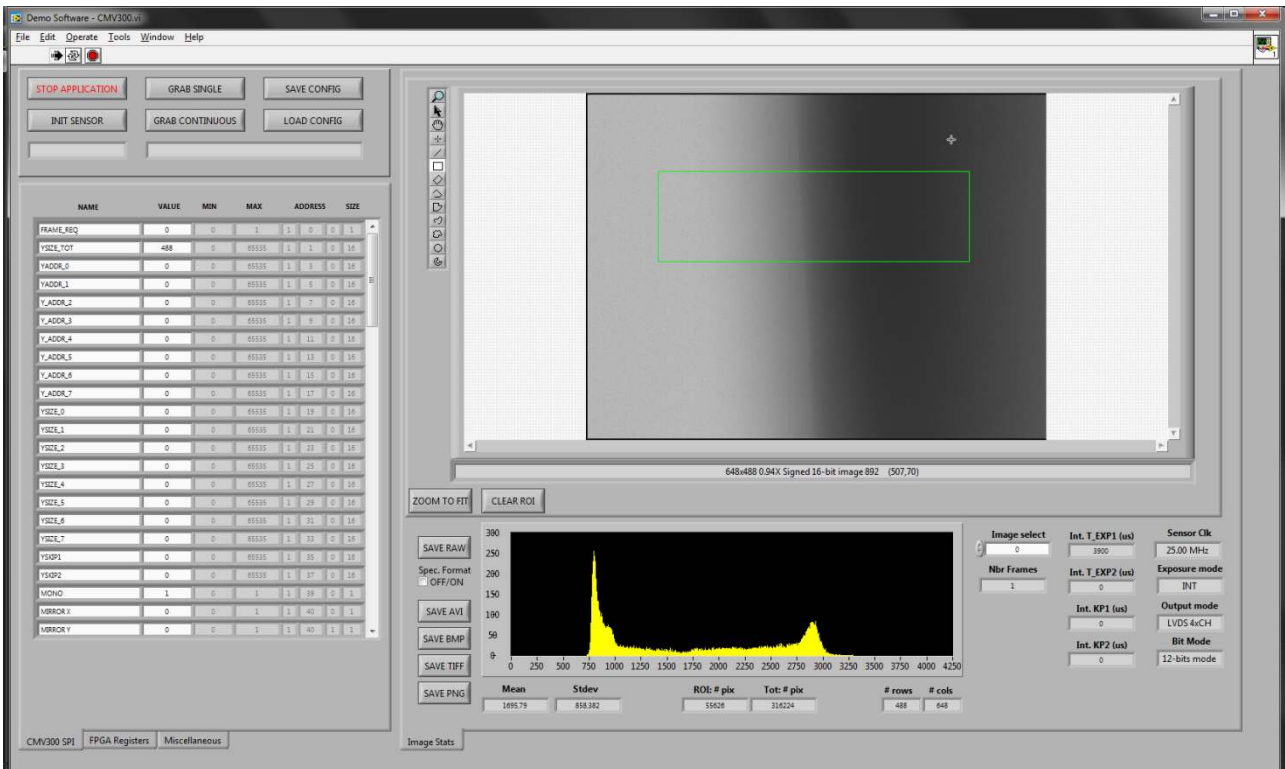



**Line ROI:**

648x488 0.94X Signed 16-bit image 3108 (441,326)

NAME	VALUE	MIN	MAX	ADDRESS	SIZE
YSCALE_4	0	0	65535	1	27
YSCALE_5	0	0	65535	1	28
YSCALE_6	0	0	65535	1	29
YSCALE_7	0	0	65535	1	30
YSCALE_8	0	0	65535	1	31
YSCALE_9	0	0	65535	1	32
YSCALE_10	0	0	65535	1	33
YSCALE_11	0	0	65535	1	34
YSCALE_12	0	0	65535	1	35
YSCALE_13	0	0	65535	1	36
YSCALE_14	0	0	65535	1	37
YSCALE_15	0	0	65535	1	38
YSCALE_16	0	0	65535	1	39
YSCALE_17	0	0	65535	1	40
YSCALE_18	0	0	65535	1	41
YSCALE_19	0	0	65535	1	42
YSCALE_20	0	0	65535	1	43
YSCALE_21	0	0	65535	1	44
YSCALE_22	0	0	65535	1	45
YSCALE_23	0	0	65535	1	46
YSCALE_24	0	0	65535	1	47
YSCALE_25	0	0	65535	1	48
YSCALE_26	0	0	65535	1	49
YSCALE_27	0	0	65535	1	50
YSCALE_28	0	0	65535	1	51
YSCALE_29	0	0	65535	1	52
YSCALE_30	0	0	65535	1	53
YSCALE_31	0	0	65535	1	54
YSCALE_32	0	0	65535	1	55
YSCALE_33	0	0	65535	1	56
YSCALE_34	0	0	65535	1	57
YSCALE_35	0	0	65535	1	58
YSCALE_36	0	0	65535	1	59
YSCALE_37	0	0	65535	1	60
YSCALE_38	0	0	65535	1	61
YSCALE_39	0	0	65535	1	62
YSCALE_40	0	0	65535	1	63
YSCALE_41	0	0	65535	1	64
YSCALE_42	0	0	65535	1	65
YSCALE_43	0	0	65535	1	66
YSCALE_44	0	0	65535	1	67
YSCALE_45	0	0	65535	1	68
YSCALE_46	0	0	65535	1	69
YSCALE_47	0	0	65535	1	70
YSCALE_48	0	0	65535	1	71
YSCALE_49	0	0	65535	1	72
YSCALE_50	0	0	65535	1	73
YSCALE_51	0	0	65535	1	74
YSCALE_52	0	0	65535	1	75
YSCALE_53	0	0	65535	1	76
YSCALE_54	0	0	65535	1	77
YSCALE_55	0	0	65535	1	78
YSCALE_56	0	0	65535	1	79
YSCALE_57	0	0	65535	1	80
YSCALE_58	0	0	65535	1	81
YSCALE_59	0	0	65535	1	82
YSCALE_60	0	0	65535	1	83
YSCALE_61	0	0	65535	1	84
YSCALE_62	0	0	65535	1	85
YSCALE_63	0	0	65535	1	86
YSCALE_64	0	0	65535	1	87
YSCALE_65	0	0	65535	1	88
YSCALE_66	0	0	65535	1	89
YSCALE_67	0	0	65535	1	90
YSCALE_68	0	0	65535	1	91
YSCALE_69	0	0	65535	1	92
YSCALE_70	0	0	65535	1	93
YSCALE_71	0	0	65535	1	94
YSCALE_72	0	0	65535	1	95
YSCALE_73	0	0	65535	1	96
YSCALE_74	0	0	65535	1	97
YSCALE_75	0	0	65535	1	98
YSCALE_76	0	0	65535	1	99
YSCALE_77	0	0	65535	1	100
YSCALE_78	0	0	65535	1	101
YSCALE_79	0	0	65535	1	102
YSCALE_80	0	0	65535	1	103
YSCALE_81	0	0	65535	1	104
YSCALE_82	0	0	65535	1	105
YSCALE_83	0	0	65535	1	106
YSCALE_84	0	0	65535	1	107
YSCALE_85	0	0	65535	1	108
YSCALE_86	0	0	65535	1	109
YSCALE_87	0	0	65535	1	110
YSCALE_88	0	0	65535	1	111
YSCALE_89	0	0	65535	1	112
YSCALE_90	0	0	65535	1	113
YSCALE_91	0	0	65535	1	114
YSCALE_92	0	0	65535	1	115
YSCALE_93	0	0	65535	1	116
YSCALE_94	0	0	65535	1	117
YSCALE_95	0	0	65535	1	118
YSCALE_96	0	0	65535	1	119
YSCALE_97	0	0	65535	1	120
YSCALE_98	0	0	65535	1	121
YSCALE_99	0	0	65535	1	122
YSCALE_100	0	0	65535	1	123
YSCALE_101	0	0	65535	1	124
YSCALE_102	0	0	65535	1	125
YSCALE_103	0	0	65535	1	126
YSCALE_104	0	0	65535	1	127
YSCALE_105	0	0	65535	1	128
YSCALE_106	0	0	65535	1	129
YSCALE_107	0	0	65535	1	130
YSCALE_108	0	0	65535	1	131
YSCALE_109	0	0	65535	1	132
YSCALE_110	0	0	65535	1	133
YSCALE_111	0	0	65535	1	134
YSCALE_112	0	0	65535	1	135
YSCALE_113	0	0	65535	1	136
YSCALE_114	0	0	65535	1	137
YSCALE_115	0	0	65535	1	138
YSCALE_116	0	0	65535	1	139
YSCALE_117	0	0	65535	1	140
YSCALE_118	0	0	65535	1	141
YSCALE_119	0	0	65535	1	142
YSCALE_120	0	0	65535	1	143
YSCALE_121	0	0	65535	1	144
YSCALE_122	0	0	65535	1	145
YSCALE_123	0	0	65535	1	146
YSCALE_124	0	0	65535	1	147
YSCALE_125	0	0	65535	1	148
YSCALE_126	0	0	65535	1	149
YSCALE_127	0	0	65535	1	150
YSCALE_128	0	0	65535	1	151
YSCALE_129	0	0	65535	1	152
YSCALE_130	0	0	65535	1	153
YSCALE_131	0	0	65535	1	154
YSCALE_132	0	0	65535	1	155
YSCALE_133	0	0	65535	1	156
YSCALE_134	0	0	65535	1	157
YSCALE_135	0	0	65535	1	158
YSCALE_136	0	0	65535	1	159
YSCALE_137	0	0	65535	1	160
YSCALE_138	0	0	65535	1	161
YSCALE_139	0	0	65535	1	162
YSCALE_140	0	0	65535	1	163
YSCALE_141	0	0	65535	1	164
YSCALE_142	0	0	65535	1	165
YSCALE_143	0	0	65535	1	166
YSCALE_144	0	0	65535	1	167
YSCALE_145	0	0	65535	1	168
YSCALE_146	0	0	65535	1	169
YSCALE_147	0	0	65535	1	170
YSCALE_148	0	0	65535	1	171
YSCALE_149	0	0	65535	1	172
YSCALE_150	0	0	65535	1	173
YSCALE_151	0	0	65535	1	174
YSCALE_152	0	0	65535	1	175
YSCALE_153	0	0	65535	1	176
YSCALE_154	0	0	65535	1	177
YSCALE_155	0	0	65535	1	178
YSCALE_156	0	0	65535	1	179
YSCALE_157	0	0	65535	1	180
YSCALE_158	0	0	65535	1	181
YSCALE_159	0	0	65535	1	182
YSCALE_160	0	0	65535	1	183
YSCALE_161	0	0	65535	1	184
YSCALE_162	0	0	65535	1	185
YSCALE_163	0	0	65535	1	186
YSCALE_164	0	0	65535	1	187
YSCALE_165	0	0	65535	1	188
YSCALE_166	0	0	65535	1	189
YSCALE_167	0	0	65535	1	190
YSCALE_168	0	0	65535	1	191
YSCALE_169	0	0	65535	1	192
YSCALE_170	0	0	65535	1	193
YSCALE_171	0	0	65535	1	194
YSCALE_172	0	0	65535	1	195
YSCALE_173	0	0	65535	1	196
YSCALE_174	0	0	65535	1	197
YSCALE_175	0	0	65535	1	198
YSCALE_176	0	0	65535	1	199
YSCALE_177	0	0	65535	1	200
YSCALE_178	0	0	65535	1	201
YSCALE_179	0	0	65535	1	202
YSCALE_180	0	0	65535	1	203
YSCALE_181	0	0	65535	1	204
YSCALE_182	0	0	65535	1	205
YSCALE_183	0	0	65535	1	206
YSCALE_184	0	0	65535	1	207
YSCALE_185	0	0	65535	1	208
YSCALE_186	0	0	65535	1	209
YSCALE_187	0	0	65535	1	210
YSCALE_188	0	0	65535	1	211
YSCALE_189	0	0	65535	1	212
YSCALE_190	0	0	65535	1	213
YSCALE_191	0	0	65535	1	214
YSCALE_192	0	0	65535	1	215
YSCALE_193	0	0	65535	1	216
YSCALE_194	0	0	65535	1	217
YSCALE_195	0	0	65535	1	218
YSCALE_196	0	0	65535	1	219
YSCALE_197	0	0	65535	1	220
YSCALE_198	0	0	65535	1	221
YSCALE_199	0	0	65535	1	222
YSCALE_200	0	0	65535	1	223
YSCALE_201	0	0	65535	1	224
YSCALE_202	0	0	65535	1	225
YSCALE_203	0	0	65535	1	226
YSCALE_204	0	0	65535	1	227
YSCALE_205	0	0	65535	1	228
YSCALE_206	0	0	65535	1	229
YSCALE_207	0	0	65535	1	230
YSCALE_208	0	0	65535	1	231
YSCALE_209	0	0	65535	1	232
YSCALE_210	0	0	65535	1	233
YSCALE_211	0	0	65535	1	234
YSCALE_212	0	0	65535	1	235
YSCALE_213	0	0	65535	1	236
YSCALE_214	0	0	65535	1	237
YSCALE_215	0	0	65535	1	238
YSCALE_216	0	0	65535	1	239
YSCALE_217	0	0	65535	1	240
YSCALE_218	0	0	65535	1	241
YSCALE_219	0	0	65535	1	242
YSCALE_220	0	0	65535	1	243
YSCALE_221	0	0	65535	1	244
YSCALE_222	0	0	65535	1	245
YSCALE_223	0	0	65535	1	246
YSCALE_224	0	0	65535	1	247
YSCALE_225	0	0	65535	1	248
YSCALE_226	0	0	65535	1	249
YSCALE_227	0	0	65535	1	250
YSCALE_228	0	0	65535	1	251
YSCALE_229	0	0	65535	1	252
YSCALE_230	0	0	65535	1	253
YSCALE_231	0	0	65535	1	254
YSCALE_232	0	0	65535	1	255
YSCALE_233	0	0	65535	1	256
YSCALE_234	0	0	65535	1	257
YSCALE_235	0	0	65535	1	258
YSCALE_236	0	0	65535	1	259
YSCALE_237	0	0	65535	1	260
YSCALE_238	0	0	65535	1	261



### 4.3.5 SOFTWARE STARTUP

After the software is loaded, first click the INIT SENSOR button, to initialize the sensor. This does a sensor reset, loads the registers currently filled in the register list and does LVDS training. If that is OK, you can start grabbing a frame by clicking GRAB SINGLE or GRAB CONTINUOUS. If this works ok, the system is working fine.

### 4.3.6 ERRORS

When something goes wrong during frame grabbing you will get an Error message, see the error in the INFO MESSAGE text box in the left top corner and a detail error explanation on the Miscellaneous tab. Click "Continue" for the application to continue or "Stop" for the program to stop (then you will have to close and restart the exe again).

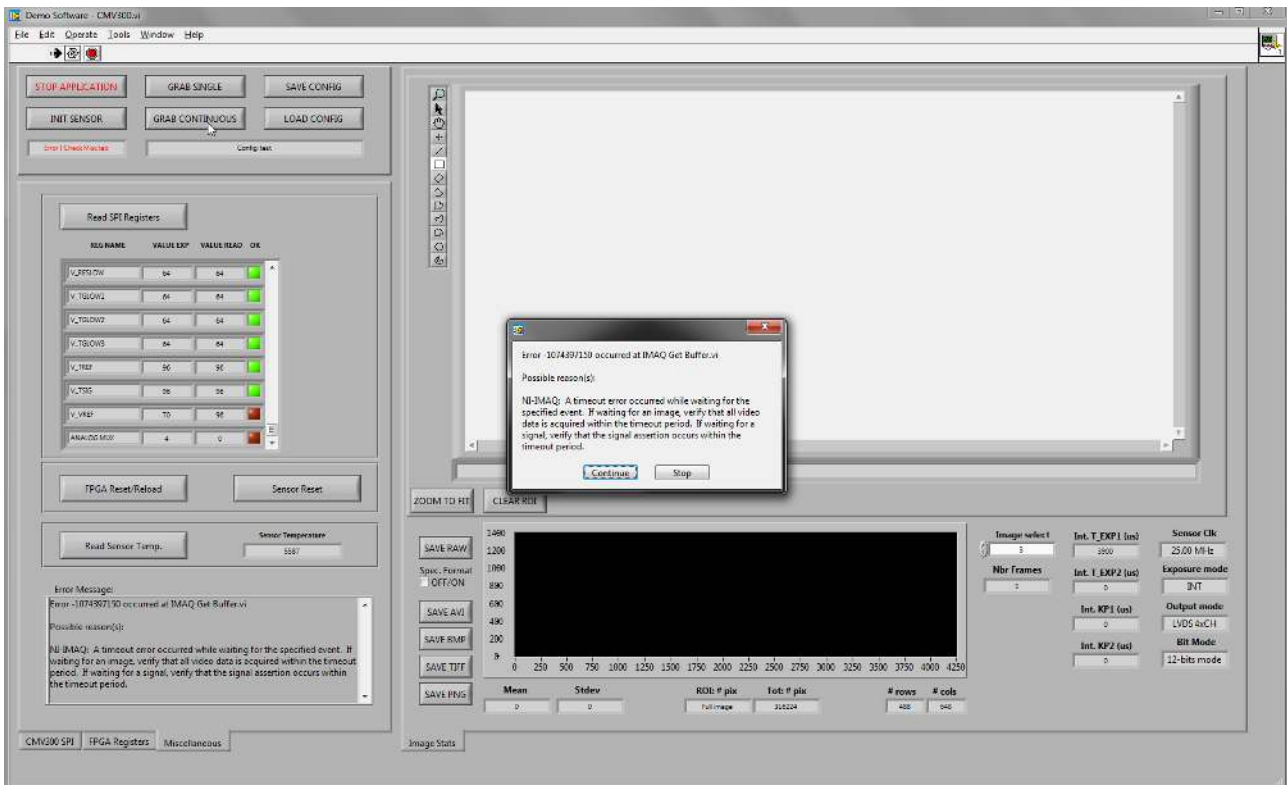

Try to fix the error by resetting the sensor (to the default register values as stated in the datasheet), reload the FPGA and then read-out the registers to see if there are any conflicts (=red light) in the registers.

The run the LVDS training on the FPGA Registers tab, to see if the FPGA can train OK on the sensor data (all lights on the tab should be green).

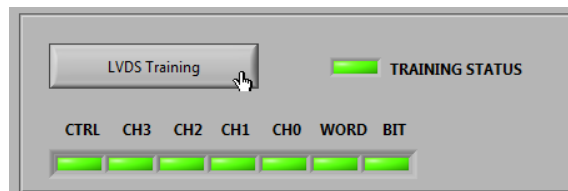

You can also try to reinitialize the sensor by clicking the INIT SENSOR button.

If everything fails, close the application, remove and reconnect the power supply, check the LEDs for a correct working and restart the application.

### 4.4 CHANGE FREQUENCY

You have the possibility to change the sensor frequency between 10 and 40MHz. You can do this by changing registers Clk Sen: Multiplication Factor and Division Factor. The division factor should be kept at 10 or lower and the multiplication factor should be between 1 and the division factor.

After you changed the registers, the clock frequency will be shown in the text box next to the Clk Sen Update button. If the text is red, it means the clock has not changed yet in the FPGA. Click the INIT SENSOR button, for the clock change to happen (the text will become black again).

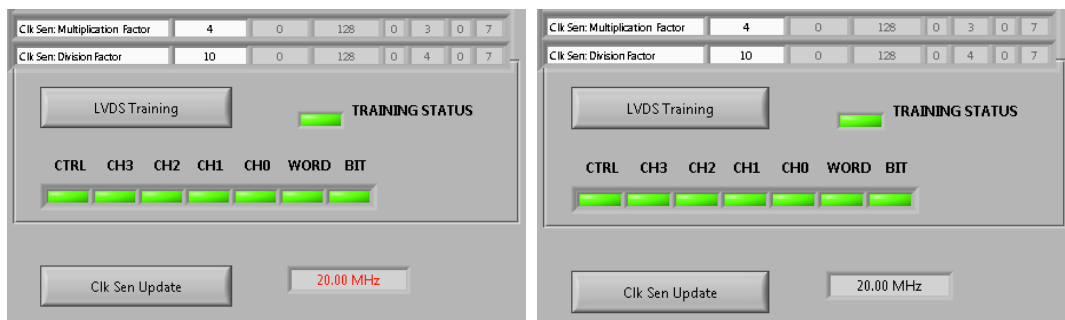

If the initialization was OK, you can now grab images. Don't forget that the ADC gain and the PLL settings may need to change to get a good image. For certain clock speeds, the initialization does not work well. This is caused by the fpga and not the sensor. Try again or choose a different clock speed.