

PART NO	DRAWING NO	BUYER COLOR	VENDOR COLOR	PIN针电镀
1003-026-BL-KIT	671-594-A		黑色 (3.0版)	镀金30u"

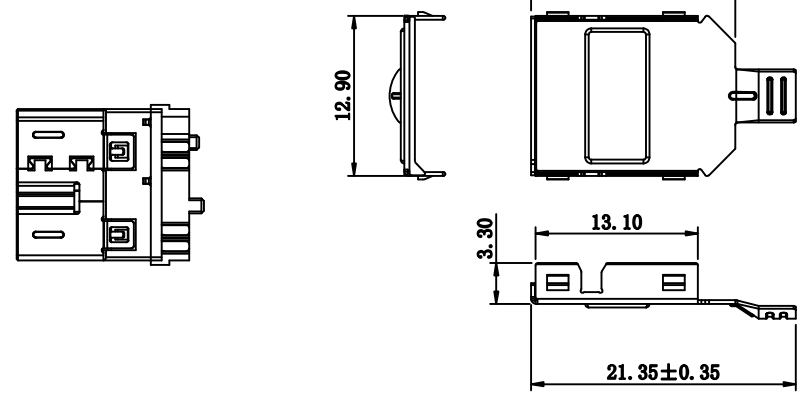
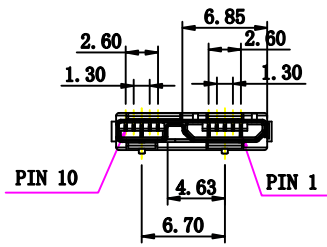
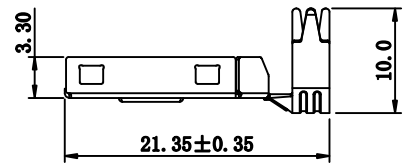
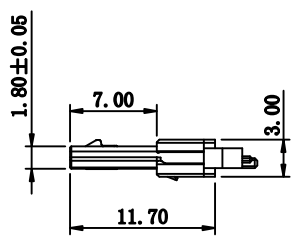

Specifications:

1. Current Rating: 1.0A at 30V AC.
2. Withstanding Voltage: 100V AC for one minute.
3. Insulation Resistance: 100MΩ Min.
4. Contact Resistance: 50mΩ Max.
5. Mating Force: 3.57kgf Max.
6. Unmating Force: 1.02kgf Min

CnC Tech, LLC
Industrial Cable and Connector Technology

DRAWN BY:	DATE: 2019/09/25	DESCRIPTION: MICRO USB 3.0 30u"
CHECKED BY:	SHEET 1 of 2	ITEM NO. As above
APPROVED BY:	SCALE 1:1	REV. B/1 UNIT: mm



UNIT:MM

REVISION INFORMATION

Rev.	Rev. Date	Modified By	Brief Description
B/0	19-07-22	T0722A	NEW DRAWING
B/1	19-09-25	T0925A	change Gold Plated

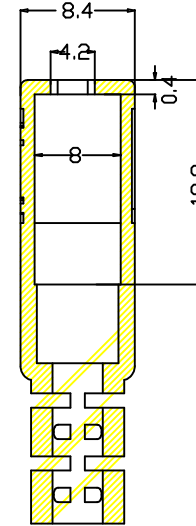
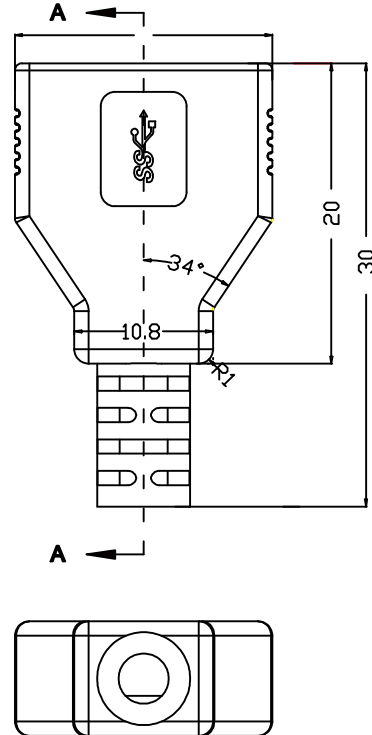
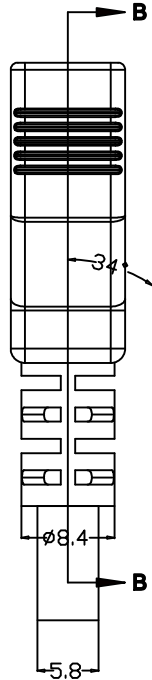

SECTION A-A

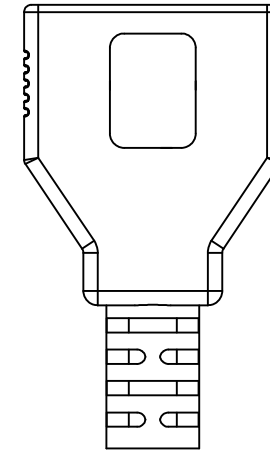

PART NO

1003-026-BL-KIT

NO.	NAME	QTY	SPECIFICATION
④	PE BAG	1/200	CLEAR SIZE:300X400X0.05mm PRINT BLACK"MADE IN CHINA"+*200PCS"
③	PE BAG	1	CLEAR SIZE:60X80X0.05mm PRINT BLACK"MADE IN CHINA"+*1PC"
②	OUT JACKET	1	MCBT-1-2-1(PVC 55P BLACK)
①	CONN	1set	MICRO USB 3.0,ASSEMBLY TYPE B/M 10P WITH HOOD

CnC Tech, LLC
Industrial Cable and Connector Technology

DRAWN BY:	DATE: 2019/09/25	DESCRIPTION: MICRO USB 3.0 30u"
CHECKED BY:	SHEET 2 of 2	ITEM NO. As above
APPROVED BY:	SCALE 1:1	REV. B/1 UNIT: mm