



Tango 33

Thru-hole Quad Band 2G/3G Antenna



Key Features

- Quad Band 2G/GPRS
- 3G/UMTS
- High Gain

General Description

The Tango 33 is a hinged bolt through antenna covering quad band 2G as well as 3G mobile frequencies.

Boasting a peak gain of 5dBi, this high performance antenna is suitable for applications like touch screen kiosks, predictive maintenance IoT devices, remote monitoring and more.

The antenna is supplied as standard with 650 to 670mm cable and an SMA male connector. Alternative connectors and cable lengths can be specified for volume orders.

Additional Considerations

- Through Hole
- Sturdy mechanism

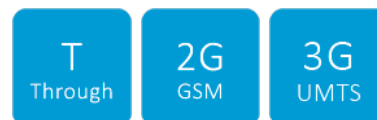

Tango 33

Thru-hole Quad Band 2G/3G Antenna

Electrical Specifications

Operating Temperature:	-45 - +75°C
Storage Temperature:	-45 - +75°C
Impedance:	50 Ohm
Peak Gain:	5dBi
VSWR:	≤ 2
Frequency:	850/900/1800/1900/2100MHz
Maximum Input Power:	50W
Polarization:	Vertical

Mechanical Specifications

Dimensions:	L266 x 12.6mm Ø
Cable:	RG178
Connector:	SMA Male
Mounting Method:	Screw (thread size: M7)
Maximum Material Thickness:	5.5mm

VSWR and Return Loss

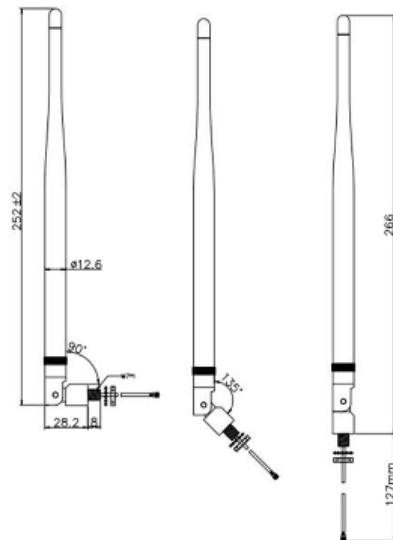
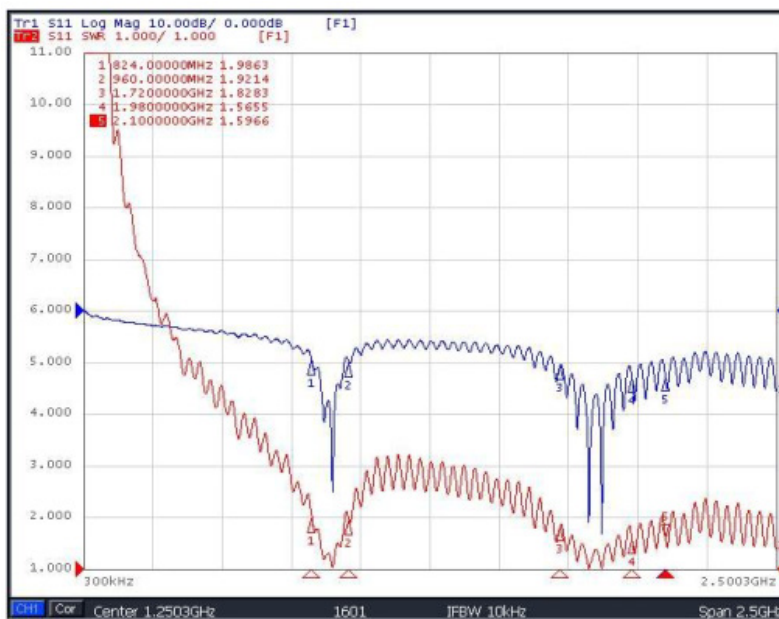

3D Radiation Patterns 750 and 850MHz

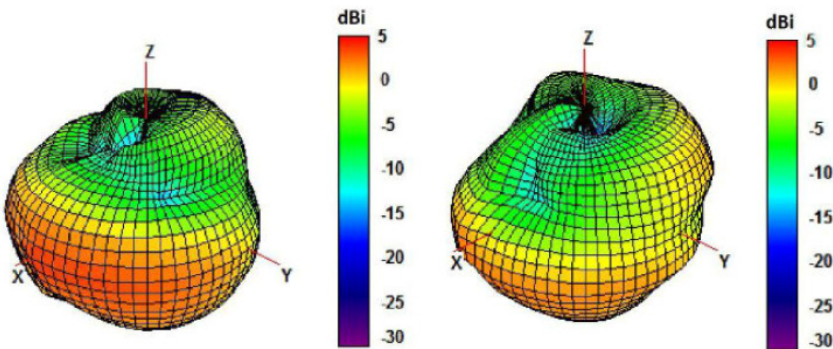

940 and 1750MHz

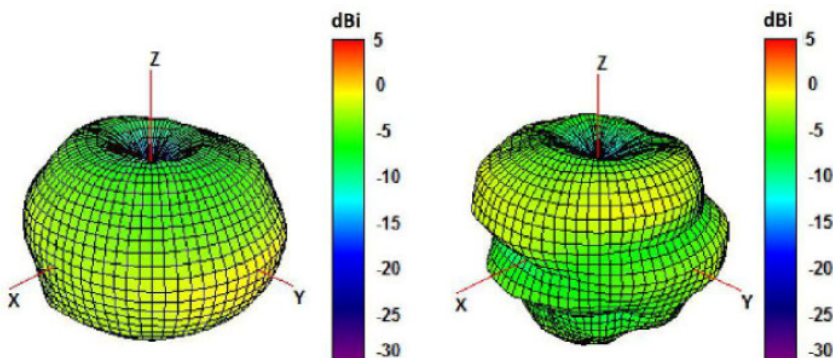

1850 and 1950MHz

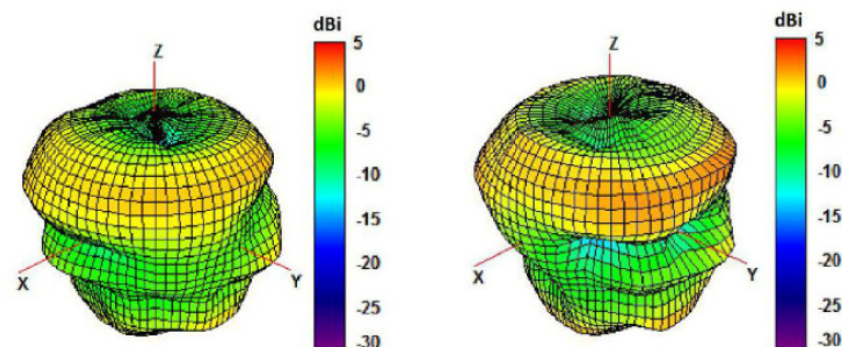



Tango 33

Thru-hole Quad Band 2G/3G Antenna

2100 and 2600MHz

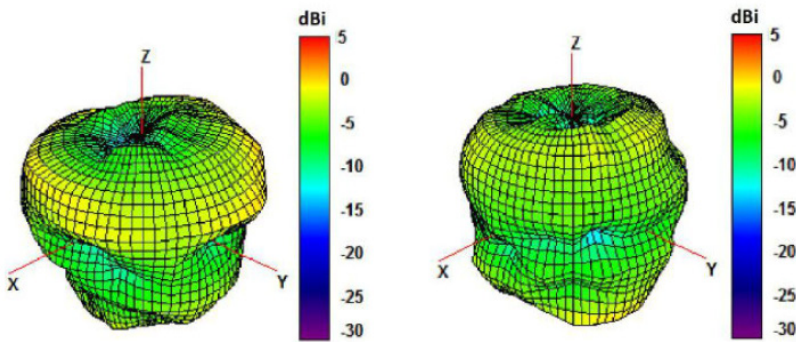

2D Radiation Patterns

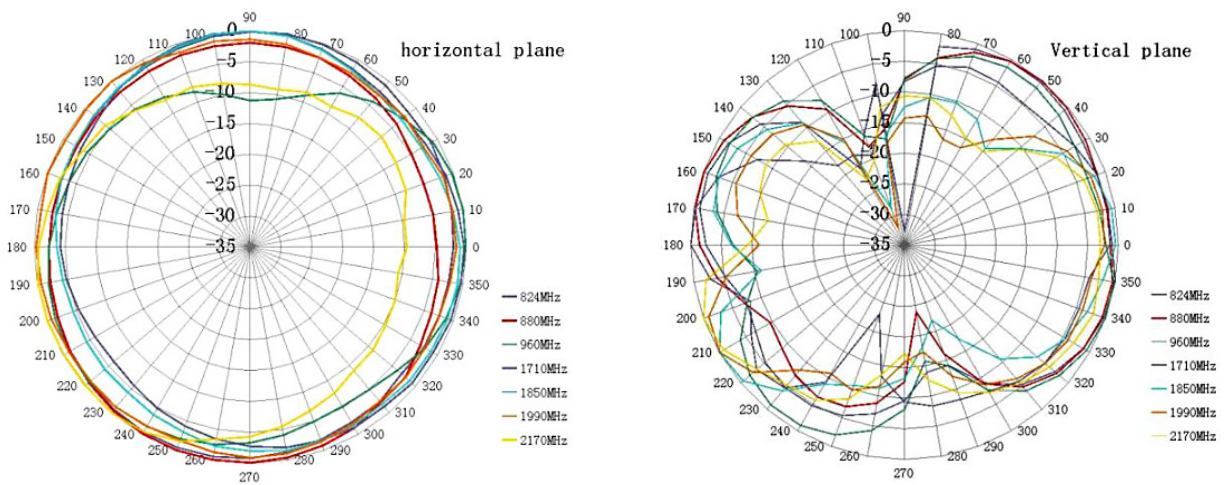

Ordering Details

Part number	Description
TANGO33/0.67M/SMAM/S/S/17	Thru-hole Quad Band 2G/3G Antenna