





Drawing No.	*Rev.	Date	Page
BF5H30G-YHR-100mA	B	2022/02/22	1/3

APPROVAL SHEET

Part No: **BF5H30G-YHR-100mA**

NOTE : Green Part

MAKER			CUSTOMER	
				
R&D	QA	Sales	Checked	Approved
				

Prepared	Checked	Approved
Rachel Lee	Sky Lin	Kenneth Wu

DESCRIPTION:

Device Type : BF5H30G-YHR-100mA
 Dice Material : AlGaAs
 Light Color : InfraRed 850nm
 Lens Color : Water Clear
 Lens Dimension : 5 mm

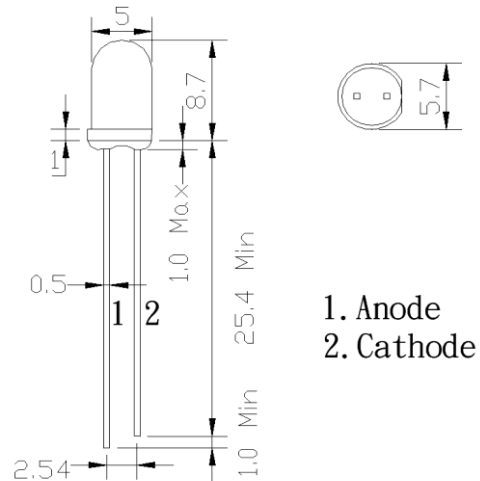

All epoxy resin dimension are in millimeter
tolerance is $\pm 0.2\text{mm}$

Absolute Maximum Ratings at $T_a=25^\circ\text{C}$

Parameter	Max.	Unit
DC Forward Current	120	mA
Reverse Voltage	5	V
Power Dissipation	240	mW
Operating Temperature	Topr : -40 ~ +85	$^\circ\text{C}$
Storage Temperature	Tstr : -40 ~ +100	$^\circ\text{C}$
Solder DIP (MAX. 5 seconds, 1.6mm from body) Temperature 260°C		

Electrical and Optical Characteristics at $T_a=25^\circ\text{C}$

Symbol	Description	Test Condition	Min.	Typ.	Max.	Unit
V_F	Forward Voltage	$I_F = 100\text{mA}$		1.6	2.0	V
IR	Reverse Current	$V_R = 5\text{V}$	-	-	10	μA
λ_P	Peak Emission Wavelength	$I_F = 100\text{mA}$	-	850	-	nm
$\Delta\lambda$	Spectral Line Halfwidth	$I_F = 100\text{mA}$	-	40	-	nm
$2\theta_{1/2}$	Viewing Angle	$I_F = 100\text{mA}$	-	30	-	Deg.
P_o	Radiant Power	$I_F = 100\text{mA}$	70	120	-	mW

- Note:
- 1.The lead should be formed up to 5mm from the body of device without forming stress.
 2. Soldering shall be performed after lead forming.
 3. All dimensions are in millimeters
 4. Suggestion: the better current for this device is less than 80mA.

LED LAMP Technical Data

Typical Optical-Electrical Characteristic Curves

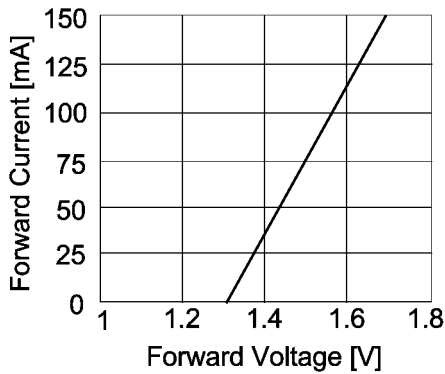

**Forward Current
Vs. Forward Voltage**

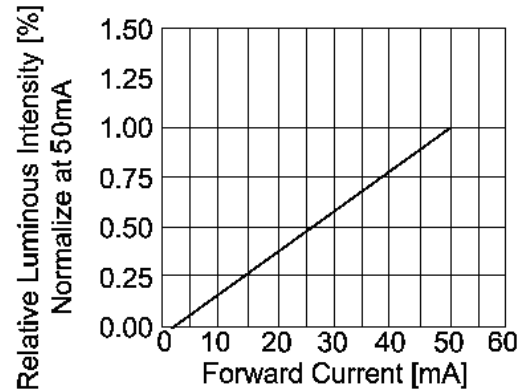

**Luminous Intensity
Vs. Forward Current**

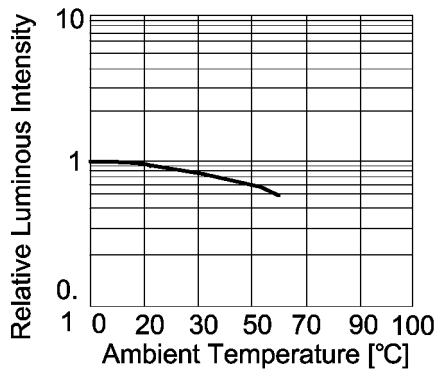

**Luminous Intensity
Vs. Ambient Temperature**

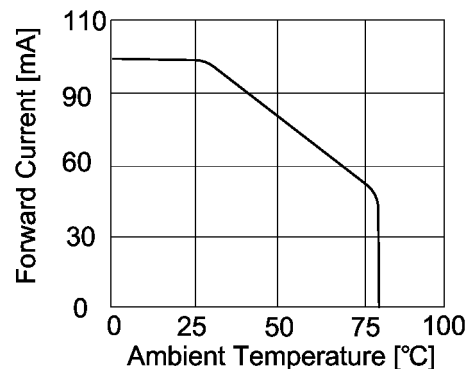

**Forward Current
Vs. Ambient Temperature**

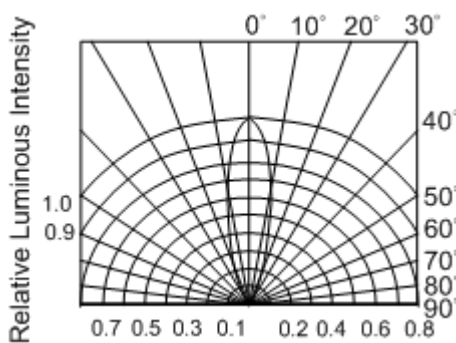

Radiation Pattern

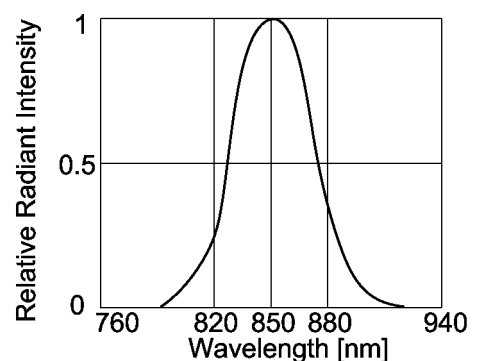

**Relative Luminous Intensity
Vs. Wavelength**