

F1500 RFI Filters

High Performance

SINGLE PHASE FILTERS



Features:

- IEC Connector Plus Common and Differential Mode Performance in Compact Case
- “L” Circuit Configuration — Cost-Effective in Many Linear and Switching Power Supply Applications
- High-Inductance Design for Greater Attenuation
- Available with 0.250" Quick Connect Terminals or Wire Leads on the Load Side

F1500AX/F1500CX Simplified Schematic

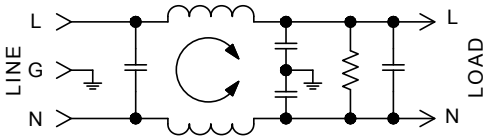

Specifications:

Rated Voltage: 250VAC Maximum - 50/60 Hz

Rated Current:	115VAC	250VAC
	3A	1.5A
	6A	3A
	10A	6A
	15A	8A

Current Overload: 6X for 8 seconds

Hi-Pot Test (1 min):

Line to Ground	1500VAC
Line to Line	1768VDC

Insulation Resistance: $9 \times 10^9 \Omega$ at 100VDC

Ambient Temperature: 40°C Max. at rated current

Humidity Range: 0% to 95% R.H.

Termination:

- A: QC – Quick Connect
- B: Wire
- C: IEC Receptacle
- F: IEC Receptacle with Fuse Holder

Maximum Leakage Current:

Each Line to Ground	F1500
115VAC, 60Hz:	0.25mA
250VAC, 50Hz:	0.40mA

Agency Approvals:



F1500FX Simplified Schematic

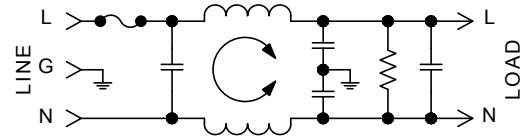

Nominal Current Rating	Part Number	Termination Line/Load	MINIMUM INSERTION LOSS - dB (50 ohm Circuit)						
			MODE	Frequency - MHz					
				.15	.50	1.0	5.0	10	30
3A	F1500AA03	QC/QC	Common Differential	32 35	43 60	50 65	50 60	50 55	50 40
	F1500CA03	IEC/QC							
	F1500FA03	Fused IEC/QC							
	F1500CB03	QC/Wire							
6A	F1500AA06	IEC/QC	Common Differential	32 30	42 60	45 65	45 65	45 60	45 50
	F1500CA06	Fused IEC/QC							
	F1500FA06	QC/Wire							
	F1500CB06								
10A	F1500AA10	QC/QC	Common Differential	29 15	36 50	39 65	45 65	45 60	45 50
	F1500CA10	IEC/QC							
	F1500FA10	Fused IEC/QC							
	F1500CB10								
15A	F1500CA15	IEC/QC	Common Differential	26 35	32 60	36 65	44 65	46 65	52 65
	F1500CB15	IEC/Wire							

NOTE: Other combinations of terminals may be specified on special order.



F1500AA (3 and 10Amp) Dimensions

Refer to Page 40
for Standard
Mounting Cutouts

Amps	A	B	C	D	E
3A	3.31 (84,1)	2.000 (50,8)	1.13 (28,7)	2.938 (74,6)	2.50 (63,5)
10A	3.31 (84,1)	2.000 (50,8)	1.50 (38,1)	2.938 (74,6)	2.50 (63,5)

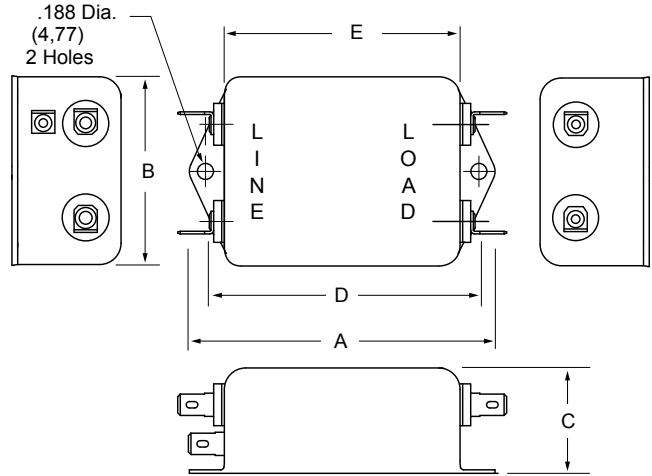

F1500CA (3, 6, 10 and 15Amp) Dimensions

F1500CB (3, 6, 10 and 15Amp) Dimensions

Refer to Page 40
for Standard
Mounting Cutouts

Amps	A	B	C	D	E
3A	2.000 (50,8)	2.000 (50,8)	1.500 (38,1)	.550 (14,0)	.565 (14,3)
6A	2.500 (63,5)	2.000 (50,8)	1.500 (38,1)	.550 (14,0)	.565 (14,3)
10A	2.500 (63,5)	2.000 (50,8)	1.500 (38,1)	.550 (14,0)	.565 (14,3)
15A	3.25 (82,6)	2.25 (57,2)	1.75 (44,5)	.550 (14,0)	.705 (17,9)

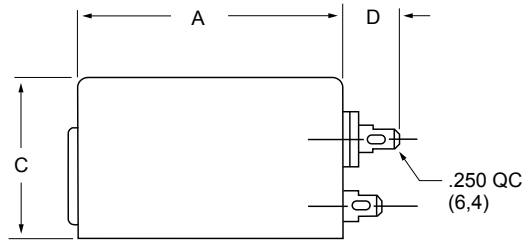
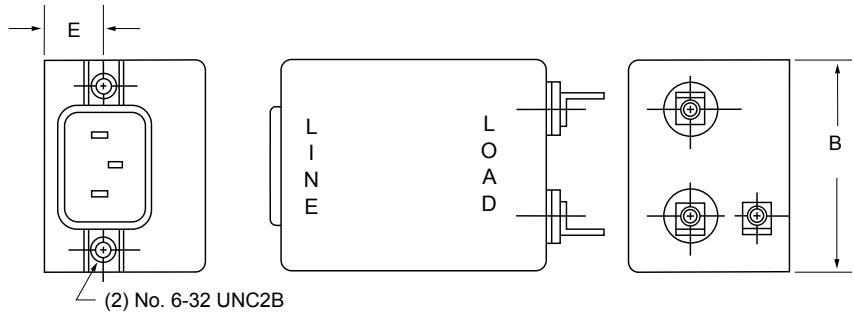

F1500FA (3, 6 and 10Amp) Dimensions

Refer to Page 40
for Standard
Mounting Cutouts

Amps	A	B	C	D	E
3A	2.000 (50,8)	2.000 (50,8)	1.500 (38,1)	.550 (14,0)	.752 (19,1)
6A	2.500 (63,5)	2.000 (50,8)	1.500 (38,1)	.550 (14,0)	.752 (19,1)
10A	2.500 (63,5)	2.000 (50,8)	1.500 (38,1)	.550 (14,0)	.752 (19,1)

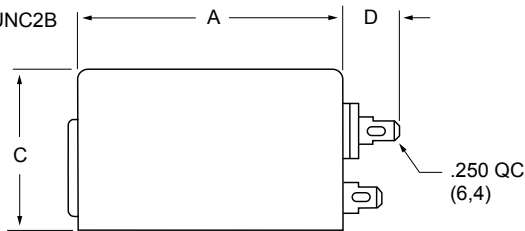
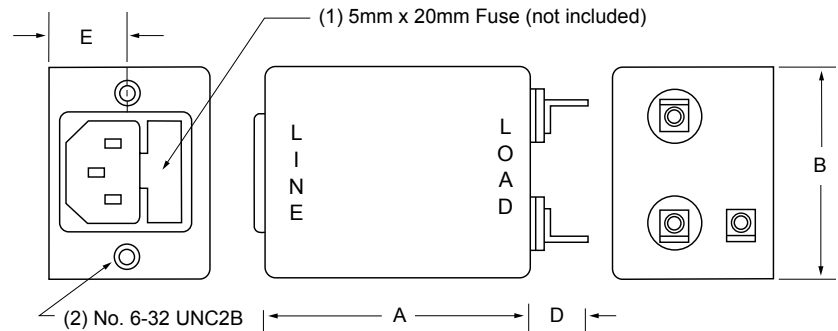

Standard Mounting Cutouts

F1200CA, F1300CA, F1400CA, F1500CA, F1600CA, F1700CA

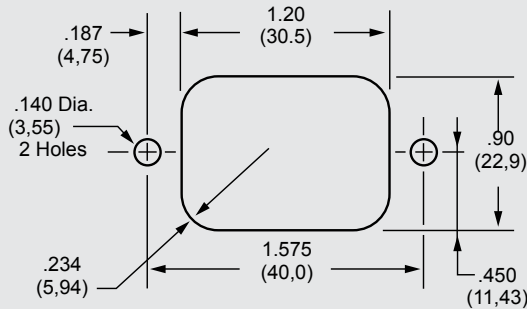

F1500FA, F1600FA,

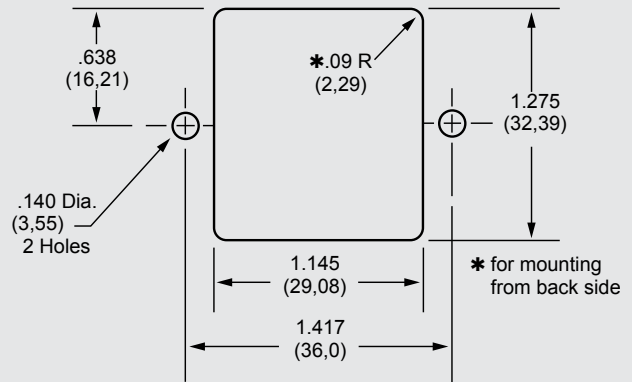

How to Order

The Curtis part numbering system is made up of four elements. Each element denotes a specific requirement (mechanical or electrical) which, when properly sequenced, fully identifies the required catalog filter. As shown, the first five alpha/numeric characters denote the series type; the sixth character (alpha) denotes the type of line termination; the seventh character (alpha) denotes the type of load termination; the last two characters (numeric) denote the current rating.

Compose your part number as follows: Select the series required, add two alpha character for the line and load termination, followed by two numeric characters for the required current rating. For example, F1100AB06 completely identifies an F1100 series filter with quick connects on line side and wire leads on load side, with a 6-amp rating.

F1300CP, F1600CP

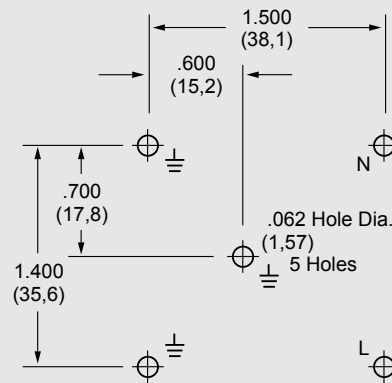

F5500/5600/5700 SERIES

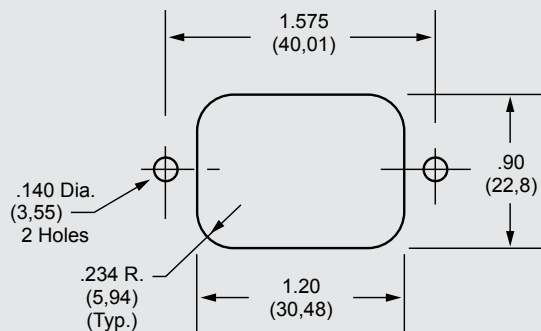

SINGLE PHASE FILTERS

F1100	X	X	X
SERIES	LINE TERMINATION	LOAD TERMINATION	CURRENT RATING
PE = Power Entry PM = Medical Power Entry	A = Quick Connects B = Wire Leads C = IEC Connector D = Screw Terminals (20 & 30 amp only) F = Fused IEC P = Printed Circuit Pins W = Dual Fused IEC J = Switched IEC	A = Quick Connects B = Wire Leads D = Screw Terminals (20 & 30 amp only) P = Printed Circuit Pins S = Solder Tab	01 = 1 Amp 03 = 3 Amps 06 = 6 Amps 10 = 10 Amps 15 = 15 Amps 20 = 20 Amps 30 = 30 Amps

