

THIS DOCUMENT IS SUBJECT TO CHANGE WITHOUT NOTICE. IT IS CONFIDENTIAL AND A PROPERTY OF Amphenol LTW. DISCLOSURE TO THIRD PARTY HAS TO BE AUTHORIZED BY Amphenol LTW.

REV.	ECN NO.	DATE	SIGN	DESCRIPTION
B		2018/10/23	Brady	Add Dimension
C		2019/03/05	Brady	Modify Tolerance
D	BOMR19120084	2019-12-14	Peng	$\triangle$ X4

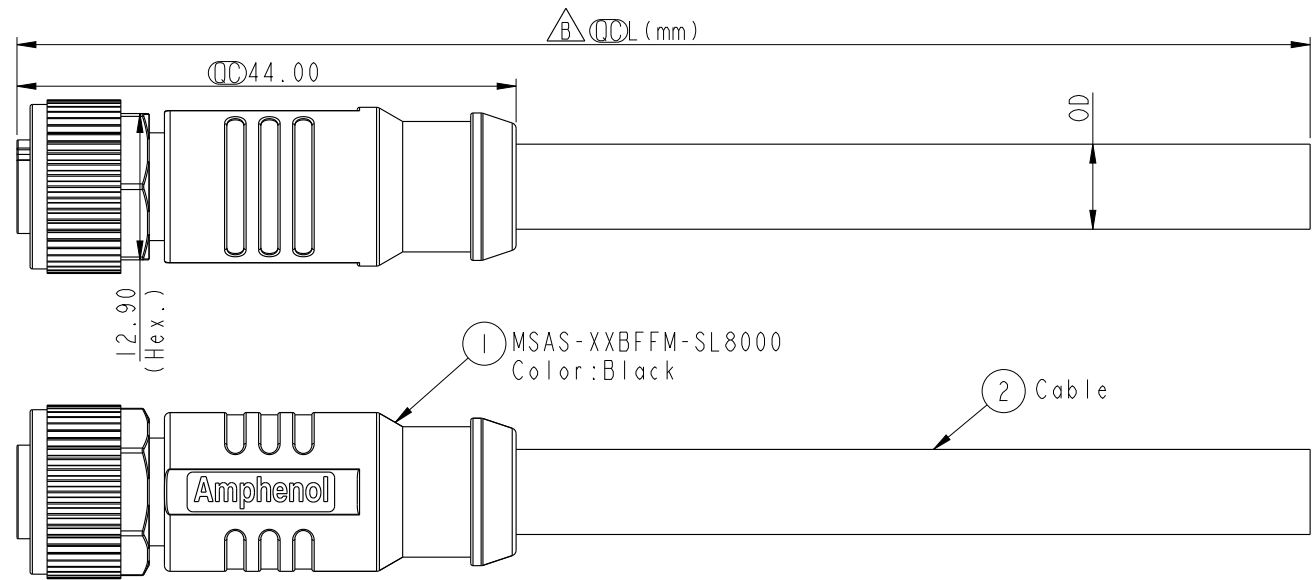

$\triangle$  Notes:

- \*  $\text{\textcircled{C}}$  Important Dimension.
- \* Waterproof Rate: IP68(Under water 1M for 24Hrs).
- \* Connector: 3~6Pin,8Pin,10Pin,12Pin:Nylon+GF, Black.  
17Pin:Thermoplastic, Black.
- \* Female Pin: Copper Alloy, Gold Plated.
- \* Screw Nut: Zinc Alloy, Nickel Plated.
- \* Outer Mold: PP, Black.
- \* Cable: (B) UL20549,Shield, PU Jacket, Black  
(D) UL2517, Shield, PVC Jacket,UV resistant. Black.
- \* Rated Voltage: 3 & 4Pin 250V dc. or ac.  
5Pin 60V dc. or ac.  
6~12Pin,17Pin. 30V dc. or ac.
- \* Rated Current: 3~5Pin 4A  
6~8Pin 2A  
10~12Pin,17Pin. 1.5A
- \* Operating Temperature: -25~85°C

- \* Cable Length Tolerance: 01M $\pm$ 40mm  
02~05M: $\pm$ 60mm  
06~10M: $\pm$ 100mm  
11~30M: $\pm$ 200mm  
31~30M: $\pm$ 500mm

UNIT:mm		
TOLERANCE	$\pm 0.5\text{mm}$	

TITLE M12 Shielded A Code Cable Female Conn.		
SCALE 3:2	SIZE A4	SHEET 1 OF 3
REV. D	WC-REV. A.3	$\text{\textcircled{C}}$ : Inspection item

**Amphenol LTW**  
安費諾亮泰企業股份有限公司

ITEM NO	DRAWN BY Brady	DATE 2019/03/05
DWG NO MSAS-XXBFFM-SL8XXX	CHECKED BY Eagle	DATE 2019/03/05
CUSTOMER ALTW	APPROVED BY Neo	DATE 2019/03/05

THIS DOCUMENT IS SUBJECT TO CHANGE WITHOUT NOTICE. IT IS CONFIDENTIAL AND A PROPERTY OF Amphenol LTW. DISCLOSURE TO THIRD PARTY HAS TO BE AUTHORIZED BY Amphenol LTW.

1 2 3 4 5 6 7 8

F

E

D

C

B

A



17P	PU	7.5	26	MSAS-17BFFM-SL8BXX
12P		6.4	26	MSAS-12BFFM-SL8BXX
8P		5.8	24	MSAS-08BFFM-SL8BXX
5P		5.7	22	MSAS-05BFFM-SL8BXX
17P	PVC	7.5	26	MSAS-17BFFM-SL8DXX
12P		6.4	26	MSAS-12BFFM-SL8DXX
8P		5.8	24	MSAS-08BFFM-SL8DXX
5P		5.7	22	MSAS-05BFFM-SL8DXX
Contacts	Cable Jacket	Cable OD	AWG	Item No.

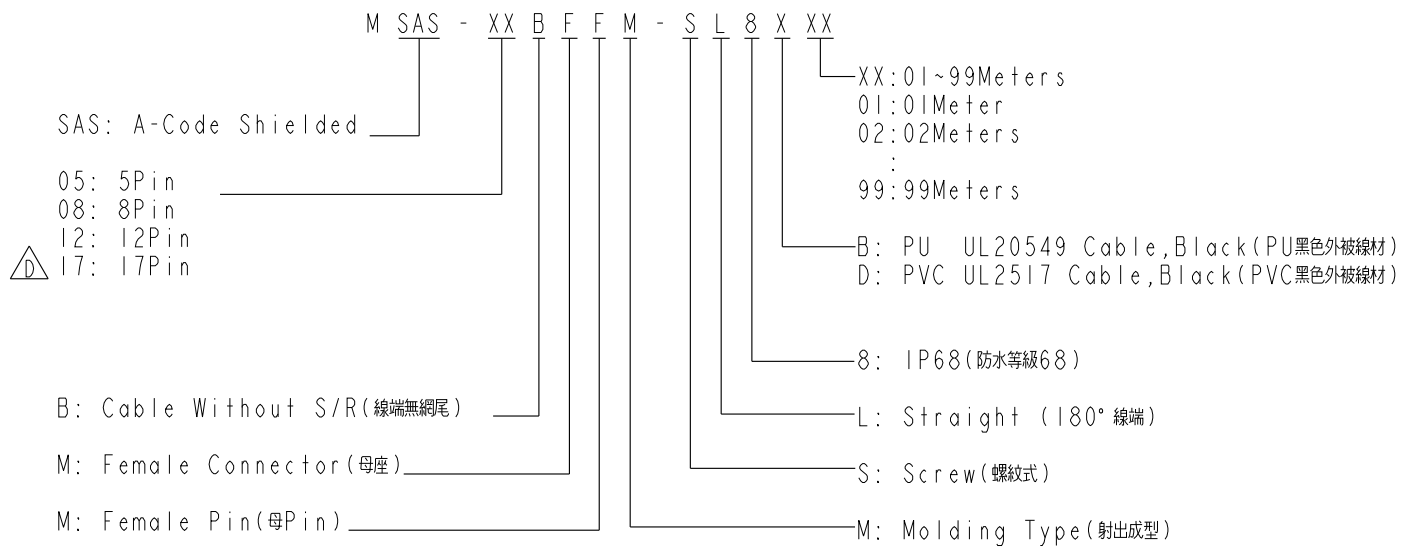

UNIT: mm

TOLERANCE





±0.5mm

TITLE M12 Shielded A Code Cable Female Conn.			
SCALE 3:2	SIZE A4	SHEET 2 OF 3	
REV. D	WC-REV. A.3	QC: Inspection item	

**Amphenol LTW**  
安費諾亮泰企業股份有限公司

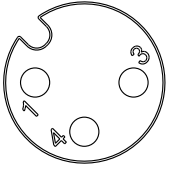
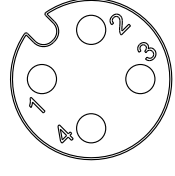
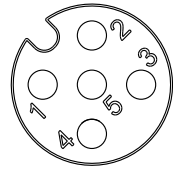
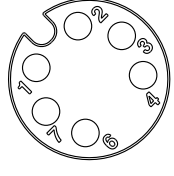
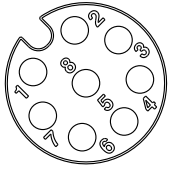
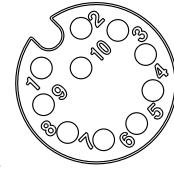
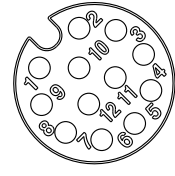
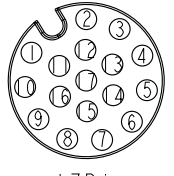
ITEM NO	DRAWN BY Brady	DATE 2019/03/05
DWG NO MSAS-XXBFFM-SL8XXX	CHECKED BY Eagle	DATE 2019/03/05
CUSTOMER ALTW	APPROVED BY Neo	DATE 2019/03/05

1 2 3 4 5 6 7 8 W10814-03-201A2

F										
E										
D	△△△							△		
C	Shield Braid	Shield Braid	Shield Braid	Shield Braid	Shield Braid	Shield Braid	Shield Braid	Shield Braid	Shield Braid	
	5 --	5 --	5 Gray 灰	5 --	5 Gray 灰	5 --	5 Gray 灰	5 Gray 灰	5 Gray 灰	
	4 Black 黑	4 Black 黑	4 Black 黑	4 Yellow 黃	4 Yellow 黃	4 Yellow 黃	4 Yellow 黃	4 Yellow 黃	4 Yellow 黃	
	3 Blue 藍	3 Blue 藍	3 Blue 藍	3 Green 綠	3 Green 綠	3 Green 綠	3 Green 綠	3 Green 綠	3 Green 綠	
	2 --	2 White 白	2 White 白	2 Brown 棕	2 Brown 棕	2 Brown 棕	2 Brown 棕	2 Brown 棕	2 Brown 棕	
	1 Brown 棕	1 Brown 棕	1 Brown 棕	1 White 白	1 White 白	1 White 白	1 White 白	1 White 白	1 White 白	
	Pin # Wire	Pin # Wire	Pin # Wire	Pin # Wire	Pin # Wire	Pin # Wire	Pin # Wire	Pin # Wire	Pin # Wire	
B	Pin Out									
										
	3P	4P	5P	6P	8P	10P	12P	17Pin		
A	Pin Assignments- Front View									
	UNIT:mm			TITLE M12 Shielded A Code Cable Female Conn.			ITEM NO		DRAWN BY	DATE
	TOLERANCE ±0.5mm			SCALE 3:2	SIZE A4	SHEET 3 OF 3	DWG NO MSAS-XXBFFM-SL8XXX		CHECKED BY	DATE
				REV. D	WC-REV. A.2	 Inspection item	CUSTOMER ALTW		APPROVED BY	DATE
							Brady		2019/03/05	
							Eagle		2019/03/05	
							Neo		2019/03/05	
	1	2	3	4	5	6	7	8	W10814-03-001A2	

**Amphenol LTW**  
安費諾亮泰企業股份有限公司