

CODE	DIM "M" MATING LENGTH	CONTACT TYPE
U	[6.86]	SIGNAL
T	[6.86]	SIGNAL
S	[6.86]	SIGNAL
R	[6.86]	SIGNAL
PA	[N/A]	POWER
HA	[N/A]	HOLD-DOWN

spec ref	*	dr	Ruan MT	2014/05/29	projection	MM	size	A4	scale	1:1
tolerance std	ASME Y14.5	eng	Luo Weller	2014/11/05		←→	ecn no	-	rel level	Released
TOLERANCES UNLESS OTHERWISE SPECIFIED		chr	-	-						
surface	✓	appr	Pei-Ming Zheng	2014/11/05	product family	PwrBlade	rev			
ASME Y14.5	linear	0.X	±0.5		title	6P + 32S + 6P	dwg no	51939-888	A	rev
		0.XX	±0.25		RIGHT ANGLE STB HEADER					
		0.XXX	±0.1							
	angular	0°	±2°	www.fci.com	cat. no.	-	Product - Customer Drw	sheet 1 of 4		



Copyright FCI.

PrdE File - REV C - 2009-06-09

PRODUCT NUMBER

51939-888--
NOTE: 3

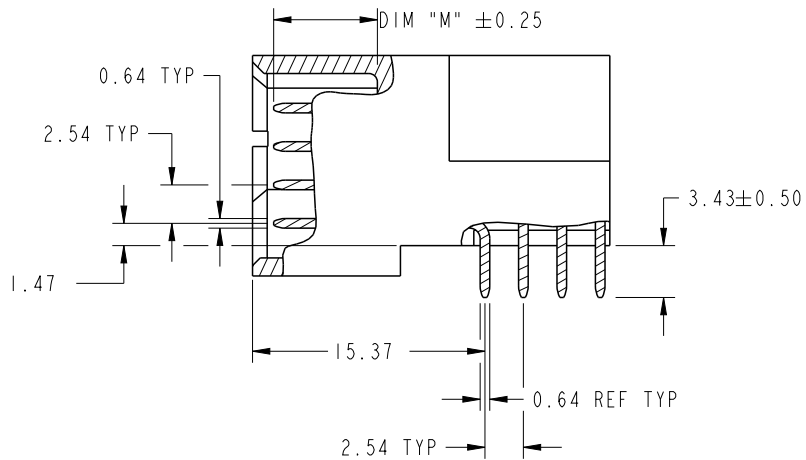

BROKEN-OUT SECTION A-A
SCALE 2:1

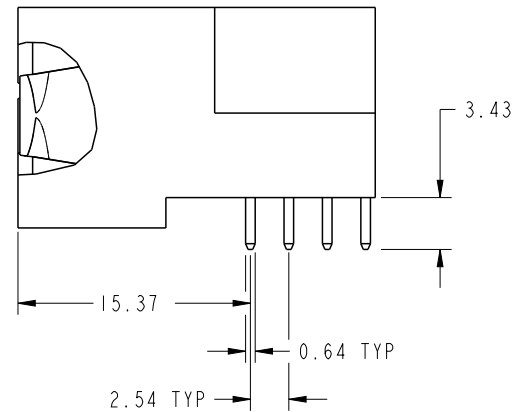

BROKEN-OUT SECTION B-B
SCALE 2:1

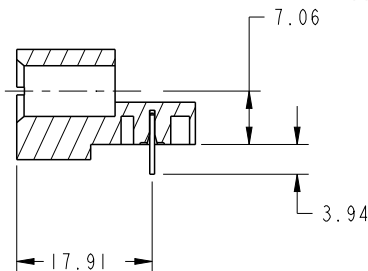

SECTION C-C

dr	Ruan MT	2014/05/29	projection 	MM 	size	A4	scale	1:1
eng	Luo Weller	2014/11/05			ecn no	-		
chr	-	-			rel level	Released		
appr	Pei-Ming Zheng	2014/11/05	product family	PwrBlade	rev	A		
	title	6P + 32S + 6P		dwg no	51939-888			
www.fci.com	cat. no.	-		Product - Customer Drw	sheet 2 of 4			
			RIGHT ANGLE STB HEADER					

PRODUCT NUMBER

51939-888__
NOTE: 3

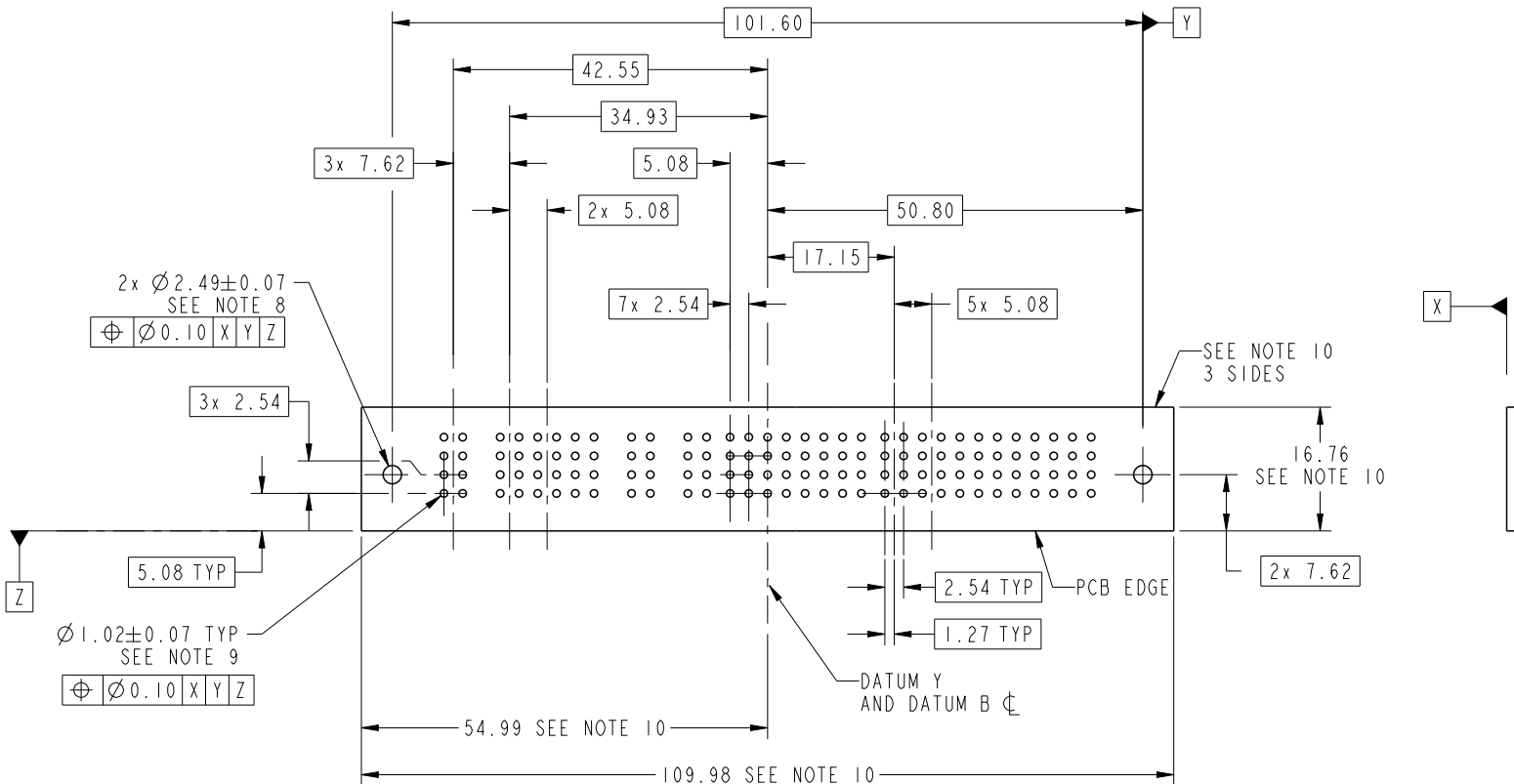

RECOMMENDED PCB LAYOUT

dr	Ruan MT	2014/05/29	projection 	MM 	size	A4	scale	1:1
eng	Luo Weller	2014/11/05			ecn no	-		
chr	-	-			rel level	Released		
appr	Pei-Ming Zheng	2014/11/05	product family	PwrBlade	rev	A		
	title	6P + 32S + 6P RIGHT ANGLE STB HEADER		dwg no	51939-888			
www.fci.com	cat. no.	-	Product - Customer Drw		sheet 3 of 4			

PRODUCT NUMBER

51939-888__
NOTE: 3

NOTES:



1. DIMENSIONS AND TOLERANCES ARE IN ACCORDANCE WITH ASME Y14.5M, 1994 UNLESS OTHERWISE SPECIFIED.

CONNECTOR NOTES:

- 2. HOUSING MATERIAL: UL 94 V-0 GLASS FILLED HIGH-TEMP THERMOPLASTIC
POWER CONTACT MATERIAL: COPPER ALLOY
SIGNAL PIN MATERIAL: COPPER ALLOY
- 3. SEE ITEM 1 & 2 IN PRINT 10064183 FOR PLATING SPEC OF 51939-888 AND 51939-888LF RESPECTIVELY.
- 4. MANUFACTURER'S NAME, DATE CODE AND OPTIONAL P/N TO APPEAR ON THIS SURFACE. THE MARK CAN BE OMITTED IF THERE IS NOT ENOUGH SPACE ON THIS SURFACE.
- 5. PRODUCT SPECIFICATION GS-12-149.
APPLICATION SPECIFICATION BUS-20-067.
- 6. PACKAGED IN TRAYS.

PCB NOTES:

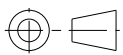
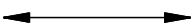
- 7. ALL HOLE DIAMETERS ARE FINISHED HOLE SIZE.
- 8. MOUNTING HOLES, WHERE APPLICABLE, ARE UNPLATED.
- 9. $\varnothing 1.151 \pm 0.025$ DRILLED HOLES PLATED WITH
0.008 MIN SnPb OR Sn OVER 0.03
TO 0.08 Cu PLATING TO ACHIEVE
 $\varnothing 1.02 \pm 0.07$ HOLE.
- 10. CONNECTOR KEEP-OUT ZONE.

dr	Ruan MT	2014/05/29	projection 	MM 	size	A4	scale	1:1
eng	Luo Weller	2014/11/05			ecn no	-		
chr	-	-			product family	PwrBlade	rel level	Released
appr	Pei-Ming Zheng	2014/11/05			title	6P + 32S + 6P RIGHT ANGLE STB HEADER		dwg no 51939-888 rev A
www.fci.com		cat. no.	-	Product - Customer Drw			sheet 4 of 4	



Copyright FCI.