

## AB-GES-L08106Wxx4T1

### Features:

- 6W Linear AC LED light engine
- SimpleDrive® - 120V AC drive technology
- Max Qty in series: 20
- Driver on Board structure
- Long life - No Electrolytic capacitors
- Easily integrated

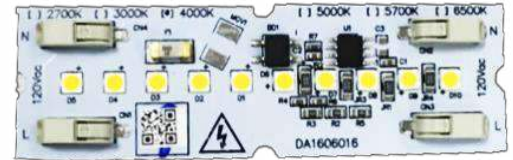
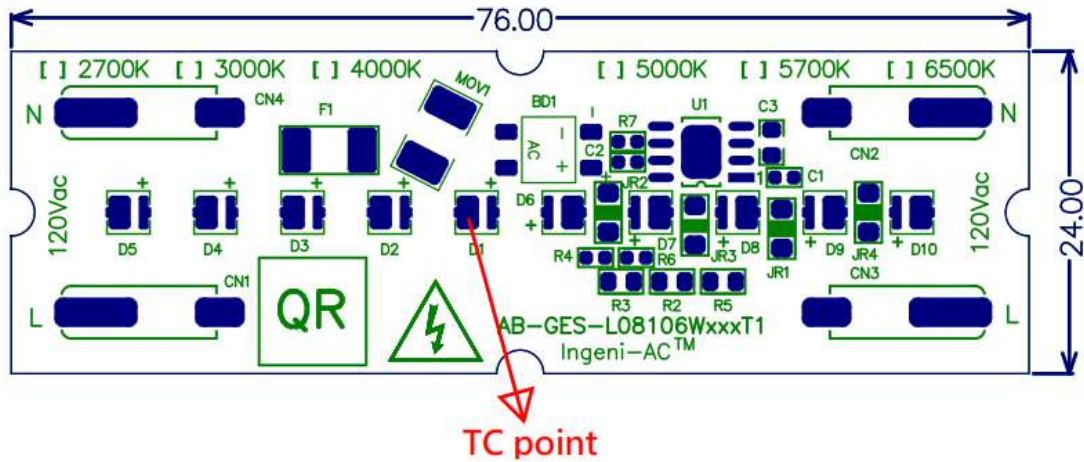

Figure: AC Module

### Applications:

- Refrigerator light
- Under-cabinet
- Ceiling light
- Wall Sconces
- Cove light
- Wall wash
- Graphic backlight





10 LEDs

Units: mm

Notes:

1. 4 individual connectors, 2 on each end, are used for the serial connection and No wire connected.
2. Thickness of PCB is 1.2mm. Thermal tape on the back side of module
3. Tolerance of dimension is  $\pm 0.15$ mm
4. Please use plastic screw for passing the safety regulation.
5. IMPORTANT: In order to pass UL1598, add an insulating thermal pad with at least 1.0mm thickness to the module.



## Characteristics

### Absolute Maximum Ratings

Parameter	Symbol	Rating	Unit
Input Voltage	V <sub>in</sub>	130	Vac
LED Junction Temperature <sup>[2]</sup>	T <sub>j</sub>	115	°C
Storage Temperature	T <sub>stg</sub>	-40 ~ 85 °C	°C
Operation Temperature	T <sub>opr</sub>	-40 ~ 85 °C	°C

- Proper current rating must be observed to maintain junction temperature below maximum at all time. For this product, we suggest to keep the Temperature of TC point under 75°C, and the temperature of Top IC surface under 110°C. After passing the maximum temperature of IC, the rating current will be lower automatically for protecting the whole circuit.

### Electrical Characteristics, Ta=25°C

Parameter	Symbol	Min.	Typ.	Max.	Unit
Input Voltage	V <sub>in</sub>	110		130	Vac
Input Frequency	Freq.	50/60			Hz
Power Factor	PF	0.9		0.95	-
Flicker % <sup>[1]</sup>		100%			
Flicker Index <sup>[1]</sup>		0.3			

- Surge protection is up to 0.5KV

### Optical Characteristics (V<sub>in</sub>=120V), Ta=25°C

Model name	AC Power(W)			Color Temp (K)	Luminous Flux(lm)		CRI
	Min	Typ.	Max		Min	Typ	
AB-GES-L08106W304T1	5.6	6.0	6.8	3000	530	600	>80
AB-GES-L08106W404T1	5.6	6.0	6.8	4000	580	630	>80
AB-GES-L08106W504T1	5.6	6.0	6.8	5000	580	630	>80

- Correlated color temperature is derived from the CIE 1931Chromaticity diagram.
- The luminous flux tolerance is ± 10%.
- This CRI value tolerance is ± 2.
- Calibration accuracy of CIE<sub>x</sub> and CIE<sub>y</sub> : ±0.007 ;
- Calibration error CCT 3000K ±175K ; 4000K ±300K ; 6500K ±400K

### Thermal Resistance, Ta=25°C

Part	Min.	Typ.	Max.	Unit
LED		12		°C/W
IC	15		20	°C/W

■ **Relative Spectrum of Emission (Ta=25°C, Test current=60mA)**

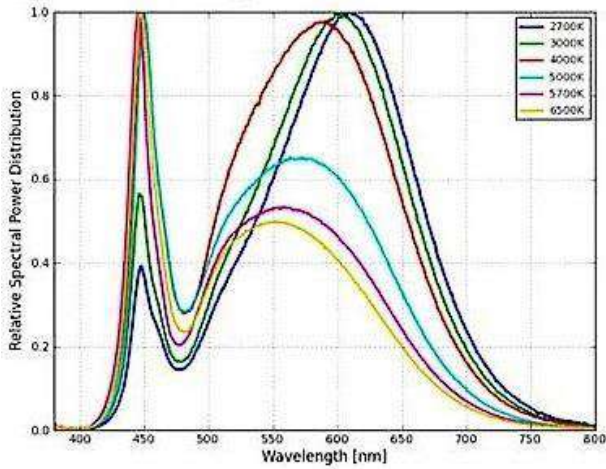

■ **Radiation Pattern (Tj=25 °C)**

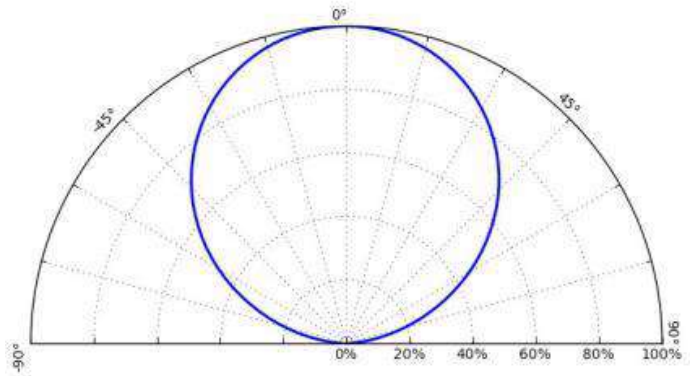

■ **Relative power distribution vs. Input voltage (Ta=25°C)**

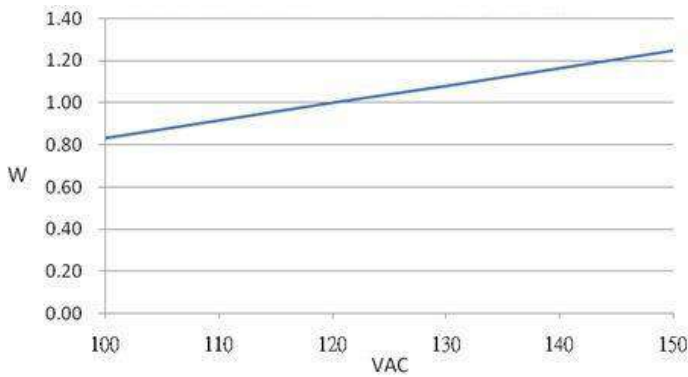

■ **Relative luminous output vs. Input voltage (Ta=25°C)**

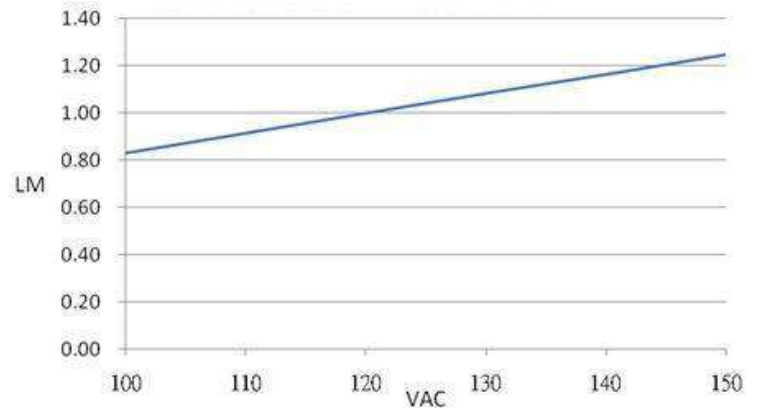

■ **Conduction Testing<sup>[4]</sup> 1 (120Vac/60Hz)**

Standard: EN 55015 (QP), Temp. (C)/Hum.(%): 25°C/57%

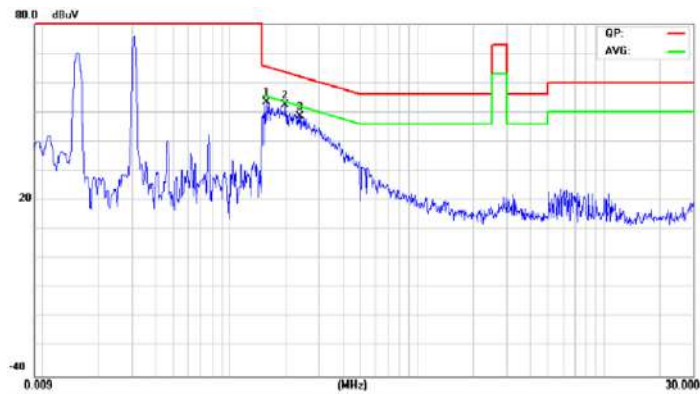

■ **Conduction Testing<sup>[4]</sup> 2 (120Vac/60Hz)**

Standard: EN 55015 (QP), Temp. (C)/Hum.(%): 25°C/57%

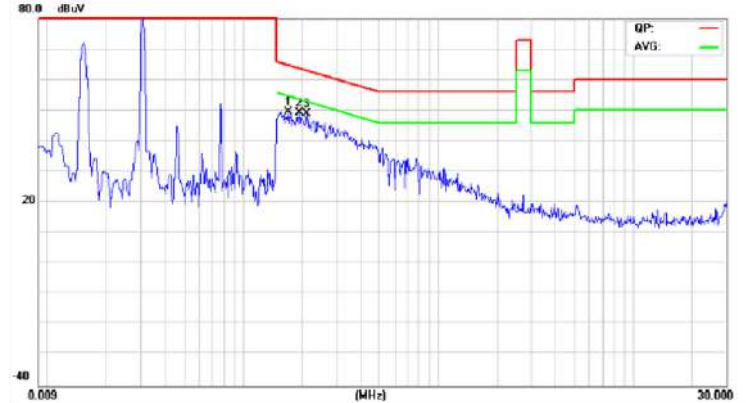

## Packaging

1. ESD bubble bag

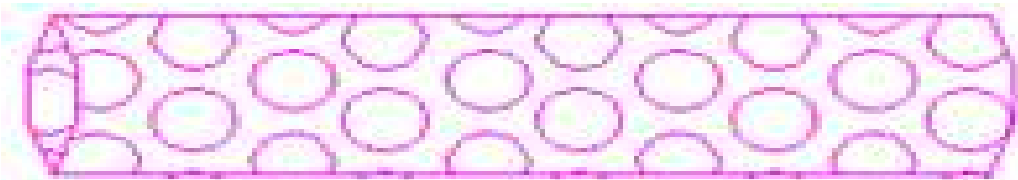
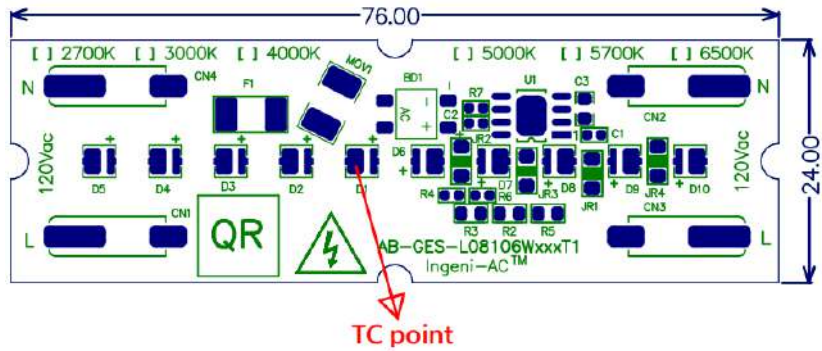

- 2 items per bag
- 1 Box = 200 PCS (about 4 Kgs)

## Color Bin Code

Color region stays within Macadam "3-Step" ellipse from the chromaticity center.  
 The chromaticity center refers to ANSI C78.377:2008.

Please refer to ANSI C78.377 for the chromaticity center.

CC	Steps	C	C	a	b	theta
2700K	3	0.4578	0.4101	0.00810	0.00420	53.7
3000K	3	0.4338	0.4030	0.00834	0.00408	53.2
3500K	3	0.4073	0.3917	0.00927	0.00414	54.0
4000K	3	0.3818	0.3797	0.00939	0.00402	53.7
5000K	3	0.3447	0.3553	0.00822	0.00354	59.6
5700K	3	0.3287	0.3417	0.00746	0.00320	59.0
6500K	3	0.3123	0.3282	0.00669	0.00285	58.5

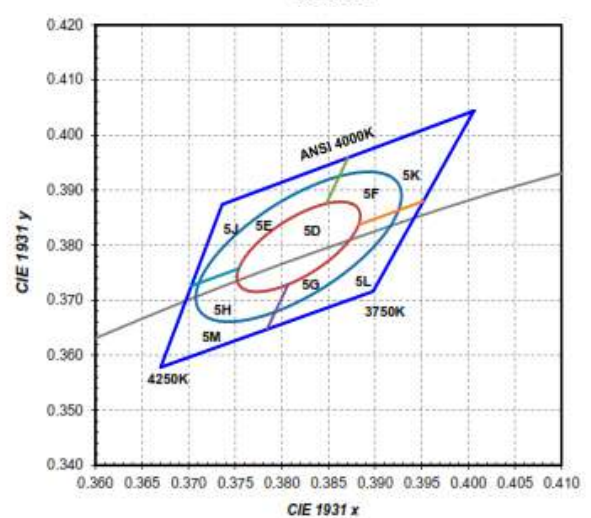
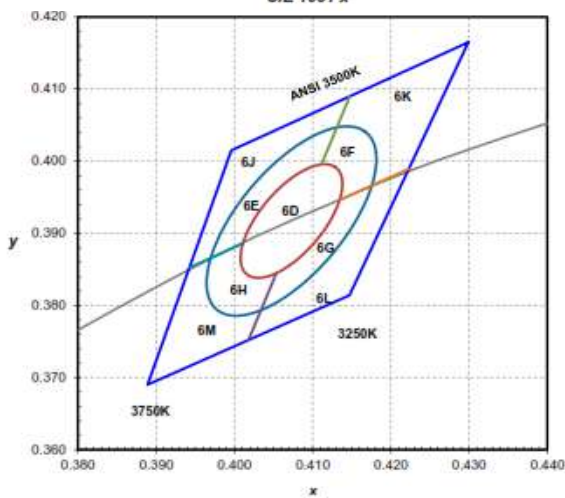
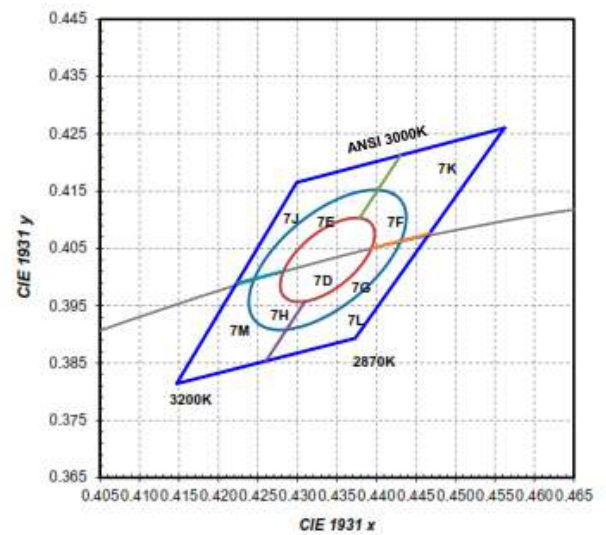
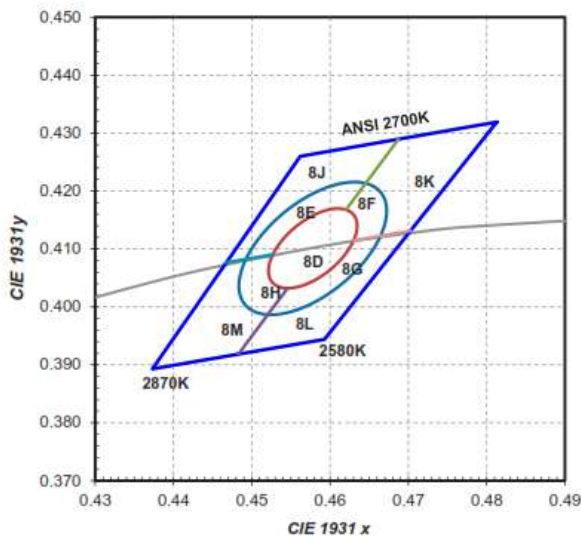

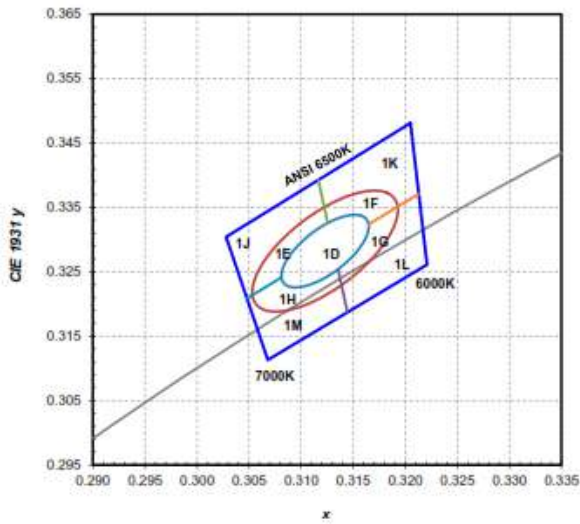
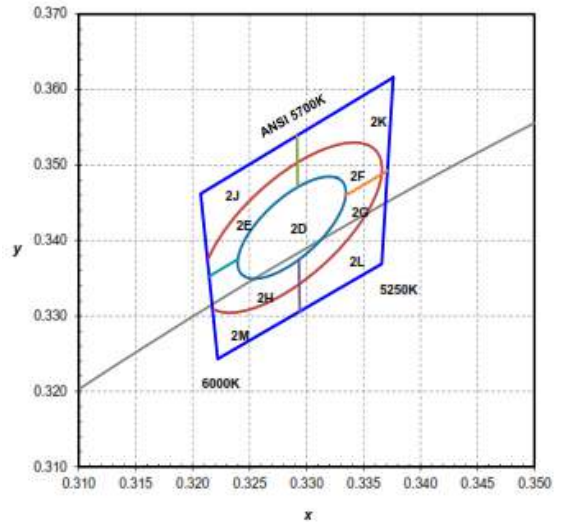
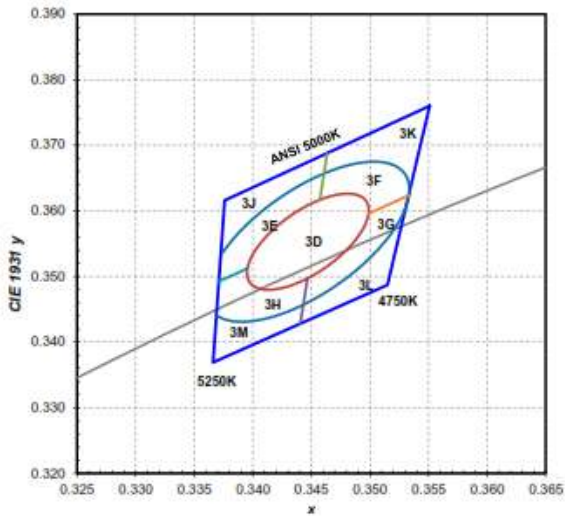

## AC Module Flicker

Flicker for AC driven LED modules can be measured in two different manners, Percent and Index.

**Percent** - Older more common metric that measures peak to peak amplitude. No other attributes of the AC wave are taken into account. Measurements of percent range from 0%-100%

AC Module Flicker	100%
Any LED system with Electrolytic Capacitor	2%-90%

**Index** - A metric defined by the IES (Illuminating Engineering Society) that measures the shape, duty cycle, and peak to peak amplitude. This is a true measure of eye response to flicker. Measurement of index range form 1-1.0.

AC Module Index	<0.3
Any LED system with Electrolytic Capacitor	.02~0.2

Graph showing measurement differences

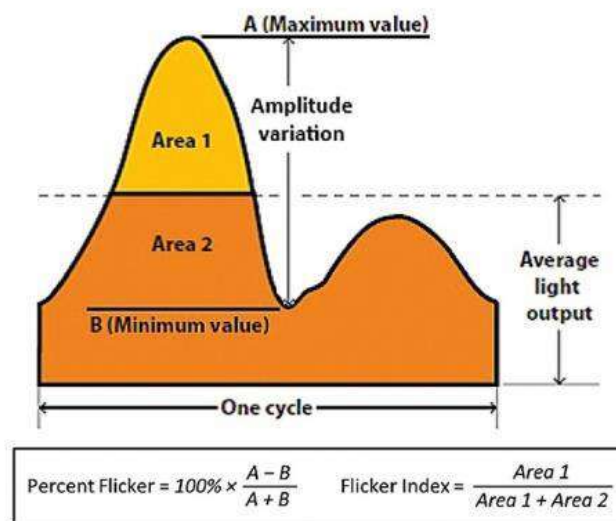



## Junction Temperature ( $T_j$ ) & $T_c$ Point

Junction Temperature is the most important factor of LED. Different life performance will be impacted by different junction temperature.

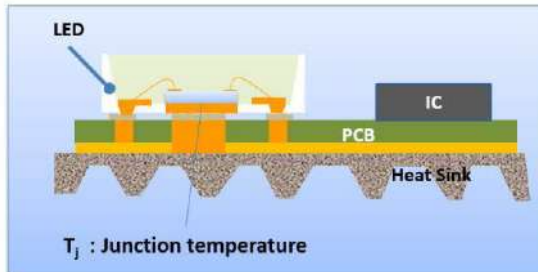

If the thermal dissipation is good enough, the junction temperature will be lower and the lifetime performance will be better.

If the junction temperature is higher than  $120^{\circ}\text{C}$ , the LED will deteriorate quickly.

### How to monitor the junction temperature?

You need to measure the  $T_c$  point.

Each AC LED module has one  $T_c$  point, which is set up for monitoring the operating temperature and junction temperature of the LED.

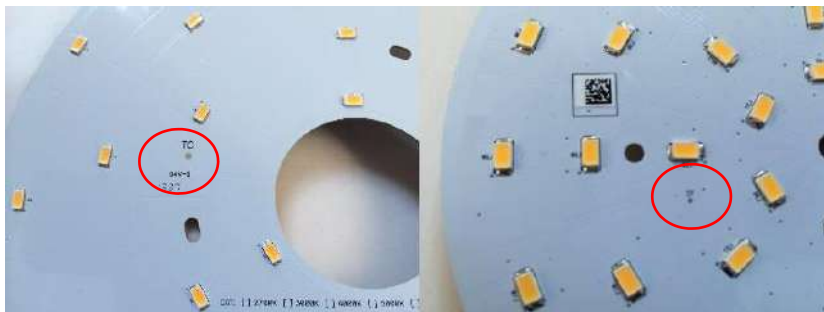

You can use the high-temperature thermal conductivity glue (Such as SatlonD-3/606...etc.) to fix the thermal couple to the  $T_c$  point then measure the temperature. Once you got the  $T_c$  temperature measurement data, you can calculate the junction temperature based on the measurement data of the  $T_c$ .



**Backside of AC LED module**

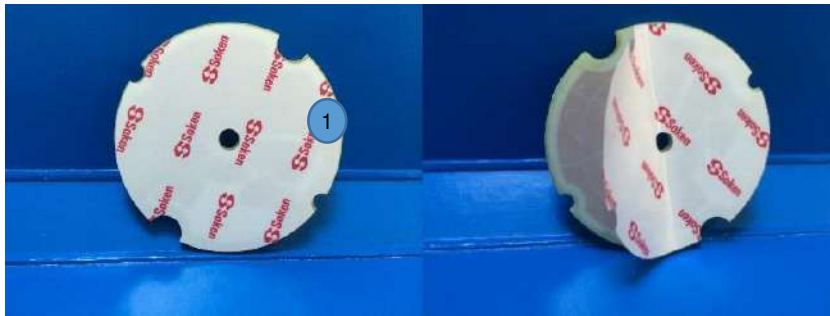

**Picture of the backside of module**

**Items:**

**Warning:**  
Remember to remove the protective paper on the thermal insulating tape from the backside of the module

**Warning:**  
AC LED modules must be attached by an additional connection, not only the tape

**Specification of the Thermal tape**

**HS-6250(B25)**



<b>Thickness</b>	mm	0.25
<b>Adhesive force</b>	T <sub>0</sub> (0 hrs)	4.0
	T <sub>24</sub> (24 hrs)	4.6
<b>Thermal conductivity</b>	W / m •K	0.7
<b>Thermal resistance</b>	cm <sup>2</sup> °C/W	3.6
<b>Fire ret ardency</b>	UL94	V0
<b>Isolation strength</b>	DC (kV)	>10
	AC (kV)	4.4

## Installation Instructions

**Installation:**

1. Remove the protective paper on the back side of AC LED module
2. Adjust the AC LED module to the desired position
3. Using a screw driver, attach the AC LED module
4. Select the proper wire

If a connector is going to be used with the AC Module, please follow the instructions below

	WAGO	BJB
Photo		
Conductor size	Solid: 0.2-0.75mm <sup>2</sup> Fine stranded: 0.2-0.75mm <sup>2</sup>	Solid: 0.34-0.75mm <sup>2</sup>
Conductor size (AWG)	18-24	18-24

**Connector spec summary**



## Reference Information

- [1] Flicker information, please refer to page 8.
- [2] Junction Temperature (Tj) & Tc Point information please refer to page 9.
- [3] Thermal tape information, please refer to page 10.
- [4] The primary goal of **EMC testing** is to identify the sources of electromagnetic energy emitted from an electronic device in an effort to reduce potential interference to other equipment, as well as determine the susceptibility of the equipment from electromagnetic energy emitted from other electronic devices nearby.



## Warranty

American Bright Optoelectronics Corp., warrants that its AC LED MODULES will be free from defects in material and workmanship from the date of manufacture by American Bright Optoelectronics Corp. for a period of 5 years (LED light generation module case temperature(s) not to exceed 75°C, IC temperature(s) not to exceed 110°C). The AC LED MODULES consists of a LED lighting components and the driver circuit (collectively, the "Power circuit"). This limited warranty only applies when the American Bright Optoelectronics Corp. LED module is properly connected and installed on the luminaire; operated within the electrical values recommended by American Bright Optoelectronics Corp.; and used in situations approved for the application and in the environmental conditions (temperature, humidity) within the normal specified operating range of the system.

This warranty is further conditioned upon proper storage, installation, use and maintenance. This warranty is not applicable to any Product which is not installed and operated in accordance with the current edition of The National Electric Code (NEC), the Standards for Safety of Underwriters' Laboratory, Inc. (UL), the Standards for the American National Standards Institute (ANSI), and with American Bright Optoelectronics Corp.'s instructions and guidelines for the Product. This warranty is not applicable to any Product or component subjected to abnormal stresses and operating conditions. Replacement of the American Bright Optoelectronics Corp. Product with LED components of other manufacturers will void the entire warranty.

THE WARRANTIES AND REMEDIES SET FORTH HEREIN ARE EXCLUSIVE AND IN LIEU OF ALL OTHER WARRANTIES WHETHER, EXPRESS OR IMPLIED, INCLUDING ALL WARRANTIES OF MERCHANTABILITY AND FITNESS FOR A PARTICULAR PURPOSE AND ALL WARRANTIES ARISING FROM COURSE OF DEALING OR USAGE OR TRADE. Purchaser's exclusive remedy, for any nonconformity or defect in any product shall be only those explicitly set forth herein.