

RECOMMENDED PCB(CONNECTOR SIDE VIEW)  
THICKNESS=1.6 TO 2.4 MM

ONLY FOR CKT 6, 10, 14  
OTHER DIMENSIONS REFER TO LEFT VIEWS.

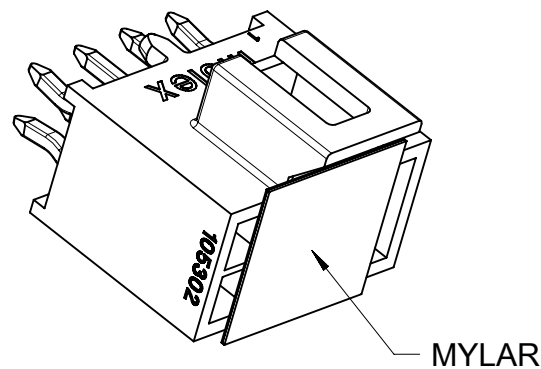

FUNCTIONAL SYMBOLS	THIS DRAWING CONTAINS INFORMATION THAT IS PROPRIETARY TO MOLEX ELECTRONIC TECHNOLOGIES, LLC AND SHOULD NOT BE USED WITHOUT WRITTEN PERMISSION	CURRENT REV DESC:																							
	<table border="1"> <tr> <th>DIMENSION UNITS</th> <th>SCALE</th> </tr> <tr> <td>mm</td> <td>5:1</td> </tr> </table>	DIMENSION UNITS	SCALE					mm	5:1	<table border="1"> <tr> <td>EC NO: 698973</td> <td>2022/03/07</td> </tr> <tr> <td>DRWN: GLLI</td> <td>2022/03/11</td> </tr> <tr> <td>CHK'D: XQZHANG</td> <td>2022/03/11</td> </tr> <tr> <td>APPR: XQZHANG</td> <td>2022/03/11</td> </tr> </table>		EC NO: 698973	2022/03/07	DRWN: GLLI	2022/03/11	CHK'D: XQZHANG	2022/03/11	APPR: XQZHANG	2022/03/11	<table border="1"> <tr> <td>GENERAL TOLERANCES (UNLESS SPECIFIED)</td> <td></td> </tr> <tr> <td>ANGULAR TOL</td> <td><math>\pm 3.0^\circ</math></td> </tr> </table>		GENERAL TOLERANCES (UNLESS SPECIFIED)		ANGULAR TOL	$\pm 3.0^\circ$
DIMENSION UNITS	SCALE																								
mm	5:1																								
EC NO: 698973	2022/03/07																								
DRWN: GLLI	2022/03/11																								
CHK'D: XQZHANG	2022/03/11																								
APPR: XQZHANG	2022/03/11																								
GENERAL TOLERANCES (UNLESS SPECIFIED)																									
ANGULAR TOL	$\pm 3.0^\circ$																								
HEADER OF NANO-FIT, D/R, KINK, VERTICAL POWER CONNECTOR																									
DIVISIONAL SYMBOLS	<table border="1"> <tr> <td>4 PLACES</td> <td><math>\pm</math></td> </tr> <tr> <td>3 PLACES</td> <td><math>\pm 0.1</math></td> </tr> <tr> <td>2 PLACES</td> <td><math>\pm 0.2</math></td> </tr> <tr> <td>1 PLACE</td> <td><math>\pm 0.3</math></td> </tr> <tr> <td>0 PLACES</td> <td><math>\pm</math></td> </tr> </table>	4 PLACES	$\pm$	3 PLACES	$\pm 0.1$	2 PLACES	$\pm 0.2$	1 PLACE	$\pm 0.3$	0 PLACES	$\pm$	<table border="1"> <tr> <td>INITIAL REVISION:</td> <td></td> </tr> <tr> <td>DRWN: GLLI</td> <td>2019/09/24</td> </tr> <tr> <td>APPR: YXZHENG</td> <td>2020/03/16</td> </tr> </table>		INITIAL REVISION:		DRWN: GLLI	2019/09/24	APPR: YXZHENG	2020/03/16	<table border="1"> <tr> <td>PRODUCT CUSTOMER DRAWING</td> <td></td> </tr> </table>		PRODUCT CUSTOMER DRAWING			
4 PLACES	$\pm$																								
3 PLACES	$\pm 0.1$																								
2 PLACES	$\pm 0.2$																								
1 PLACE	$\pm 0.3$																								
0 PLACES	$\pm$																								
INITIAL REVISION:																									
DRWN: GLLI	2019/09/24																								
APPR: YXZHENG	2020/03/16																								
PRODUCT CUSTOMER DRAWING																									
<table border="1"> <tr> <td>DRAFT WHERE APPLICABLE MUST REMAIN WITHIN DIMENSIONS</td> <td>THIRD ANGLE PROJECTION</td> <td>DRAWING</td> <td>SERIES</td> <td>MATERIAL NUMBER</td> <td>CUSTOMER</td> <td>SHEET NUMBER</td> </tr> <tr> <td></td> <td></td> <td>A3-SIZE</td> <td>105310</td> <td></td> <td>GENERAL MARKET</td> <td>1 OF 5</td> </tr> </table>		DRAFT WHERE APPLICABLE MUST REMAIN WITHIN DIMENSIONS	THIRD ANGLE PROJECTION	DRAWING	SERIES	MATERIAL NUMBER	CUSTOMER	SHEET NUMBER			A3-SIZE	105310		GENERAL MARKET	1 OF 5	<table border="1"> <tr> <td>DOCUMENT NUMBER</td> <td>DOC TYPE</td> <td>DOC PART</td> <td>REVISION</td> </tr> <tr> <td>1053101000-SD</td> <td>PSD</td> <td>000</td> <td>B1</td> </tr> </table>		DOCUMENT NUMBER	DOC TYPE	DOC PART	REVISION	1053101000-SD	PSD	000	B1
DRAFT WHERE APPLICABLE MUST REMAIN WITHIN DIMENSIONS	THIRD ANGLE PROJECTION	DRAWING	SERIES	MATERIAL NUMBER	CUSTOMER	SHEET NUMBER																			
		A3-SIZE	105310		GENERAL MARKET	1 OF 5																			
DOCUMENT NUMBER	DOC TYPE	DOC PART	REVISION																						
1053101000-SD	PSD	000	B1																						

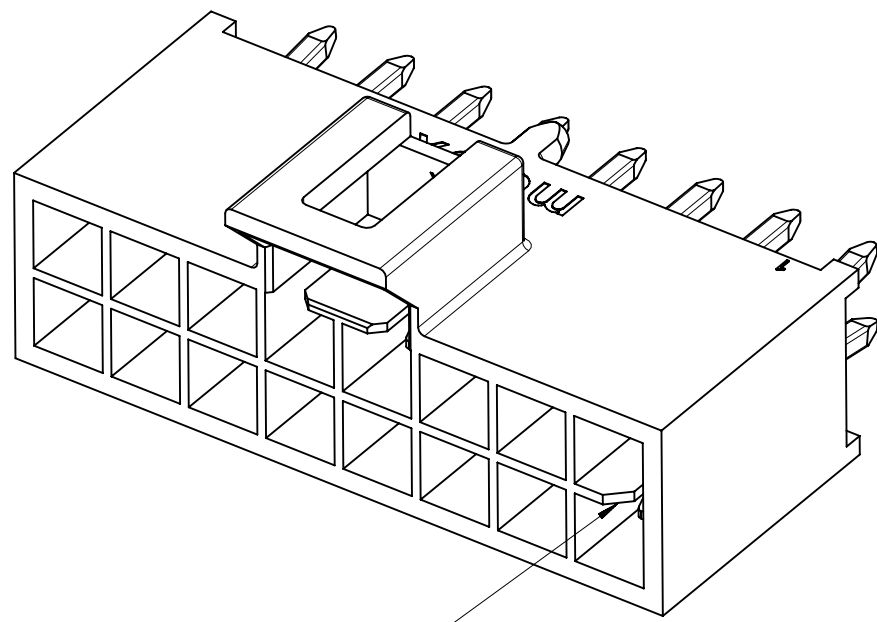

KEY A

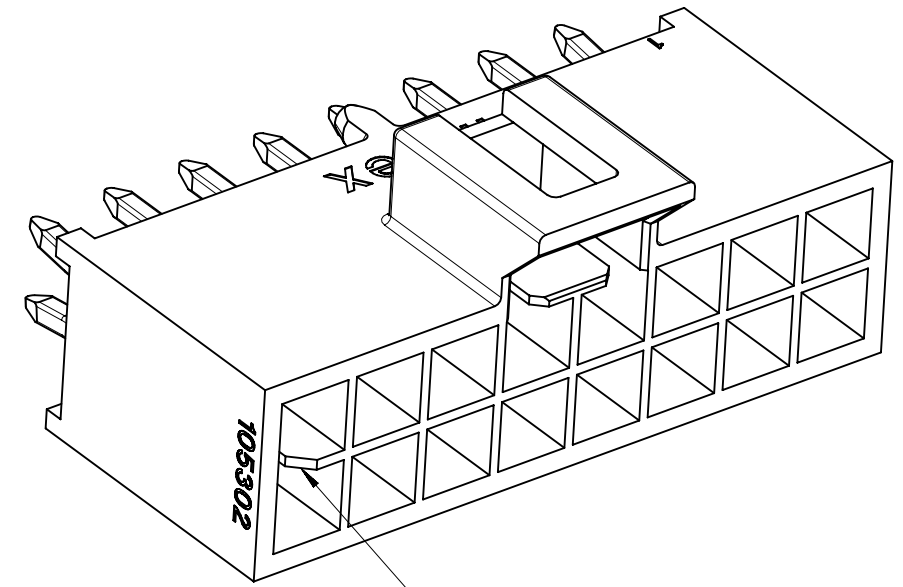

KEY B

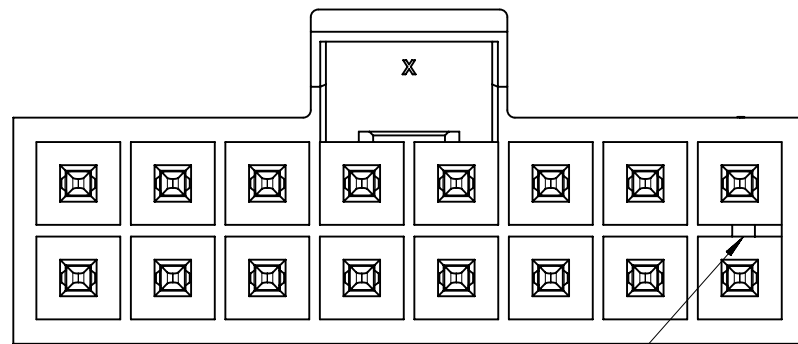

KEY A

BLACK

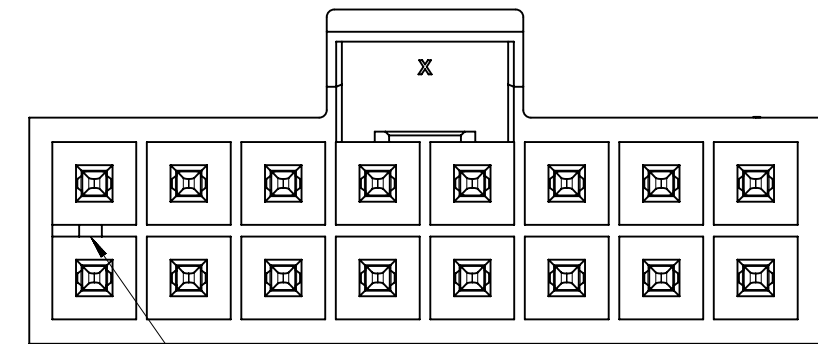

KEY B

NATURAL

COLOR OPTION

FUNCTIONAL SYMBOLS	THIS DRAWING CONTAINS INFORMATION THAT IS PROPRIETARY TO MOLEX ELECTRONIC TECHNOLOGIES, LLC AND SHOULD NOT BE USED WITHOUT WRITTEN PERMISSION		CURRENT REV DESC:		<b>molex</b>		
	$\nabla_A = 0$ $\nabla_E = 0$ $\nabla_F = 0$	DIMENSION UNITS: <b>mm</b> SCALE: <b>5:1</b>					
DIVISIONAL SYMBOLS	4 PLACES	$\pm$	EC NO: 698973	2022/03/07	PRODUCT CUSTOMER DRAWING		
	3 PLACES	$\pm 0.1$	DRWN: GLLI	2022/03/11			
	2 PLACES	$\pm 0.2$	CHK'D: XQZHANG	2022/03/11	DOC TYPE		
	1 PLACE	$\pm 0.3$	APPR: XQZHANG	2022/03/11	DOC PART		
	0 PLACES	$\pm$	INITIAL REVISION:		REVISION		
DRAFT WHERE APPLICABLE MUST REMAIN WITHIN DIMENSIONS		THIRD ANGLE PROJECTION	DRAWING	SERIES	MATERIAL NUMBER	CUSTOMER	SHEET NUMBER
			A3-SIZE	105310	1053101000-SD	GENERAL MARKET	2 OF 5

PART NUMBER	DIM 'A'	DIM 'B'	CKT SIZE	PLATING	MYLAR
105310-3504	5.94	2.50	4	TIN	YES
105310-3506	8.44	5.00	6		
105310-3508	10.94	7.50	8		
105310-3510	13.44	10.00	10		
105310-3512	15.94	12.50	12		
105310-3514	18.44	15.00	14		
105310-3516	20.94	17.50	16		
105310-3704	5.94	2.50	4	GOLD 0.38	YES
105310-3706	8.44	5.00	6		
105310-3708	10.94	7.50	8		
105310-3710	13.44	10.00	10		
105310-3712	15.94	12.50	12		
105310-3714	18.44	15.00	14		
105310-3716	20.94	17.50	16		
105310-3604	5.94	2.50	4	GOLD 0.76	YES
105310-3606	8.44	5.00	6		
105310-3608	10.94	7.50	8		
105310-3610	13.44	10.00	10		
105310-3612	15.94	12.50	12		
105310-3614	18.44	15.00	14		
105310-3616	20.94	17.50	16		
105310-3804	5.94	2.50	4	GOLD 0.76 + LUBE	YES
105310-3806	8.44	5.00	6		
105310-3808	10.94	7.50	8		
105310-3810	13.44	10.00	10		
105310-3812	15.94	12.50	12		
105310-3814	18.44	15.00	14		
105310-3816	20.94	17.50	16		

COLOR: BLACK

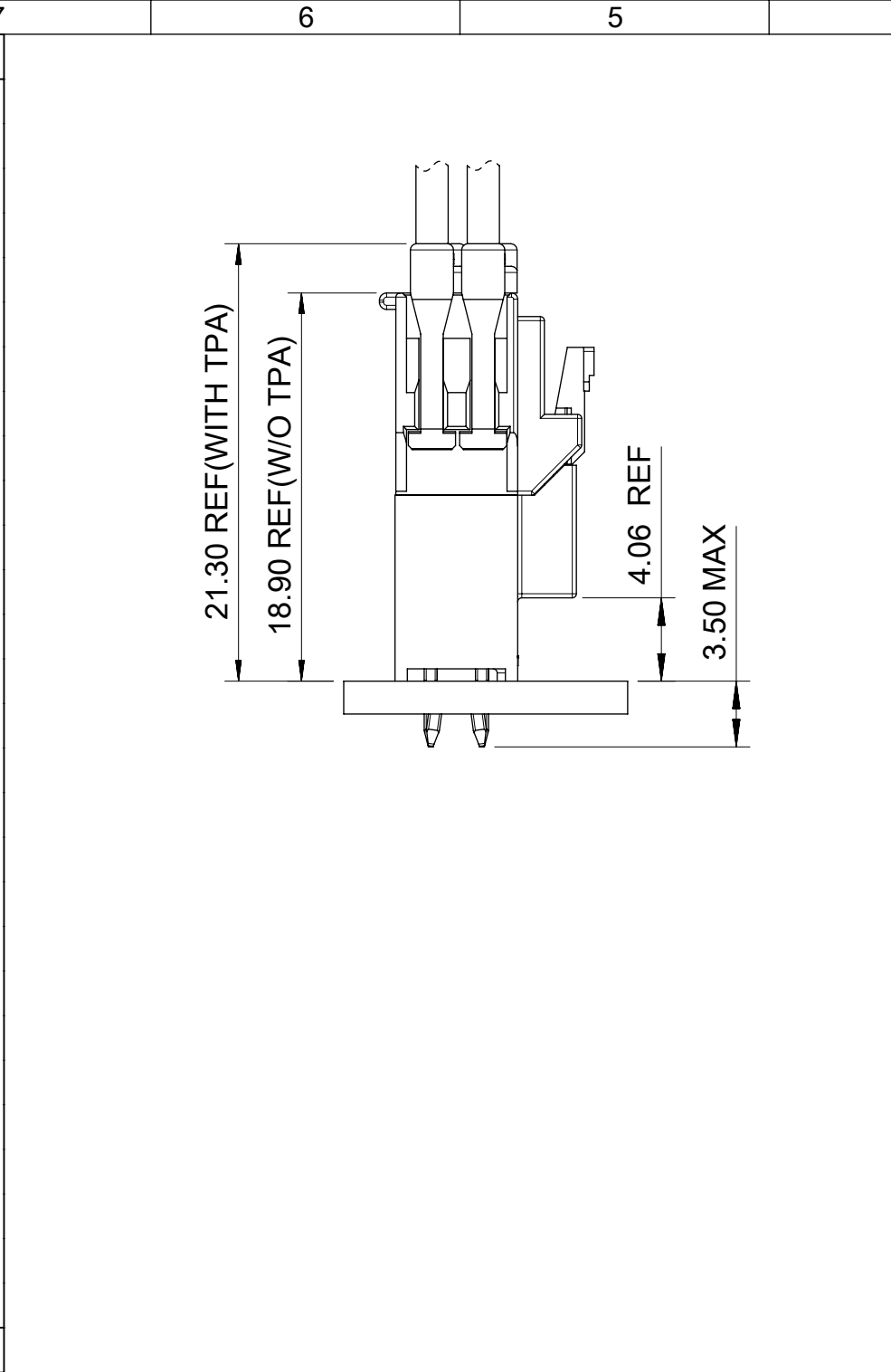

PART NUMBER	DIM 'A'	DIM 'B'	CKT SIZE	PLATING	MYLAR
105310-4504	5.94	2.50	4	TIN	YES
105310-4506	8.44	5.00	6		
105310-4508	10.94	7.50	8		
105310-4510	13.44	10.00	10		
105310-4512	15.94	12.50	12		
105310-4514	18.44	15.00	14		
105310-4516	20.94	17.50	16		
105310-4704	5.94	2.50	4	GOLD 0.38	YES
105310-4706	8.44	5.00	6		
105310-4708	10.94	7.50	8		
105310-4710	13.44	10.00	10		
105310-4712	15.94	12.50	12		
105310-4714	18.44	15.00	14		
105310-4716	20.94	17.50	16		
105310-4604	5.94	2.50	4	GOLD 0.76	YES
105310-4606	8.44	5.00	6		
105310-4608	10.94	7.50	8		
105310-4610	13.44	10.00	10		
105310-4612	15.94	12.50	12		
105310-4614	18.44	15.00	14		
105310-4616	20.94	17.50	16		
105310-4804	5.94	2.50	4	GOLD 0.76 + LUBE	YES
105310-4806	8.44	5.00	6		
105310-4808	10.94	7.50	8		
105310-4810	13.44	10.00	10		
105310-4812	15.94	12.50	12		
105310-4814	18.44	15.00	14		
105310-4816	20.94	17.50	16		

COLOR: NATURAL

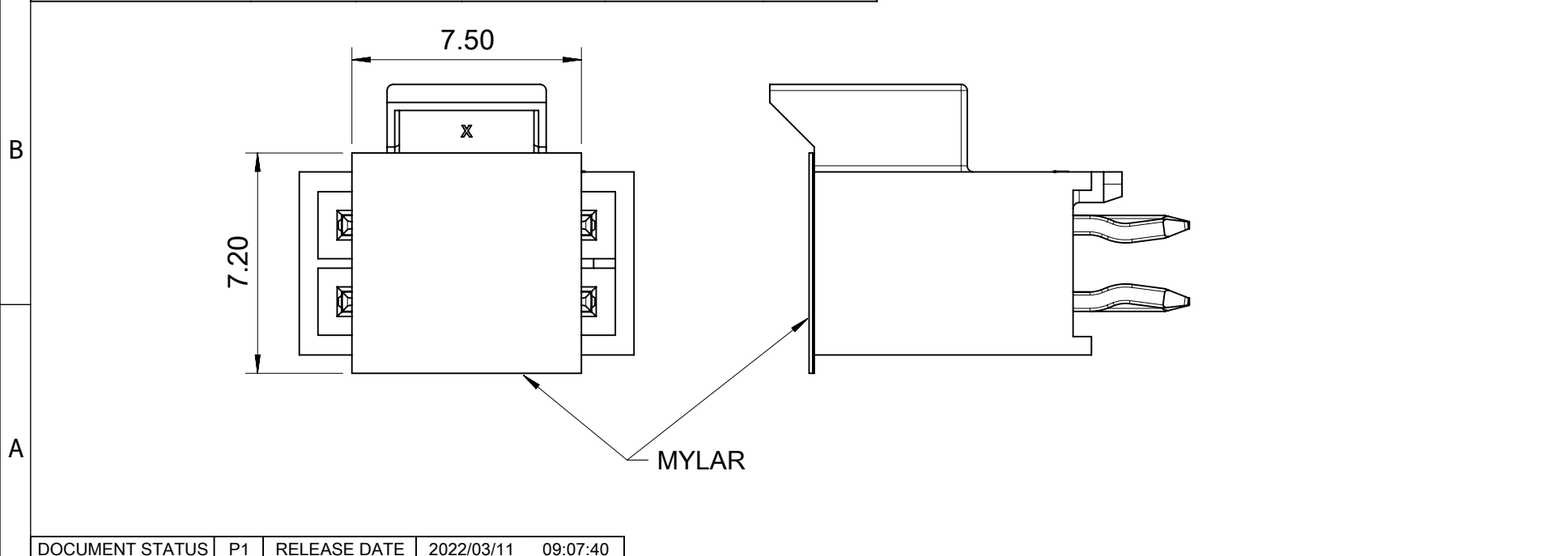

FUNCTIONAL SYMBOLS	THIS DRAWING CONTAINS INFORMATION THAT IS PROPRIETARY TO MOLEX ELECTRONIC TECHNOLOGIES, LLC AND SHOULD NOT BE USED WITHOUT WRITTEN PERMISSION		CURRENT REV DESC:		<b>molex</b>		
	mm	5:1					
DIVISIONAL SYMBOLS	GENERAL TOLERANCES (UNLESS SPECIFIED)		EC NO: 698973		HEADER OF NANO-FIT, D/R, KINK, VERTICAL POWER CONNECTOR		
	ANGULAR TOL ± 3.0°		DRWN: GLLI 2022/03/07				
DIVISIONAL SYMBOLS	4 PLACES	±	CHK'D: XQZHANG 2022/03/11		PRODUCT CUSTOMER DRAWING		
	3 PLACES	± 0.1	APPR: XQZHANG 2022/03/11				
	2 PLACES	± 0.2	INITIAL REVISION:		DOCUMENT NUMBER: 1053101000-SD		
	1 PLACE	± 0.3	DRWN: GLLI 2019/09/24				
0 PLACES	±	APPR: YXZHENG 2020/03/16		MATERIAL NUMBER: 105310			
DRAFT WHERE APPLICABLE MUST REMAIN WITHIN DIMENSIONS		THIRD ANGLE PROJECTION	DRAWING: A3-SIZE	SERIES: 105310	CUSTOMER: GENERAL MARKET		SHEET NUMBER: 3 OF 5

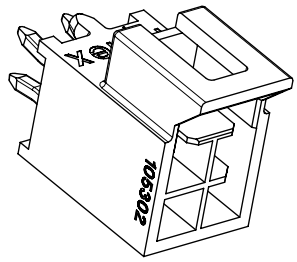
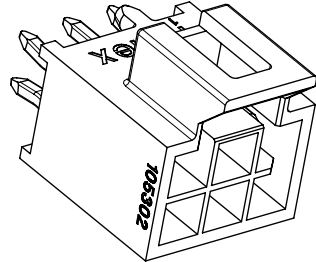
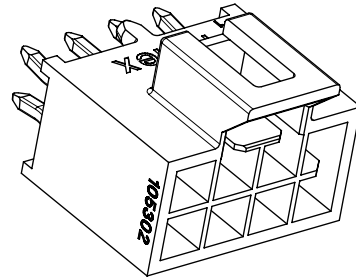
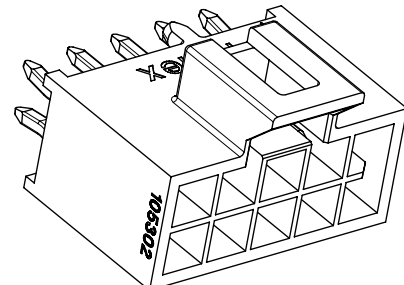
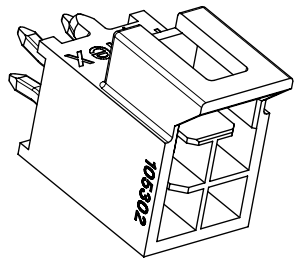
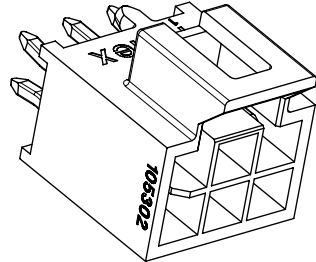
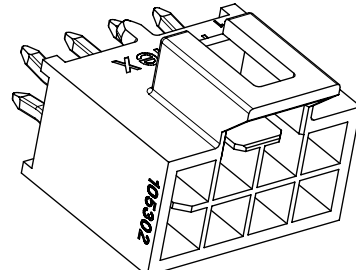
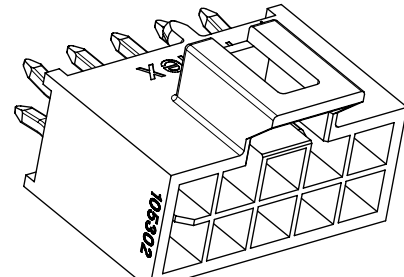
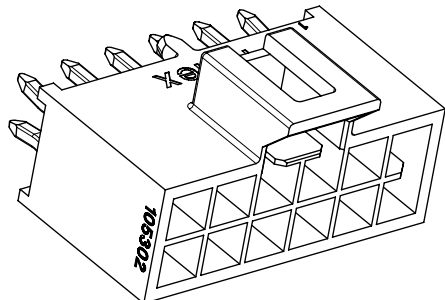
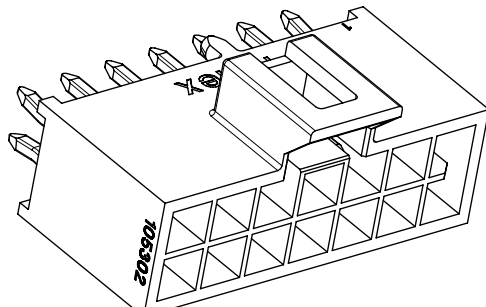
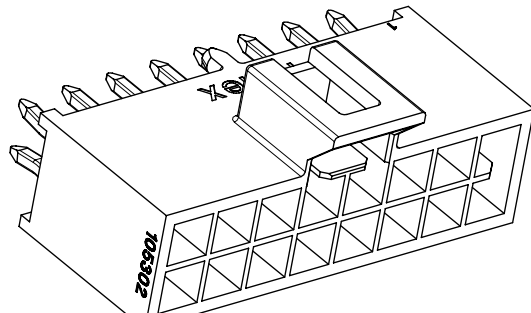
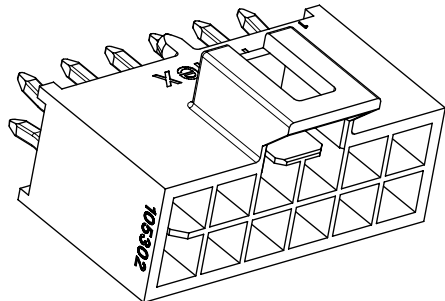
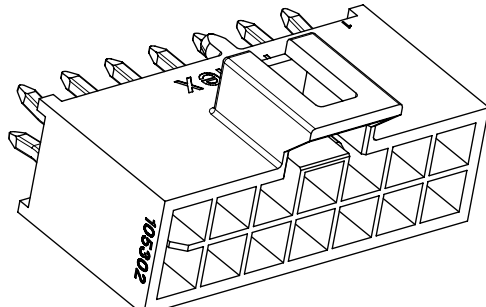
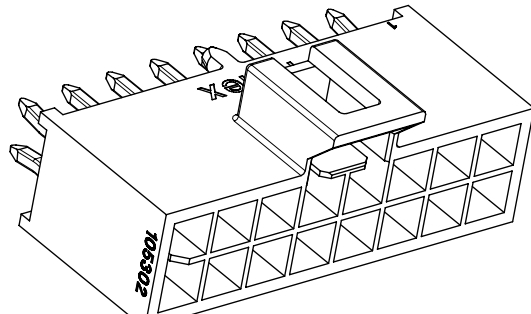
		4 CKT	6 CKT	8 CKT	10 CKT
F	BLACK				
E	NATURAL				
		12 CKT	14 CKT	16 CKT	
D	BLACK				
C	NATURAL				

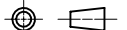
FUNCTIONAL SYMBOLS	THIS DRAWING CONTAINS INFORMATION THAT IS PROPRIETARY TO MOLEX ELECTRONIC TECHNOLOGIES, LLC AND SHOULD NOT BE USED WITHOUT WRITTEN PERMISSION		CURRENT REV DESC:		<b>molex</b>			
	SCALE	3:1						
FUNCTIONAL SYMBOLS	mm		GENERAL TOLERANCES (UNLESS SPECIFIED)		EC NO: 698973			
FUNCTIONAL SYMBOLS			ANGULAR TOL ± 3.0°		DRWN: GLLI 2022/03/07			
DIVISIONAL SYMBOLS	4 PLACES	±	4 PLACES ±		CHK'D: XQZHANG 2022/03/11			
DIVISIONAL SYMBOLS	3 PLACES	± 0.1	3 PLACES ± 0.1		APPR: XQZHANG 2022/03/11			
DIVISIONAL SYMBOLS	2 PLACES	± 0.2	2 PLACES ± 0.2		INITIAL REVISION:			
DIVISIONAL SYMBOLS	1 PLACE	± 0.3	1 PLACE ± 0.3		DRWN: GLLI 2019/09/24			
DIVISIONAL SYMBOLS	0 PLACES	±	0 PLACES ±		APPR: YXZHENG 2020/03/16			
DRAFT WHERE APPLICABLE MUST REMAIN WITHIN DIMENSIONS			THIRD ANGLE PROJECTION	DRAWING	SERIES	MATERIAL NUMBER	CUSTOMER	SHEET NUMBER
				A3-SIZE	105310	1053101000-SD	GENERAL MARKET	4 OF 5

NOTES FOR ALL PARTS

1> MATERIAL:  
HOUSING: LCP, UL 94V-0; TERMINAL: BRASS.

2> PLATING FINISHED:  
TERMINAL:  
CONTACT AREA: a. REFLOW MATTE TIN 1.5MICRONS MIN;  
b. GOLD 0.38 MICRONS MIN;  
c. GOLD 0.76 MICRONS MIN.  
SOLDER AREA: MATTE TIN 1.5 MICRONS MIN, UNDER PLATING NICKEL 1.25 MICRONS MIN.

3> PRODUCT SPECIFICATION: PS-105300-100.  
4> PACKAGE: TAPE REEL, 1053101000-PK.  
5> PRODUCT MATE WITH SERIES OF 105308(RECEPTACLE), 105300(CRIMP TERMINAL).  
6> PARTS CONFORM TO CLASS 'B'REQUIREMENTS OF COSMETIC SPECIFICATION PS-45499-002.  
7> DISCOLORATION IN THE BANDOLIER PIN CARRIER AREA OF THE PIN IS INHERENT TO THE PLATING PROCESS AND IS DUE TO THE MASKING DEFECT OF THE CARRIER, THIS DISCOLORATION IS IN A NON-FUNCTION AREA OF THE PIN AND WILL NOT AFFECT THE PERFORMANCE OF THE HEADER ASSEMBLY.

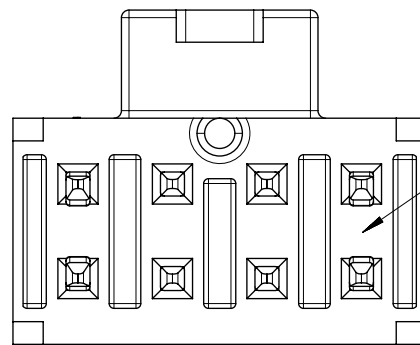

IF ANY NUMBER MARK APPEARS ON THIS SURFACE, PLEASE DISREGARD IT, IT IS NO ANY FUCTION AND NO ANY RELATION TO PIN NUMBER, IT IS JUST FOR MOLDING IDENDIFICATION.

FUNCTIONAL SYMBOLS										THIS DRAWING CONTAINS INFORMATION THAT IS PROPRIETARY TO MOLEX ELECTRONIC TECHNOLOGIES, LLC AND SHOULD NOT BE USED WITHOUT WRITTEN PERMISSION															
FUNCTIONAL SYMBOLS		DIMENSION UNITS		SCALE		CURRENT REV DESC:																			
▽/A = 0		mm		1:1		EC NO: 698973 DRWN: GLLI CHK'D: XQZHANG APPR: XQZHANG INITIAL REVISION: DRWN: GLLI APPR: YXZHENG																			
▽/E = 0		GENERAL TOLERANCES (UNLESS SPECIFIED)														2022/03/07									
▽/V = 0		ANGULAR TOL ± 3.0 °														2022/03/11									
DIVISIONAL SYMBOLS		4 PLACES ±														2022/03/11									
		3 PLACES ± 0.1				2019/09/24																			
		2 PLACES ± 0.2				2020/03/16																			
		1 PLACE ± 0.3				1053101000-SD																			
		0 PLACES ±				PSD 000 B1																			
DRAFT WHERE APPLICABLE MUST REMAIN WITHIN DIMENSIONS					THIRD ANGLE PROJECTION					DRAWING		SERIES		MATERIAL NUMBER		CUSTOMER		SHEET NUMBER							
										A3-SIZE		105310		GENERAL MARKET		5 OF 5									

**molex**

HEADER OF NANO-FIT, D/R, KINK, VERTICAL POWER CONNECTOR

PRODUCT CUSTOMER DRAWING