

【1. 適用範囲 SCOPE】

本仕様書は、0.5mm ピッチ FFC 対 基板 用 コネクタ について規定する。
This specification covers the 0.5mm PITCH FFC TO BOARD CONNECTOR series

【2. 製品名称及び型番 PRODUCT NAME AND PART NUMBER】

製品名称 Product Name	製品型番 Material Number
ハウジングアッセンブリ Housing Assembly (ST Type)	501786-**21
501786-**21 テーピング梱包 Embossed Tape Package for 501786-**21	501786-**80
プラグジャケット Plug Jacket	501783-**09
プラグジャケットカバー Plug Jacket Cover	501784-**09

* : 図面参照 Refer to the drawings.

【3. 定格 RATINGS】

項目 Item	規格 Standard	
最大許容電圧 Rated Voltage (MAX.)	50 V ^{*3}	[AC (実効値 rms) /DC]
最大許容電流 Rated Current (MAX.)	0.5 A ^{*3}	
使用温度範囲 ^{*1} Ambient Temperature Range	-40°C ~ +85°C ^{*2*3}	
保管条件 Storage condition	温度 Temperature	-10°C~+50°C
	湿度 Humidity	85%R.H.以下(但し結露なきこと) 85%R.H. MAX.(No condensation)
	期間 Term	出荷後6ヶ月以内(未開封の場合) For 6 months after shipping (unopened package)

*1 : 基板実装後の無通電状態は、使用温度範囲が適用されます。

Non-operating connectors after reflow must follow the operating temperature range condition.

*2 : 通電による温度上昇分を含む。

Including terminal temperature rise.

*3 : 使用FFCも本定格を満足すること。

FFC must be met ratings specified in this standard.

REV.	A	B																		
SHEET	1-15	1-20																		
REVISE ON PC ONLY						TITLE: 0.5mmPITCH FFC TO BOARD CONNECTOR 製品仕様書														
B	改訂 REVISED J2013-0749 '13/01/10 A.ISHII					THIS DOCUMENT CONTAINS INFORMATION THAT IS PROPRIETARY TO MOLEX INC. AND SHOULD NOT BE USED WITHOUT WRITTEN PERMISSION														
REV.	DESCRIPTION					WRITTEN BY: H.IIJIMA	CHECKED BY: KTAKAHASHI	APPROVED BY: KMORIKAWA	DATE: YR/MO/DAY 2005/03/17											
DESIGN CONTROL J						STATUS						FILE NAME PS501786002.DOC				SHEET 1 OF 20				
DOCUMENT NUMBER PS-501786-002																				

【4. 性能 PERFORMANCE】

4-1. 電気的性能 Electrical Performance

項目 Item	条件 Test Condition	規格 Requirement
4-1-1 接触抵抗 Contact Resistance	適合FFCハーネスを嵌合させ、開放電圧 20mV 以下、短絡電流 10mA 以下にて測定する。 (JIS C5402 5.4) Mate applicable FFC Harness, measure by dry circuit, 20mV MAX., 10mA MAX. (JIS C5402 5.4)	40 milliohm MAX.
4-1-2 絶縁抵抗 Insulation Resistance	適合FFCハーネスを嵌合させ、隣接するターミナル間及びターミナル、アース間に、DC 500V を印加し測定する。 (JIS C5402 5.2/MIL-STD-202 試験法 302) Mate applicable FFC Harness and apply 500V DC between adjacent terminal and ground. (JIS C5402 5.2/MIL-STD-202 Method 302)	50 Megohm MIN.
4-1-3 耐電圧 Dielectric Strength	適合FFCハーネスを嵌合させ、隣接するターミナル間及びターミナル、アース間に、AC 250V (実効値) を 1 分間 印加する。 (JIS C5402 5.1/MIL-STD-202 試験法 301) Mate applicable FFC Harness, apply 250V AC (rms) for 1 minute between adjacent terminal or ground. (JIS C5402 5.1/MIL-STD-202 Method 301)	異状なきこと No Breakdown

4-2. 機械的性能 Mechanical Performance

項目 Item	条件 Test Condition	規格 Requirement
4-2-1 挿入・抜去力 Insertion Force/ Withdrawal Force	ロックを解除した状態にて、毎分 25±3 mm の速さで挿入・抜去を行う。 Insert and withdraw connectors, at the speed rate of 25±3 mm per minute.	第6項参照 Refer to paragraph 6
4-2-2 強制抜去力 Compulsion Withdrawal Force	適合FFCハーネスを嵌合させ、ロックを解除せずに毎分 25±3 mm の速さで軸方向に引き抜く。 Mate applicable FFC Harness, apply axial pull out force at the speed rate of 25±3 mm per minute.	9.8 N { 1.0 kgf } MINIMUM
4-2-3 端子保持力 Terminal/Housing Retention Force	各端子を毎分 25±3mm の速さで引き抜く。 Apply axial pull out force at the speed rate of 25±3 mm/minute on the terminal assembled in the housing.	0.5N {0.05kgf} MIN.
4-2-4 金具保持力 Fitting nail / Housing Retention Force	各金具を毎分 25±3mm の速さで引き抜く。 Apply axial pull out force at the speed rate of 25±3 mm/minute on the fitting nail assembled in the housing.	1.0N {0.10kgf} MIN.

REVISE ON PC ONLY

B

SEE SHEET 1 OF 20

TITLE:

0.5mmPITCH FFC TO BOARD CONNECTOR
製品仕様書

THIS DOCUMENT CONTAINS INFORMATION THAT IS PROPRIETARY TO MOLEX INC. AND SHOULD NOT BE USED WITHOUT WRITTEN PERMISSION

REV.

DESCRIPTION

DOCUMENT NUMBER
PS-501786-002

FILE NAME
PS501786002.DOC

SHEET
2 OF 20

4-3. その他 Environmental Performance and Others

項目 Item		条件 Test Condition	規格 Requirement	
4-3-1	繰り返し挿抜 Repeated Mate / Un-mate	無通電状態にて、1分間に 10回以下の速さで挿入、抜去を 20回 繰り返す。 When mated up to 20 cycles repeatedly at the speed rate of less than 10 cycles per minute.	接触抵抗 Contact Resistance	60 milliohm MAX.
4-3-2	温度上昇 Temperature Rise	適合FFCハーネスを嵌合させ、最大許容電流を通電し、コネクタの温度上昇分を測定する。 (UL 498) Mate applicable FFC and measure the temperature rise of contact when the maximum AC rated current is passed. (UL 498)	温度上昇 Temperature Rise	30 °C MAX.
4-3-3	耐振動性 Vibration	DC 1mA 通電状態にて、嵌合軸を含む互いに垂直な 3方向 に掃引割合 10~55~10Hz/分、全振幅 1.5mm の振動を 各2時間 加える。 (MIL-STD-202試験法 201) Mate applicable FPC. Apply 0.1mA DC and subject to the following vibration conditions in each of 3 mutually perpendicular axes. Amplitude : 1.5 mm P-P Frequency : 10-55-10 Hz / minute. Duration : 2 hours in each (MIL-STD-202, Method 201)	外観 Appearance	異常なきこと No Damage
			接触抵抗 Contact Resistance	60 milliohm MAX.
			瞬断 Discontinuity	1 microsecond MAX
4-3-4	耐衝撃性 Shock	DC 1mA 通電状態にて、嵌合軸を含む互いに垂直な 6方向 に 490m/s ² {50G} の衝撃を 各3回 加える。 (JIS C041 / MIL-STD-202試験法 213) Mate applicable FPC and subject to the following shock conditions. 3 times of shocks shall be applied for each 6 directions along 3 mutually perpendicular axes, passing DC 1mA current during the test. (Total of 18 shocks) Test pulse : Half Sine Peak value : 490m/s ² {50G} (JIS C0041/MIL-STD-202 Method 213)	外観 Appearance	異常なきこと No Damage
			接触抵抗 Contact Resistance	60 milliohm MAX.
			瞬断 Discontinuity	1 microsecond MAX.

REVISE ON PC ONLY

B

SEE SHEET 1 OF 20

TITLE:

0.5mmPITCH FFC TO BOARD CONNECTOR
製品仕様書

THIS DOCUMENT CONTAINS INFORMATION THAT IS PROPRIETARY TO MOLEX INC. AND SHOULD NOT BE USED WITHOUT WRITTEN PERMISSION

REV.

DESCRIPTION

DOCUMENT NUMBER
PS-501786-002

FILE NAME
PS501786002.DOC

SHEET
3 OF 20

項目 Item		条件 Test Condition	規格 Requirement	
4-3-5	耐熱性 Heat Resistance	適合FFCハーネスを嵌合させ、85±2℃の 雰囲気中に96時間 放置後取り出し、1～2時間 室温に放置する。 (JIS C0021/MIL-STD-202 試験法 108) Mate applicable FPC and expose to 85+2/-2 degrees C for 96 hours. Upon completion of the exposure period, the test specimens shall be conditioned at ambient room conditions for 1 to 2 hours, after which the specified measurements shall be performed. (JIS C60068-2-2/MIL-STD-202 Method 108)	外観 Appearance	異常なきこと No Damage
			接触抵抗 Contact Resistance	60 milliohm MAX.
4-3-6	耐寒性 Cold Resistance	適合FFCハーネスを嵌合させ、-40±2℃の 雰囲気中に96時間 放置後取り出し、1～2時間 室温に放置する。 (JIS C60068-2-1) Mate applicable FPC and expose to -40+2/-2 degrees C for 96 hours. Upon completion of the exposure period, the test specimens shall be conditioned at ambient room conditions for 1 to 2 hours, after which the specified measurements shall be performed. (JIS C60068-2-1)	外観 Appearance	異常なきこと No Damage
			接触抵抗 Contact Resistance	60 milliohm MAX.
4-3-7	耐湿性 Humidity	適合FFCハーネスを嵌合させ、60±2℃ 相対 湿度 90～95% の雰囲気中に 96時間 放置後 取り出し、1～2時間 室温に放置する。 (JIS C60068-2-78/MIL-STD-202 試験法 103) Mate applicable FPC and expose to 60+2/-2 degrees C, relative humidity 90 to 95% for 96 hours. Upon completion of the exposure period, the test specimens shall be conditioned at ambient room conditions for 1 to 2 hours, after which the specified measurements shall be performed. (JIS C60068-2-78/MIL-STD-202 Method 103)	外観 Appearance	異常なきこと No Damage
			接触抵抗 Contact Resistance	60 milliohm MAX.
			耐電圧 Dielectric Strength	4-1-3項満足のこと Must meet 4-1-3
			絶縁抵抗 Insulation Resistance	20 Megohm MIN.

REVISE ON PC ONLY

B

SEE SHEET 1 OF 20

TITLE:

0.5mmPITCH FFC TO BOARD CONNECTOR
製品仕様書

THIS DOCUMENT CONTAINS INFORMATION THAT IS PROPRIETARY TO
MOLEX INC. AND SHOULD NOT BE USED WITHOUT WRITTEN PERMISSION

REV.

DESCRIPTION

DOCUMENT NUMBER
PS-501786-002

FILE NAME
PS501786002.DOC

SHEET
4 OF 20

項目 Item		条件 Test Condition	規格 Requirement	
4-3-8	温度サイクル Temperature Cycling	<p>適合FFCハーネスを嵌合させ、-55±3℃に30分、+85±2℃に30分、これを1サイクルとし、5サイクル繰り返す。 但し、温度移行時間は5分以内とする。 試験後1~2時間室温に放置する。 (JIS C0025)</p> <p>Mate applicable FPC and subject to the following conditions for 5 cycles. Upon completion of the exposure period, the test specimens shall be conditioned at ambient room conditions for 1 to 2 hours, after which the specified measurements shall be performed. (JIS C0025) 1 cycle a) -55+3/-3 degrees C 30 minutes b) +85+2/-2 degrees C 30 minutes (Transit time shall be within 3 minutes)</p>	外観 Appearance	異状なきこと No Damage
			接触抵抗 Contact Resistance	60 milliohm MAX.
4-3-9	亜硫酸ガス SO ₂ Gas	<p>適合FFCハーネスを嵌合させ、40±2℃にて50±5ppmの亜硫酸ガス中に24時間放置する。</p> <p>Mate applicable FPC and expose them to the following SO₂ gas atmosphere.</p> <p>Temperature 40+2/-2 degrees C Gas Density 50+5/-5 ppm Duration 24 hours</p>	接触抵抗 Contact Resistance	60 milliohm MAX.
4-3-10	半田付け性 Solder Ability	<p>端子先端より0.2mm、金具先端より0.2mmの位置まで、350±3℃の半田に5秒浸す。 Dip solder tails and fitting nail into the molten solder(held at 350+3/-3 degrees C) up to 0.2mm from the tip of the solder tails and fitting nails for 5 seconds.</p>	濡れ性 Solder Wetting	浸漬面積の75%以上 75% of immersed area must show no voids, pin holes.

REVISE ON PC ONLY

B

SEE SHEET 1 OF 20

TITLE:

0.5mmPITCH FFC TO BOARD CONNECTOR
製品仕様書

THIS DOCUMENT CONTAINS INFORMATION THAT IS PROPRIETARY TO MOLEX INC. AND SHOULD NOT BE USED WITHOUT WRITTEN PERMISSION

REV.

DESCRIPTION

DOCUMENT NUMBER
PS-501786-002

FILE NAME
PS501786002.DOC

SHEET
5 OF 20

項目 Item		条件 Test Condition	規格 Requirement	
4-3-11	半田耐熱性 Resistance to Soldering Heat	赤外線リフロー時 (Reflow by Infrared Reflow Machine) 第7項の推奨温度プロファイル条件にてリフローを行う。 Using the reflow profile condition below Paragraph 7.	外 観 Appearance	端子ガタ、 割れ等 異状無き事 No Damage
		手半田時 (Reflow by Manual Soldering iron) 端子先端、及び金具先端より0.3mmの位置まで、 $350 \pm 10^{\circ}\text{C}$ の半田ゴテにて3秒加熱する。 但し、異常な加圧のないこと。 Using a soldering iron ($350+10/-10$ degrees C for 3 seconds) heat up the area 0.3mm from the tip of the solder tails and fitting nails. However, do not apply excessive pressure to either the terminals or fitting nails.		

() : 参考規格 Reference Standard

{ } : 参考単位 Reference Unit

* 各項目の評価サンプルは、製品図面に記載されている推奨基板レイアウト、推奨メタルマスクにて実装しています。リフロー条件は4-3-13の推奨温度プロファイルにて実装しております。半田ペーストは、無鉛半田 (Sn-3Ag-0.5Cu) を使用しています。

The evaluation samples of each specification test are reflowed according to the recommended Print Circuit Board layout and the recommended metal mask thickness specified in the sales drawing. The reflow conditions followed are specified in the reflow profile in section 4-3-13. Lead free solder (Sn-3Ag-0.5Cu) was used as the soldering paste.

REVISE ON PC ONLY		TITLE: 0.5mmPITCH FFC TO BOARD CONNECTOR 製品仕様書	THIS DOCUMENT CONTAINS INFORMATION THAT IS PROPRIETARY TO MOLEX INC. AND SHOULD NOT BE USED WITHOUT WRITTEN PERMISSION
B	SEE SHEET 1 OF 20		
REV.	DESCRIPTION		
DOCUMENT NUMBER PS-501786-002		FILE NAME PS501786002.DOC	SHEET 6 OF 20

【5. 外観形状、寸法及び材質 PRODUCT SHAPE, DIMENSIONS AND MATERIALS】

図面参照 Refer to the drawing.

【6. 挿入・抜去力 INSERTION FORCE/WITHDRAWAL FORCE】

下記に示した表は、0.3mm厚のFFCを使用したときの挿入・抜去力の参考データを示しております。
Table shown below is a reference data of FFC insertion force and withdrawal force when using a thickness of 0.3mm FFC.

極数 No.	of CKT	単位 UNIT	挿入力 Insertion Force			抜去力 Withdrawal Force		
			平均値 AVG.	最大値 MAX.	最小値 MIN.	平均値 AVG.	最大値 MAX.	最小値 MIN.
30	初回 1st	N {kgf}	13.77 {1.41}	15.9 {1.62}	11.1 {1.13}	10.3 {1.05}	11.8 {1.20}	9.4 {0.96}
	10回目 10th	N {kgf}	11.24 {1.15}	12.7 {1.30}	10.0 {1.02}	7.84 {0.80}	8.7 {0.89}	6.8 {0.69}
	20回目 20th	N {kgf}	10.26 {1.05}	12.6 {1.29}	9.0 {0.92}	7.66 {0.78}	8.4 {0.86}	6.7 {0.68}
40	初回 1st	N {kgf}	18.88 {1.93}	22.3 {2.28}	14.5 {1.48}	12.48 {1.27}	13.0 {1.33}	12.2 {1.24}
	10回目 10th	N {kgf}	13.42 {1.37}	14.4 {1.47}	12.8 {1.31}	11.86 {1.21}	12.7 {1.30}	10.7 {1.09}
	20回目 20th	N {kgf}	13.22 {1.35}	14.2 {1.45}	12.4 {1.27}	11.48 {1.17}	13.0 {1.33}	10.1 {1.03}
50	初回 1st	N {kgf}	21.94 {2.24}	22.8 {2.33}	21.0 {2.14}	15.96 {1.63}	16.7 {1.70}	15.3 {1.56}
	10回目 10th	N {kgf}	17.32 {1.77}	18.3 {1.87}	15.7 {1.60}	13.76 {1.40}	15.6 {1.59}	12.4 {1.27}
	20回目 20th	N {kgf}	17.02 {1.74}	17.9 {1.83}	15.0 {1.53}	12.60 {1.29}	14.4 {1.47}	11.5 {1.17}

REVISE ON PC ONLY		TITLE: 0.5mmPITCH FFC TO BOARD CONNECTOR 製品仕様書
B	SEE SHEET 1 OF 20	
REV.	DESCRIPTION	THIS DOCUMENT CONTAINS INFORMATION THAT IS PROPRIETARY TO MOLEX INC. AND SHOULD NOT BE USED WITHOUT WRITTEN PERMISSION
DOCUMENT NUMBER PS-501786-002		FILE NAME PS501786002.DOC
		SHEET 7 OF 20

【7. 赤外線リフロー条件 INFRARED REFLOW CONDITION】

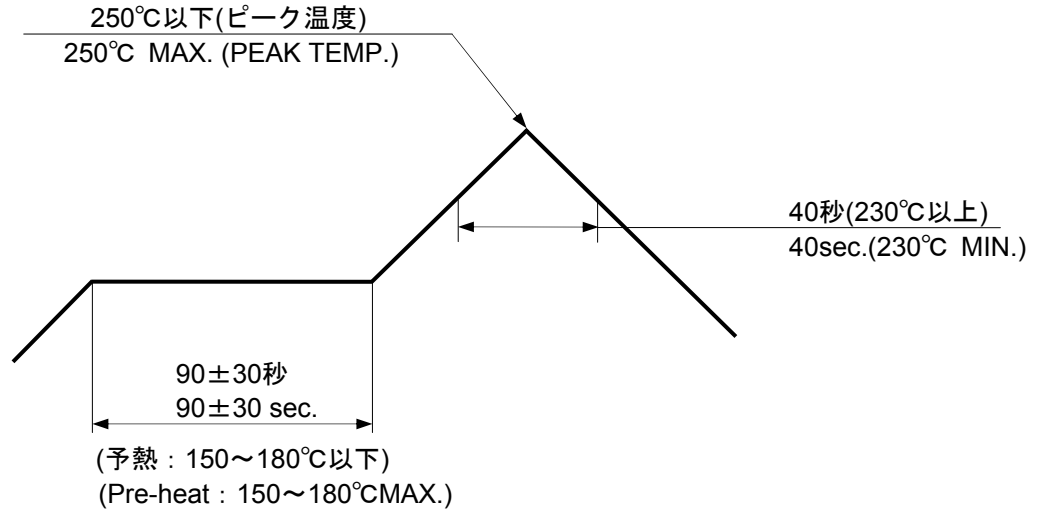

温度条件グラフ
TEMPERATURE CONDITION GRAPH

半田接合部の基板表面にて測定
(Temperature is measured at the soldering area on the surface of the print circuit board)

注記 : 本リフロー条件に関しては、温度プロファイル、半田ペースト、大気、N₂リフロー、基板などにより条件が異なりますので事前に実装評価(リフロー評価)を必ず実施願います。実装条件によっては、製品性能に影響を及ぼす場合があります。

NOTE: Please investigate the mounting condition (reflow soldering condition) on your own devices beforehand. The mounting conditions may change due to the soldering temperature, soldering paste, air reflow machine, Nitrogen reflow machine, and the type of printed circuit board. The different mounting conditions may have an influence on the product's performance.

REVISE ON PC ONLY		TITLE: 0.5mmPITCH FFC TO BOARD CONNECTOR 製品仕様書
B	SEE SHEET 1 OF 20	
REV.	DESCRIPTION	THIS DOCUMENT CONTAINS INFORMATION THAT IS PROPRIETARY TO MOLEX INC. AND SHOULD NOT BE USED WITHOUT WRITTEN PERMISSION
DOCUMENT NUMBER PS-501786-002		FILE NAME PS501786002.DOC
		SHEET 8 OF 20

【8. 取り扱い説明書 INSTRUCTION FOR THE HANDLING OF THE CONNECTOR】

8-1. 各部の名称 DESCRIPTION OF EACH PART

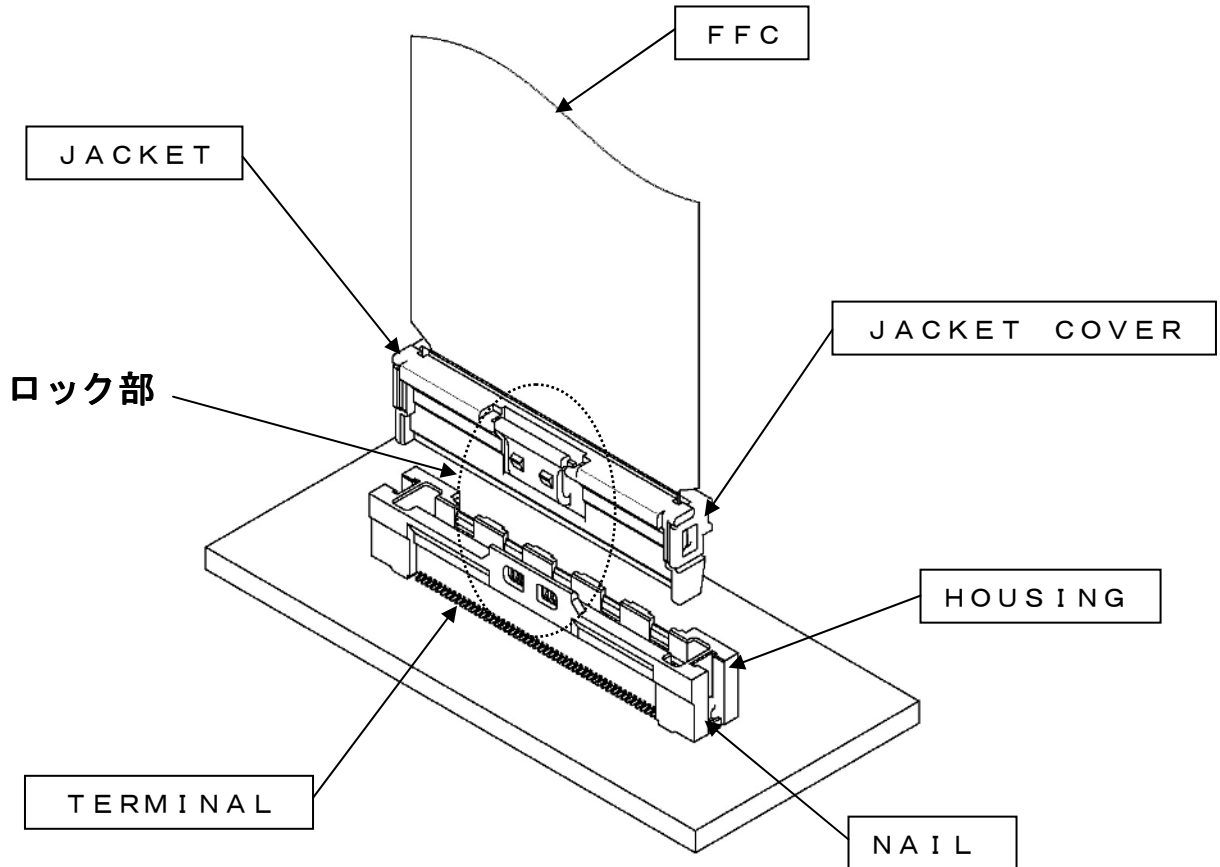

8-2. 基板への実装に関して MOUNTING ON THE PC BOARD

基板への実装は実装機にて実施願います。もし、手半田する場合は、TERMINAL及びNAIL等に触れない様に願います。（半田付け不良等の原因となる可能性が有ります。）

The mounting of the PC board is handled by the mounter. If to manually solder, please be cautious to not touch the Terminal and Fitting Nail.(It will create the possibility to cause solderbility failure.)

REVISE ON PC ONLY		TITLE:	
B	SEE SHEET 1 OF 20	0.5mmPITCH FFC TO BOARD CONNECTOR 製品仕様書	
REV.	DESCRIPTION	THIS DOCUMENT CONTAINS INFORMATION THAT IS PROPRIETARY TO MOLEX INC. AND SHOULD NOT BE USED WITHOUT WRITTEN PERMISSION	
DOCUMENT NUMBER PS-501786-002		FILE NAME PS501786002.DOC	SHEET 9 OF 20

8-3. コネクタ嵌合に関して MATING THE CONNECTOR

コネクタを嵌合する際は、JACKETとJACKET COVERの全体もしくは中央を掴んで挿入を実施ください。

When mating the connector, hold the JACKET AND JACKET COVER together at either a whole or the center portion of them to insert.

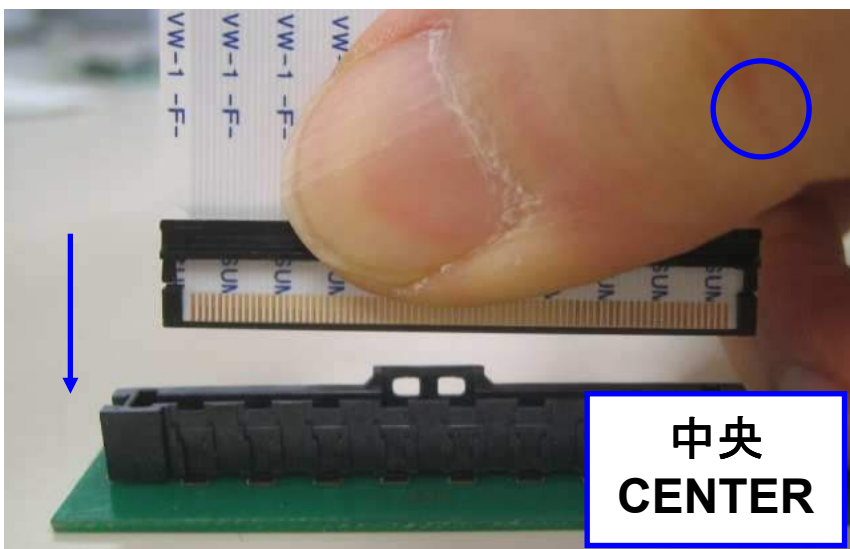

B	REVISE ON PC ONLY	TITLE: 0.5mmPITCH FFC TO BOARD CONNECTOR 製品仕様書
	SEE SHEET 1 OF 20	
REV.	DESCRIPTION	THIS DOCUMENT CONTAINS INFORMATION THAT IS PROPRIETARY TO MOLEX INC. AND SHOULD NOT BE USED WITHOUT WRITTEN PERMISSION
DOCUMENT NUMBER PS-501786-002		FILE NAME PS501786002.DOC
		SHEET 10 OF 20

以下のような嵌合は回復不可能な機能不全や製品破壊につながりますので実施しないで下さい。
The following method of mating will cause either irreversable functionality failure or product breaking, so please do not mate this way.

- ・ F F Cのみを掴まないでください。
Please do not hold the FFC part only



- ・ J A C K E TとJ A C K E T C O V E Rの 端部のみを掴まないでください。
Please do not hold the JACKET AND edge of the JACKET COVER only

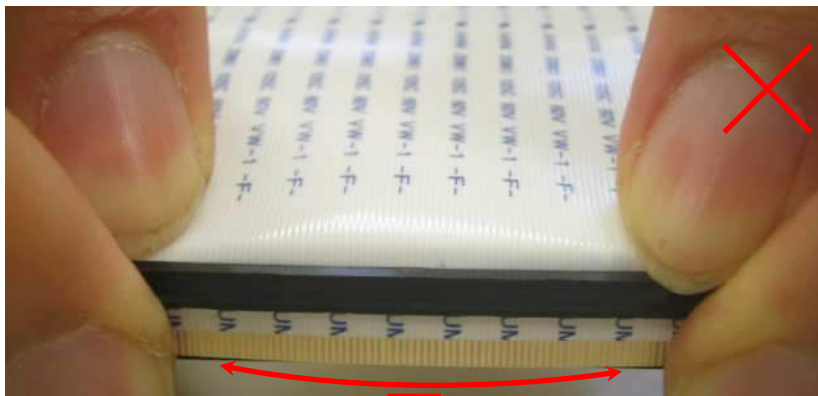

REVISE ON PC ONLY		TITLE:	
B	SEE SHEET 1 OF 20	0.5mmPITCH FFC TO BOARD CONNECTOR 製品仕様書	
REV.	DESCRIPTION	THIS DOCUMENT CONTAINS INFORMATION THAT IS PROPRIETARY TO MOLEX INC. AND SHOULD NOT BE USED WITHOUT WRITTEN PERMISSION	
DOCUMENT NUMBER PS-501786-002		FILE NAME PS501786002.DOC	SHEET 11 OF 20

- ・ F F C を折り曲げるように掴まないでください。
Please do not hold the FFC like bending it.

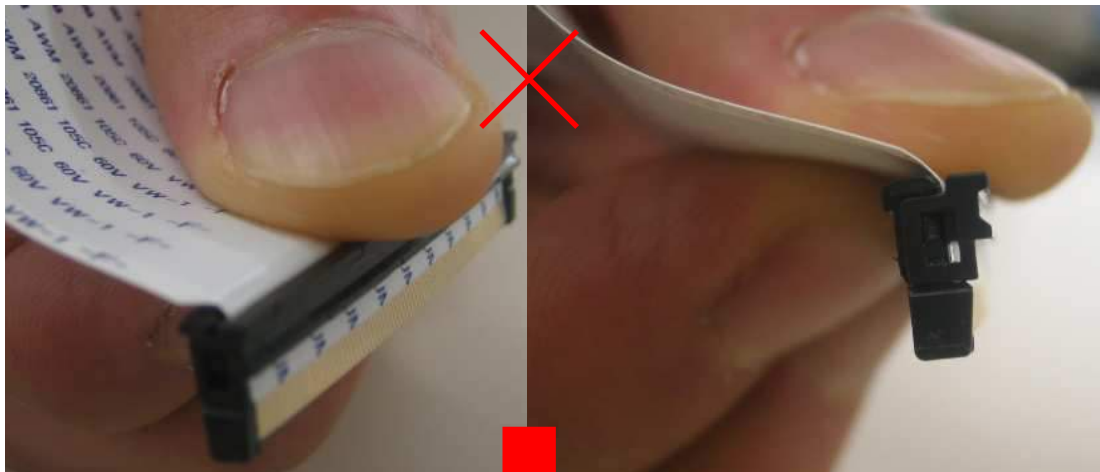

B	REVISE ON PC ONLY	TITLE: 0.5mmPITCH FFC TO BOARD CONNECTOR 製品仕様書	
	SEE SHEET 1 OF 20		
	REV.	DESCRIPTION	THIS DOCUMENT CONTAINS INFORMATION THAT IS PROPRIETARY TO MOLEX INC. AND SHOULD NOT BE USED WITHOUT WRITTEN PERMISSION
DOCUMENT NUMBER PS-501786-002		FILE NAME PS501786002.DOC	SHEET 12 OF 20

- ※ FFCが極端に浮くと、嵌合時にHOUSINGと干渉し座屈する可能性があります。
- ※ If FFC warps too much, it will touch with the Header housing when mated,

and may possibly cause buckling.

**FFCの極端な浮き
TO WARPED FFC**

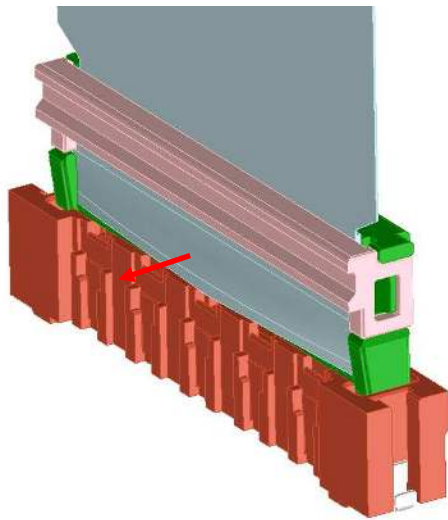

**干渉
TOUCH**

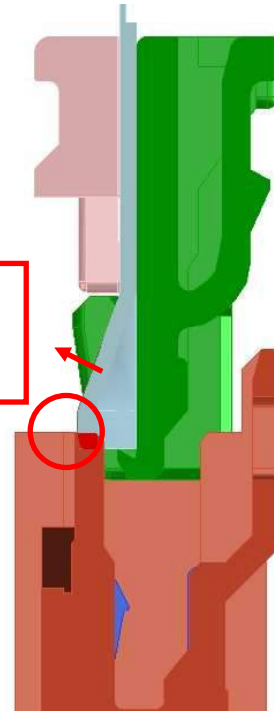

- ・ JACKETとJACKET COVERの片端のみを掴まないでください。
斜め嵌合となり、不良につながります。
Please do not hold one side of the JACKET and the JACKET COVER only as shown below.
It will be mated in the slant direction and will cause failure

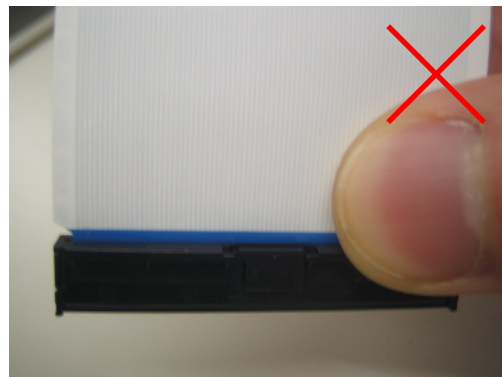

REVISE ON PC ONLY	
B	SEE SHEET 1 OF 20
REV.	DESCRIPTION

TITLE: 0.5mmPITCH FFC TO BOARD CONNECTOR 製品仕様書
THIS DOCUMENT CONTAINS INFORMATION THAT IS PROPRIETARY TO MOLEX INC. AND SHOULD NOT BE USED WITHOUT WRITTEN PERMISSION

DOCUMENT NUMBER PS-501786-002	FILE NAME PS501786002.DOC	SHEET 13 OF 20
---	------------------------------	-------------------

- ・斜め嵌合は不良につながりますので実施しないでください。
Mating inconsistently will cause failure, so please do not do this.

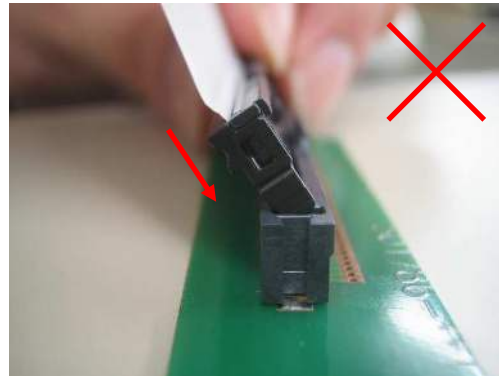
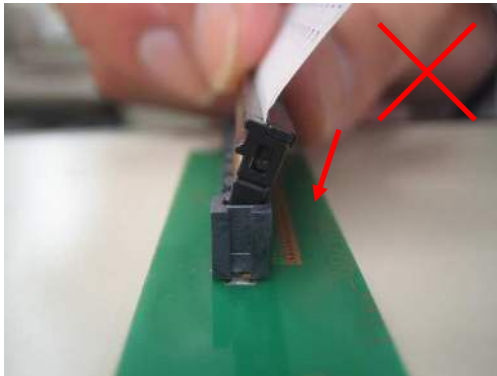
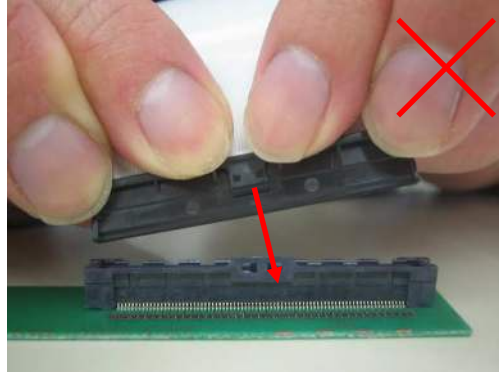
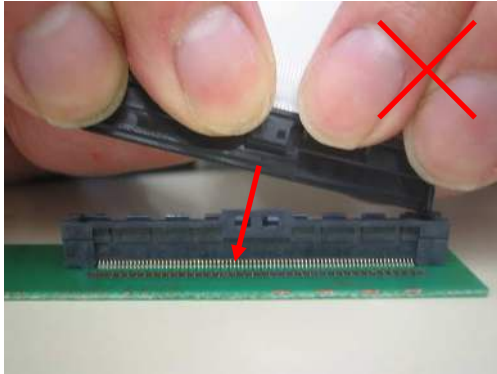

- ・嵌合状態 及び 嵌合時の FFC 引き回し作業においてロック部に無理な負荷が掛かるような使用は避けてください。コネクタ破壊やはんだクラックを引き起こします。
Please be cautious not to put excess load at the lock part after mating and when FFC is pulled and extracted. It may cause damage to the connector and may crack the soldering.

REVISE ON PC ONLY		TITLE: 0.5mmPITCH FFC TO BOARD CONNECTOR 製品仕様書
B	SEE SHEET 1 OF 20	
REV.	DESCRIPTION	THIS DOCUMENT CONTAINS INFORMATION THAT IS PROPRIETARY TO MOLEX INC. AND SHOULD NOT BE USED WITHOUT WRITTEN PERMISSION
DOCUMENT NUMBER PS-501786-002		FILE NAME PS501786002.DOC
		SHEET 14 OF 20

コネクタの嵌合を取り外す際は、必ずロック解除して実施ください。万が一、ロックを解除していない状態でFFCを抜いた時は、コンタクト部に付着物が無いか確認の上、再装着願います。

Please be sure to release the lock when unmating the connector. If the FFC is withdrawn without the lock has not been released, please check to make sure that there is no debris on the contact area before inserting the FPC again.

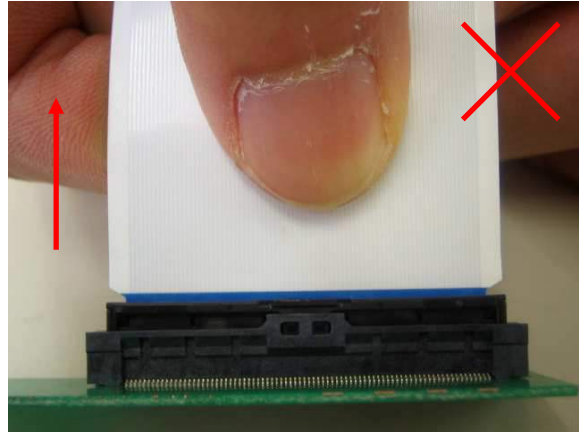
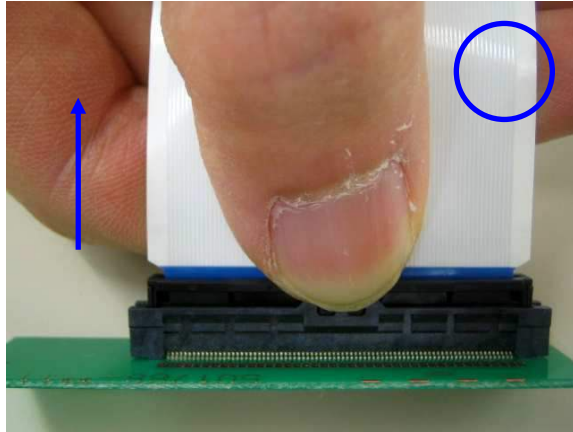

B	REVISE ON PC ONLY	TITLE: 0.5mmPITCH FFC TO BOARD CONNECTOR 製品仕様書	
	SEE SHEET 1 OF 20		
	REV.	DESCRIPTION	THIS DOCUMENT CONTAINS INFORMATION THAT IS PROPRIETARY TO MOLEX INC. AND SHOULD NOT BE USED WITHOUT WRITTEN PERMISSION
DOCUMENT NUMBER PS-501786-002		FILE NAME PS501786002.DOC	SHEET 15 OF 20

【9. 注意事項 NOTES】

9-1外観について

9-1-1

本製品の樹脂部に黒点、ウエルド部の線、多少の傷が確認される事がありますが、製品性能には影響ございません。

Although this product may have a small black mark, a weld line or a scratch on the housing, these will not have any influence on the product's performance.

9-1-2

成形品の色相に多少の違いを生じる場合がありますが、製品性能には影響ありません。

There may be slight differences in the housing coloring, but there will be no influence on the product's performance.

9-1-3

紫外線により変色する場合がありますが、製品性能に影響ありません。

Although the ultraviolet light may potentially change the color, this change has no on the product's performance.

9-2実装について

9-2-1

実装性能（平坦度）は、実装基板の反りの影響を含まないものと致します。

基板の反りはコネクタ両端部を基準とし、コネクタ中央部にて Max0.02mmとして下さい。

The mounting specification for coplanarity does not include the influence of warpage of the printed circuit board.

The warpage of the printed circuit board should be a maximum of 0.02mm if measuring from one connector edge to the other.

9-2-2

本製品の一般性能確認はリジット基板にて実施おります。

フレキシブル基板等の特殊な基板へ実装する場合は、事前に実装確認等を行った上でご使用願います。

The product performance was tested using rigid printed circuit board.

In case the product needs to be reflowed onto flexible circuit board, please conduct a reflow test on the flexible circuit board in advance.

9-2-3

フレキシブル基板に実装する場合は、基板の変形を防止するため、補強板をご使用願います。

Please add a stiffener on the flexible printed circuit (FFC) when you mount the connector onto FFC in order to prevent deformation of the FFC.

9-2-4

リフロー条件によっては、樹脂部の変色や端子めっき部にヨリが発生する場合がありますが、製品性能に影響はございません。

Depending on the reflow conditions, there may be the possibility of a color change in the housing.

However, this color change does not have any effect on the product's performance.

REVISE ON PC ONLY		TITLE: 0.5mmPITCH FFC TO BOARD CONNECTOR 製品仕様書	THIS DOCUMENT CONTAINS INFORMATION THAT IS PROPRIETARY TO MOLEX INC. AND SHOULD NOT BE USED WITHOUT WRITTEN PERMISSION
B	SEE SHEET 1 OF 20		
REV.	DESCRIPTION		
DOCUMENT NUMBER PS-501786-002		FILE NAME PS501786002.DOC	SHEET 16 OF 20

9-2-5

リフロー後、半田付け部に変色が見られることがありますが、製品性能に影響はありません。
Although there might be some discoloration seen on the soldering tail after reflow, this will not influence the product's performance.

9-2-6

半田実装部の未半田は、ターミナル脱落、ピン間ショート、ターミナル座屈、またコネクタの基板からの外れが懸念されます。従って全てのターミナルテール部及び、ネイル部に半田付けを行って下さい。
If you leave any soldering area on this product open, there may be the possibility of a missing terminal short circuiting between pins, terminal buckling or the potential for the connector to come off of the printed circuit board. Therefore, please solder all of the terminals and fitting nails on the printed circuit board.

9-2-7

実装機によってコネクタに負荷が加わると変形、破損する場合がありますので事前にご確認下さい。
If there is accidental contact with the connector while it is going through the reflow machine, there may be deformation or damage caused to the connector. Please check to prevent this.

9-3製品の仕様について

9-3-1

コネクタの性能を損なう恐れがある為、コネクタの洗浄は、行わないで下さい。
Please do not conduct any "washing process" on the connector because it may damage the product's function.

9-3-2

適合するFFCの導体部は、錫系めっき（ニッケル下地）品を使用願います。
Please make sure to use the appropriate FFC which has Tin plating (Nickel under plating) on the contact area.

9-3-3

量産前にご使用になるFFCとの相性確認を行った上で、ご使用をお願い致します。
Please check the compatibility between the connector and the FFC prior to moving to mass production.

B	REVISE ON PC ONLY		TITLE: 0.5mmPITCH FFC TO BOARD CONNECTOR 製品仕様書	
	SEE SHEET 1 OF 20			THIS DOCUMENT CONTAINS INFORMATION THAT IS PROPRIETARY TO MOLEX INC. AND SHOULD NOT BE USED WITHOUT WRITTEN PERMISSION
	REV.	DESCRIPTION		
DOCUMENT NUMBER PS-501786-002			FILE NAME PS501786002.DOC	SHEET 17 OF 20
EN-037(2012-05)				

9-3-4

コネクタにFFCを装着した状態で、FFCに過度の負荷が加わらないようにご注意ください、御社基板のスペース上、コネクタに負担の掛かる位置への取り付けはしないで下さい。
コネクタのロックが解除されたり、FFCの抜け、断線、破損や接触不良の原因になります。
特に、連続的に加わる場合はFFCを固定するようにして下さい。
また、基板に対して垂直上下方向の引張荷重、コンタクトピッチ方向のこじり荷重を与えない様にご注意願います。
Please pay special attention not to have any pulling force/tension on the FFC when it is inserted into the connector. This can cause; the actuator to be unlocked, the actuator to come off, cut the traces on the FFC, and/or damage the FFC.
Please be especially careful to avoid placing the FFC in a location where it will have a constant force applied on the FFC, If necessary, please fix the FFC directly on the chassis.
Also, please avoid pulling the FFC vertically or twisting the FFC back and force horizontally while it is inserted in the connector.

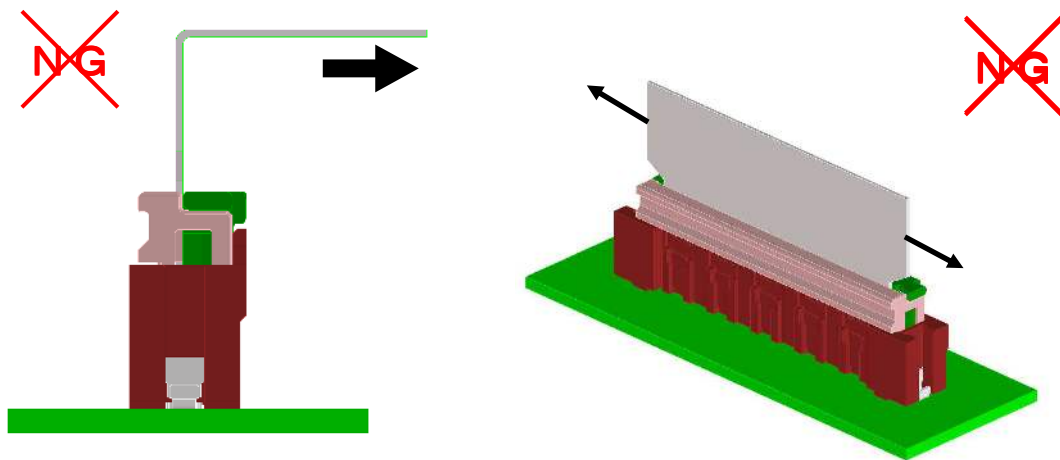

9-3-5

本製品をご使用時に取り付けられた電線・プリント基板の共振や、機器の回転構造や可動部分の動作によりコネクタ嵌合部（接点部）が常に動いてしまう状態での御使用は避けて下さい。
接触部の摺動磨耗等による 接触不良の原因となります。
従って、機器内で電線・プリント基板を固定し、共振を抑える等の処置をお願い致します。
Please do not use the connector in a condition where the wire, the printed circuit board, or the contact area is experiencing a sympathetic vibration of wires and printed circuit board, and constant movement of devices. This may cause a defect in the contact due to the contact area being worn down.
Therefore, please fix wires and printed circuit board on the chassis, and reduces sympathetic vibration.

9-3-6

活電状態の電気回路で、挿入、抜去ができることを前提に作られていません。スパーク等による危険の発生、性能不良につながりますので、活電状態での挿入、抜去はしないで下さい。
This product is not designed for the mating and unmating of the connectors to be performed under the condition of an active electrical circuit. It may cause a spark and product defect if the connectors are mated and unmated in this way.

REVISE ON PC ONLY		TITLE: 0.5mmPITCH FFC TO BOARD CONNECTOR 製品仕様書
B	SEE SHEET 1 OF 20	
REV.	DESCRIPTION	THIS DOCUMENT CONTAINS INFORMATION THAT IS PROPRIETARY TO MOLEX INC. AND SHOULD NOT BE USED WITHOUT WRITTEN PERMISSION
DOCUMENT NUMBER PS-501786-002		FILE NAME PS501786002.DOC
		SHEET 18 OF 20

9-3-7

本製品の端子は錫メッキを使用しております。ご使用になるFFCとの相性確認としてウイスキー評価の実施を推奨いたします。

The terminals for this product are tin plated. We recommend that a Tin whiskering test is performed between your FFC and the connector beforehand to ensure that they are compatible.

9-3-8

コネクタに外力が加わらないようにクリアランスをあげた筐体構造にしてください。

Please keep enough clearance between connector and chassis of your application in order not to apply pressure on the connector.

9-3-9

基板実装後に基板を直接積み重ねない様に注意してください。

Please do not stack the printed circuit board directly after mounted the connector on it.

9-4リペアについて

9-4-1

実装後において半田ごてによる手修正を行う際は、必ず仕様書掲載の条件以内で行ってください。

条件を超えて実施した場合、端子の抜け、接点ギャップの変化、モールドの変形、溶融等、破損の原因になります。When conducting manual repairs using a soldering iron, please follow the soldering conditions shown in the product specification.

If the conditions in the product spec are not followed, it may cause the terminals to fall off, a change in the contact gap, a deformation of the housing, melting of the housing, and damage the connector.

9-4-2

半田ゴテによる手修正を行なう際、過度の半田やフラックスを使用しないで下さい。

半田上がりやフラックス上がりにより接触、機能不良に至る場合があります。

When conducting manual repairs using a soldering iron, please do not use more solder and flux than needed.

This may cause solder wicking and flux wicking issues, and it will eventually cause a contact defect and functional issues.

【10. 環境指令への適合 COMPLIANCE WITH ENVIRONMENTAL DIRECTIVE】

ELV及びRoHS適合品

ELV and RoHS Compliant

B	REVISE ON PC ONLY		TITLE: 0.5mmPITCH FFC TO BOARD CONNECTOR 製品仕様書	
	SEE SHEET 1 OF 20			
	REV.	DESCRIPTION	THIS DOCUMENT CONTAINS INFORMATION THAT IS PROPRIETARY TO MOLEX INC. AND SHOULD NOT BE USED WITHOUT WRITTEN PERMISSION	
DOCUMENT NUMBER PS-501786-002			FILE NAME PS501786002.DOC	SHEET 19 OF 20

