

## Aluminum Electrolytic Capacitors SMD (Chip) Long Life Vertical

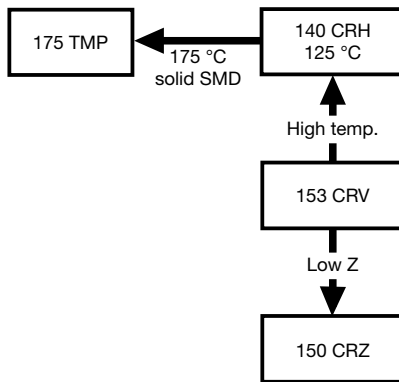

Fig. 1

QUICK REFERENCE DATA	
DESCRIPTION	VALUE
Nominal case sizes (L x W x H in mm)	4.0 x 4.0 x 5.3 to 10 x 10 x 14
Rated capacitance range, C <sub>R</sub>	0.47 μF to 1000 μF
Tolerance on C <sub>R</sub>	± 20 %
Rated voltage range, U <sub>R</sub>	6.3 V to 100 V
Category temperature range	-55 °C to +105 °C
Endurance test at 105 °C:	
Case sizes 4.0 x 4.0 x 5.3 to 6.3 x 6.3 x 5.3	1000 h
Case sizes 8.0 x 8.0 x 6.5 to 10 x 10 x 14	2000 h
Useful life at 105 °C:	
Case sizes 4.0 x 4.0 x 5.3 to 6.3 x 6.3 x 5.3	2000 h
Case sizes 8.0 x 8.0 x 6.5 to 10 x 10 x 14	3000 h
Useful life at 40 °C; 1.3 x I <sub>R</sub> applied:	
Case sizes 4.0 x 4.0 x 5.3 to 6.3 x 6.3 x 5.3	200 000 h
Case sizes 8.0 x 8.0 x 6.5 to 10 x 10 x 14	300 000 h
Shelf life at 0 V, 105 °C	1000 h
Based on sectional specification	IEC 60384-18 / CECC 32300
Climatic category IEC 60068	55 / 105 / 56

### FEATURES

- Polarized aluminum electrolytic capacitors, non-solid electrolyte, self healing
- SMD-version with base plate, vertical construction requiring minimum board space, lead (Pb)-free reflow solderable
- High CV per unit volume
- Long useful life: 2000 h to 3000 h at 105 °C
- Charge and discharge proof, no peak current limitation
- Supplied in blister tape on reel
- ATTENTION: for maximum safe soldering conditions refer to Fig. 4
- Material categorization: for definitions of compliance please see [www.vishay.com/doc?99912](http://www.vishay.com/doc?99912)



### APPLICATIONS

- SMD technology, in compliance with RoHS
- Coupling, decoupling, smoothing, filtering, buffering, timing
- Telecommunications, general industrial, EDP, automotive, portable and lightweight equipment

### MARKING

- Rated capacitance (in μF)
- Rated voltage (in V)
- Date code
- Black mark or “-” sign indicating the cathode (the anode is identified by bevelled edges)

### PACKAGING

Supplied in blister tape on reel



SELECTION CHART FOR C <sub>R</sub> , U <sub>R</sub> , AND RELEVANT NOMINAL CASE SIZES (L x W x H in mm)								
C <sub>R</sub> (μF)	U <sub>R</sub> (V)							
	6.3	10	16	25	35	50	63	100
0.47	-	-	-	-	-	4.0 x 4.0 x 5.3	-	-
1.0	-	-	-	-	-	4.0 x 4.0 x 5.3	-	-
2.2	-	-	-	-	-	4.0 x 4.0 x 5.3	-	-
3.3	-	-	-	-	-	4.0 x 4.0 x 5.3	-	-
4.7	-	-	-	-	4.0 x 4.0 x 5.3	5.0 x 5.0 x 5.3	-	-
10	-	-	4.0 x 4.0 x 5.3	-	5.0 x 5.0 x 5.3	6.3 x 6.3 x 5.3	-	-
22	4.0 x 4.0 x 5.3	-	5.0 x 5.0 x 5.3	-	6.3 x 6.3 x 5.3	8.0 x 8.0 x 6.5	-	-
33	-	5.0 x 5.0 x 5.3	-	6.3 x 6.3 x 5.3	8.0 x 8.0 x 6.5	8.0 x 8.0 x 10	-	10 x 10 x 14
47	5.0 x 5.0 x 5.3	-	6.3 x 6.3 x 5.3	8.0 x 8.0 x 6.5	-	8.0 x 8.0 x 10	-	-
100	6.3 x 6.3 x 5.3	-	8.0 x 8.0 x 6.5	8.0 x 8.0 x 10	-	10 x 10 x 10	10 x 10 x 14	-
	-	-	-	-	-	-	-	-
220	-	8.0 x 8.0 x 10	10 x 10 x 10	-	-	-	-	-
330	8.0 x 8.0 x 10	10 x 10 x 10	-	10 x 10 x 14	-	-	-	-
470	10 x 10 x 10	-	10 x 10 x 14	-	-	-	-	-
680	-	10 x 10 x 14	-	-	-	-	-	-
1000	10 x 10 x 14	-	-	-	-	-	-	-

Table 1

TAPE AND REEL DIMENSIONS in millimeters AND PACKAGING QUANTITIES					
CASE CODE	PITCH P <sub>1</sub>	TAPE WIDTH W	TAPE THICKNESS T <sub>2</sub>	REEL DIAMETER	PACKAGING QUANTITY PER REEL
0405	8	12	5.8	380	2000
0505	12	12	5.8	380	1000
0605	12	16	5.8	380	1000
0807	12	16	6.8	380	1000
0810	16	24	11.3	380	500
1010	16	24	11.3	380	500
1014	16	24	14.8	330	250

Note

- Detailed tape dimensions see section "PACKAGING".

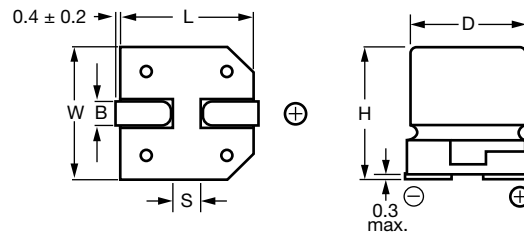

Fig. 2 - Dimensional outline

Table 2

DIMENSIONS in millimeters AND MASS								
NOMINAL CASE SIZE L x W x H	CASE CODE	L <sub>max.</sub>	W <sub>max.</sub>	H <sub>max.</sub>	Ø D	B <sub>max.</sub>	S	MASS (g)
4.0 x 4.0 x 5.3	0405	4.5	4.5	5.5	4.0	0.8	1.0	≈ 0.13
5.0 x 5.0 x 5.3	0505	5.5	5.5	5.5	5.0	0.8	1.4	≈ 0.20
6.3 x 6.3 x 5.3	0605	6.8	6.8	5.5	6.3	0.8	2.0	≈ 0.30
8.0 x 8.0 x 6.5	0807	8.6	8.6	6.8	8.0	0.8	2.3	≈ 0.50
8.0 x 8.0 x 10	0810	8.6	8.6	10.5	8.0	1.1	3.1	≈ 1.00
10 x 10 x 10	1010	10.6	10.6	10.5	10.0	1.1	4.7	≈ 1.30
10 x 10 x 14	1014	10.6	10.6	14.3	10.0	1.2	4.5	≈ 1.50

### MOUNTING

The capacitors are designed for automatic placement on to printed-circuit boards.

Optimum dimensions of soldering pads depend amongst others on soldering method, mounting accuracy, print layout and / or adjacent components.

For recommended soldering pad dimensions, refer to Fig. 3 and Table 3.

### SOLDERING

Soldering conditions are defined by the curve, temperature versus time, where the temperature is that measured on the soldering pad and on top of the case during processing.

For maximum conditions refer to Fig. 4.

Maximum 2 runs with pause of minimum 30 min between.

Any temperature versus time curve which does not exceed the specified maximum curves may be applied.

AS A GENERAL PRINCIPLE, TEMPERATURE AND DURATION SHALL BE THE **MINIMUM** NECESSARY REQUIRED TO ENSURE GOOD SOLDERING CONNECTIONS. HOWEVER, THE SPECIFIED MAXIMUM CURVES SHOULD NEVER BE EXCEEDED.

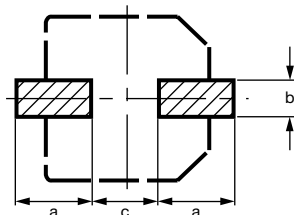

Fig. 3 - Recommended soldering pad dimensions

Table 3

RECOMMENDED SOLDERING PAD DIMENSIONS in millimeters			
CASE CODE	a	b	c
0405	2.6	1.6	1.0
0505	3.0	1.6	1.4
0605	3.5	1.6	1.9
0807	4.0	1.6	2.1
0810	3.5	2.5	3.0
1010	4.0	2.5	4.0
1014	4.3	2.5	4.0

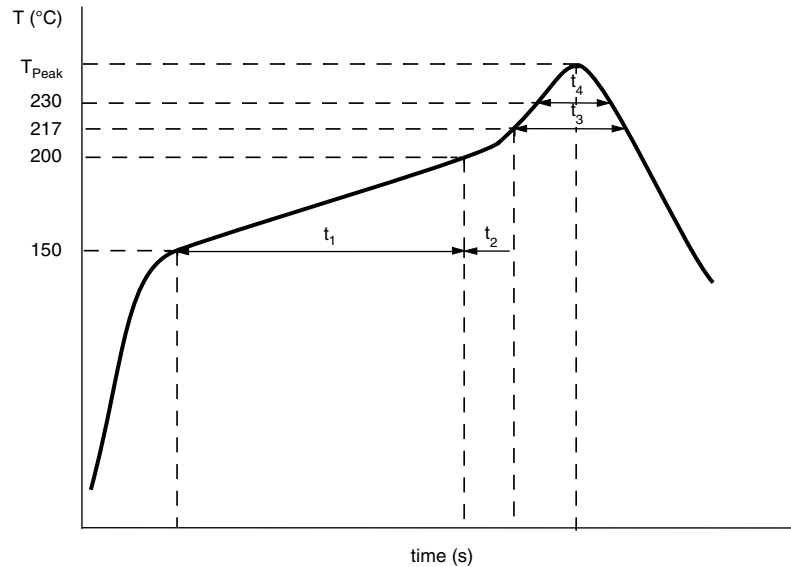

Fig. 4 - Maximum temperature load during reflow soldering measured on capacitors soldering pad and top of the case

REFLOW SOLDERING CONDITIONS				
PROFILE FEATURES	CASE CODE 0405 TO 0605	CASE CODE 0807 TO 1010	CASE CODE 1014 ≤ 63 V	CASE CODE 1014 100 V
Max. time from 25 °C to $T_{peak}$	240 s	240 s	300 s	270 s
Max. ramp-up rate to 150 °C	3 K/s	3 K/s	3 K/s	3 K/s
Max. time from 150 °C to 200 °C ( $t_1$ )	120 s	120 s	150 s	120 s
Ramp up rate from 200 °C to $T_{peak}$	0.5 K/s to 3 K/s	0.5 K/s to 3 K/s	0.5 K/s to 3 K/s	0.5 K/s to 3 K/s
Max. time from 200 °C to 217 °C, ( $t_2$ )	20 s	20 s	60 s	60 s
Max. time above $T_{Liquidus}$ (217 °C), ( $t_3$ )	60 s	60 s	90 s	60 s
Max. time above 230 °C ( $t_4$ )	30 s	20 s	40 s	30 s
Peak temperature $T_{peak}$	250 °C	240 °C	250 °C	240 °C
Max. time above $T_{peak}$ minus 5 °C	5 s	5 s	5 s	10 s
Max. ramp-down rate from $T_{Liquidus}$	6 K/s	6 K/s	6 K/s	6 K/s

**Note**

- Temperature measuring point on top of the case and terminals max. 2 runs with pause of 30 min in between



ELECTRICAL DATA	
SYMBOL	DESCRIPTION
$C_R$	Rated capacitance at 100 Hz or 120 Hz, tolerance $\pm 20\%$
$I_R$	Rated RMS ripple current at 100 Hz or 120 Hz, 105 °C
$I_{L2}$	Max. leakage current after 2 min at $U_R$
$\tan \delta$	Max. dissipation factor at 100 Hz or 120 Hz
ESR	Equivalent series resistance at 100 kHz

**Note**

- Unless otherwise specified, all electrical values in Table 4 apply at  $T_{amb} = 20\text{ °C}$ ,  $P = 86\text{ kPa}$  to  $106\text{ kPa}$ ,  $RH = 45\%$  to  $75\%$ .

Table 4

ELECTRICAL DATA AND ORDERING INFORMATION							
$U_R$ (V)	$C_R$ ( $\mu\text{F}$ )	NOMINAL CASE SIZE L x W x H (mm)	$I_R$ 105 °C (mA)	$I_{L2}$ 2 min ( $\mu\text{A}$ )	$\tan \delta$ 100 Hz	ESR 100 kHz ( $\Omega$ )	ORDERING CODE MAL2153.....
6.3	22	4.0 x 4.0 x 5.3	21	3.0	0.30	8	73229E3
	47	5.0 x 5.0 x 5.3	36	3.0	0.30	4	73479E3
	100	6.3 x 6.3 x 5.3	61	6.3	0.30	2	73101E3
	330	8.0 x 8.0 x 10	180	21	0.30	0.5	73331E3
	470	10 x 10 x 10	320	30	0.30	0.3	73471E3
	1000	10 x 10 x 14	400	63	0.24	0.24	73102E3
10	33	5.0 x 5.0 x 5.3	31	3.3	0.26	4	74339E3
	220	8.0 x 8.0 x 10	180	22	0.26	0.5	74221E3
	330	10 x 10 x 10	320	33	0.26	0.3	74331E3
	680	10 x 10 x 14	380	68	0.19	0.24	74681E3
16	10	4.0 x 4.0 x 5.3	16	3.0	0.22	8	75109E3
	22	5.0 x 5.0 x 5.3	28	3.5	0.22	4	75229E3
	47	6.3 x 6.3 x 5.3	47	7.5	0.22	2.2	75479E3
	100	8.0 x 8.0 x 6.5	110	16	0.22	1.2	75101E3
	220	10 x 10 x 10	320	35	0.22	0.3	75221E3
	470	10 x 10 x 14	370	75	0.16	0.25	75471E3
25	33	6.3 x 6.3 x 5.3	44	8.3	0.16	2.2	76339E3
	47	8.0 x 8.0 x 6.5	110	12	0.16	1.2	76479E3
	100	8.0 x 8.0 x 10	180	22	0.16	0.5	76101E3
	330	10 x 10 x 14	300	83	0.14	0.27	76331E3
35	4.7	4.0 x 4.0 x 5.3	14	3.0	0.13	8	70478E3
	10	5.0 x 5.0 x 5.3	23	3.5	0.13	4	70109E3
	22	6.3 x 6.3 x 5.3	50	7.7	0.13	2.2	70229E3
	33	8.0 x 8.0 x 6.5	110	12	0.13	1.2	70339E3
50	0.47	4.0 x 4.0 x 5.3	5	3.0	0.12	12	71477E3
	1.0	4.0 x 4.0 x 5.3	7	3.0	0.12	12	71108E3
	2.2	4.0 x 4.0 x 5.3	10	3.0	0.12	12	71228E3
	3.3	4.0 x 4.0 x 5.3	12	3.0	0.12	12	71338E3
	4.7	5.0 x 5.0 x 5.3	17	3.0	0.12	6	71478E3
	10	6.3 x 6.3 x 5.3	26	5.0	0.12	3	71109E3
	22	8.0 x 8.0 x 6.5	110	11	0.12	1.2	71229E3
	33	8.0 x 8.0 x 10	180	17	0.12	0.5	71339E3
	47	8.0 x 8.0 x 10	180	24	0.12	0.5	71479E3
	100	10 x 10 x 10	320	50	0.12	0.3	71101E3
63	100	10 x 10 x 14	240	63	0.09	0.34	78101E3
100	33	10 x 10 x 14	170	33	0.07	1.3	79339E3

**ORDERING EXAMPLE**

Electrolytic capacitor 153 CRV series

100  $\mu\text{F}$  / 25 V;  $\pm 20\%$ 

Nominal case size: 8 mm x 8 mm x 10 mm; taped on reel

Ordering code: MAL215376101E3

Former 12NC: 2222 153 76101

ADDITIONAL ELECTRICAL DATA		
PARAMETER	CONDITIONS	VALUE
<b>Voltage</b>		
Surge voltage	IEC 60384-18, subclause 4.14	$U_S \leq 1.15 \times U_R$
Reverse voltage	IEC 60384-18, subclause 4.16	$U_{rev} \leq 1 V$
<b>Current</b>		
Leakage current	After 2 min at $U_R$	$I_{L2} \leq 0.01 \times C_R \times U_R$ or $3 \mu A$ , whichever is greater
<b>Inductance</b>		
Equivalent series inductance (ESL)	Case codes 0405 to 0605	Typ. 10 nH
	Case codes 0807 to 1014	Typ. 15 nH

**CAPACITANCE (C)**

Fig. 5 - Typical multiplier of capacitance at 100 Hz or 120 Hz as a function of ambient temperature

**EQUIVALENT SERIES RESISTANCE (ESR)**

Fig. 6 - Typical ESR as a function of frequency at 20 °C

**DISSIPATION FACTOR (tan δ)**

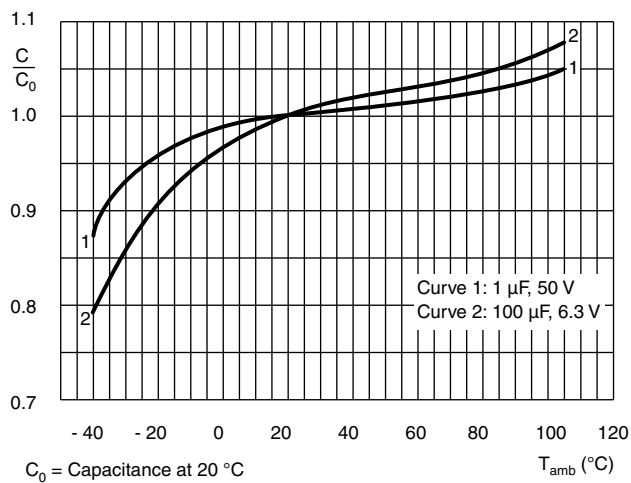
Fig. 7 - Typical dissipation factor (tan δ) at 100 Hz or 120 Hz as a function of ambient temperature

**IMPEDANCE (Z)**

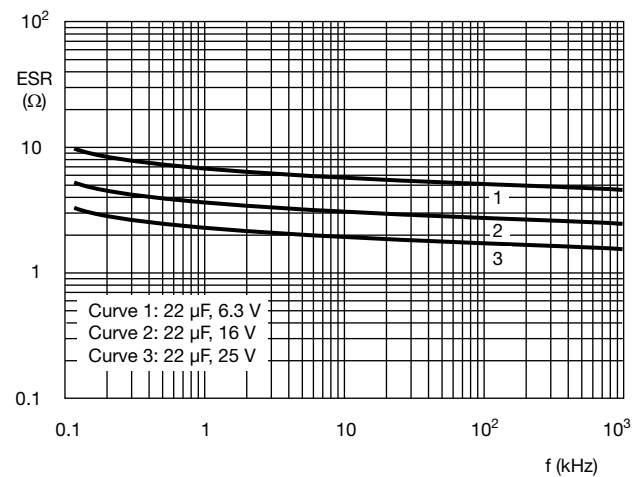
Fig. 8 - Typical impedance as a function of frequency at 20 °C

**RIPPLE CURRENT AND USEFUL LIFE**

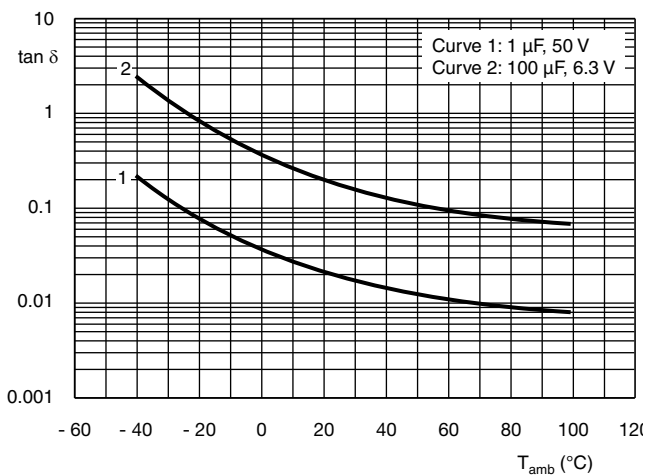
Table 5

ENDURANCE TEST DURATION AND USEFUL LIFE				
NOMINAL CASE SIZE Ø D x L (mm)	ENDURANCE AT 105 °C (h)	USEFUL LIFE AT 105 °C (h)	USEFUL LIFE AT 40 °C 1.3 x I <sub>R</sub> APPLIED (h)	MULTIPLIER OF USEFUL LIFE CODE
4.0 x 4.0 x 5.3	1000	2000	200 000	CCC206r
5.0 x 5.0 x 5.3	1000	2000	200 000	CCC206r
6.3 x 6.3 x 5.3	1000	2000	200 000	CCC206r
8.0 x 8.0 x 6.5	2000	3000	300 000	CCC206r
8.0 x 8.0 x 10	2000	3000	300 000	CCC206r
10 x 10 x 10	2000	3000	300 000	CCC206r
10 x 10 x 14	2000	3000	300 000	CCC206

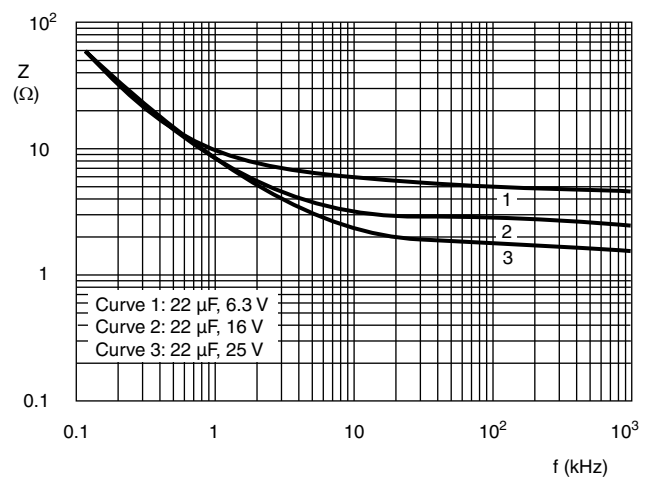
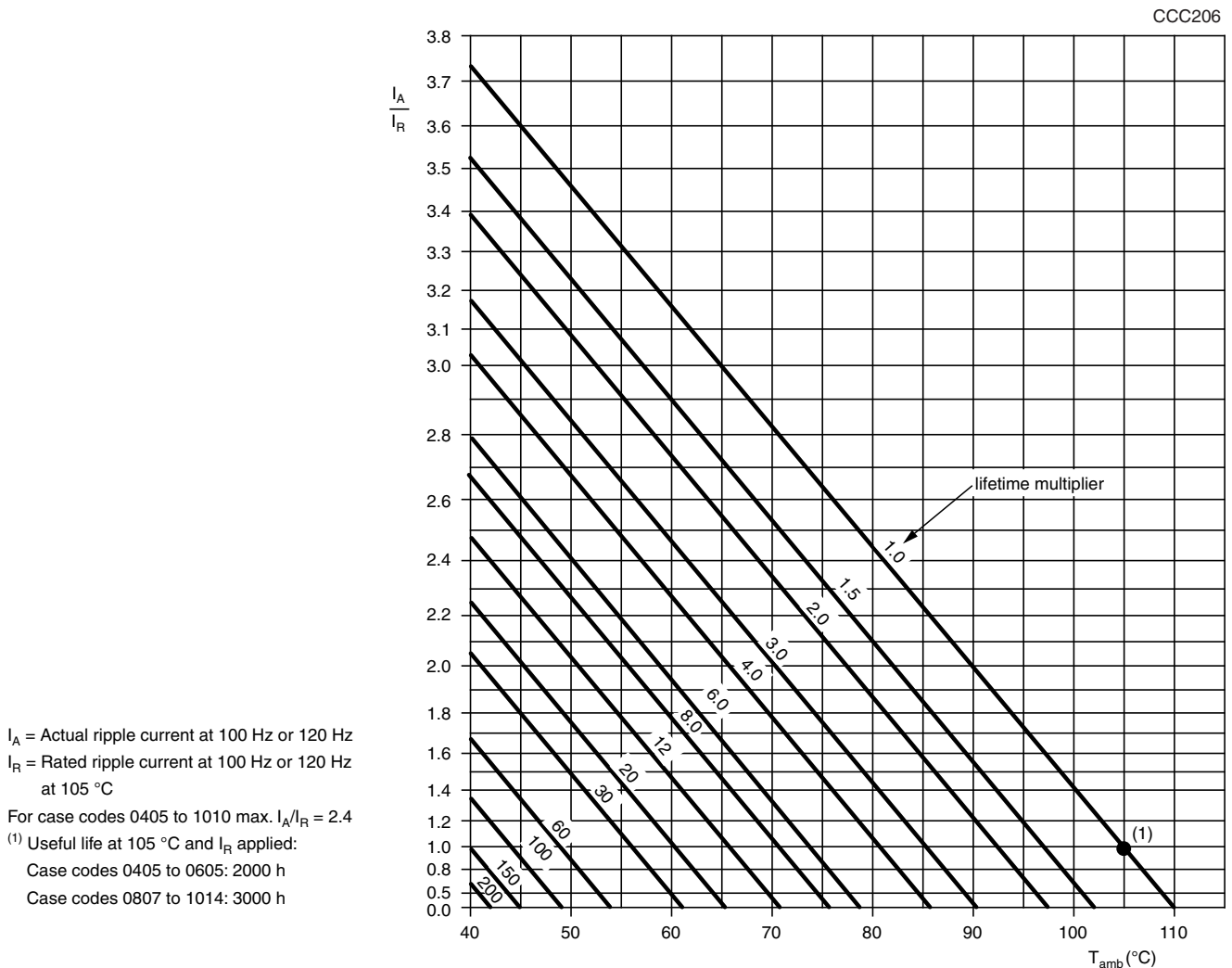

Fig. 9 - Multiplier of useful life as a function of ambient temperature and ripple current load

**Table 6**

<b>MULTIPLIER OF RIPPLE CURRENT (<math>I_R</math>) AS A FUNCTION OF FREQUENCY</b>						
$U_R$ (V)	FREQUENCY (Hz)					
	50	100	300	1000	3000	$\geq 10\ 000$
$I_R$ MULTIPLIER						
6.3	0.80	1.00	1.10	1.15	1.20	1.25
10	0.80	1.00	1.10	1.15	1.20	1.25
16	0.80	1.00	1.10	1.15	1.20	1.25
25	0.80	1.00	1.15	1.25	1.35	1.40
35	0.80	1.00	1.15	1.25	1.35	1.40
50	0.80	1.00	1.20	1.35	1.45	1.50
63	0.80	1.00	1.20	1.35	1.45	1.50
100	0.80	1.00	1.20	1.35	1.45	1.50

**Table 7**

<b>TEST PROCEDURES AND REQUIREMENTS</b>			
TEST		PROCEDURE (quick reference)	REQUIREMENTS
NAME OF TEST	REFERENCE		
Mounting	IEC 60384-18, subclause 4.3	Shall be performed prior to tests mentioned below; reflow soldering; for maximum temperature load refer to chapter "Mounting"	$\Delta C/C: \pm 10\ %$ $\tan \delta \leq \text{spec. limit}$ $I_{L2} \leq \text{spec. limit}$
Endurance	IEC 60384-18 / CECC 32300, subclause 4.15	$T_{\text{amb}} = 105\ ^\circ\text{C}$ ; $U_R$ applied; 1000 h, case codes 0405 to 0605 2000 h, case codes 0807 to 1014	$\Delta C/C: \pm 20\ %$ $\tan \delta \leq 2 \times \text{spec. limit}$ $I_{L2} \leq \text{spec. limit}$
Useful life	CECC 30301, subclause 1.8.1	$T_{\text{amb}} = 105\ ^\circ\text{C}$ ; $U_R$ and $I_R$ applied; 2000 h, case codes 0405 to 0605 3000 h, case codes 0807 to 1014	$\Delta C/C: \pm 50\ %$ $\tan \delta \leq 3 \times \text{spec. limit}$ $I_{L2} \leq \text{spec. limit}$ no short or open circuit total failure percentage: $\leq 1\ %$
Shelf life (storage at high temperature)	IEC 60384-18 / CECC 32300, subclause 4.17	$T_{\text{amb}} = 105\ ^\circ\text{C}$ ; no voltage applied; 1000 h After test: $U_R$ to be applied for 30 min, 24 h to 48 h before measurement	For requirements see "Endurance test" above

Statements about product lifetime are based on calculations and internal testing. They should only be interpreted as estimations. Also due to external factors, the lifetime in the field application may deviate from the calculated lifetime. In general, nothing stated herein shall be construed as a guarantee of durability.





## Disclaimer

ALL PRODUCT, PRODUCT SPECIFICATIONS AND DATA ARE SUBJECT TO CHANGE WITHOUT NOTICE TO IMPROVE RELIABILITY, FUNCTION OR DESIGN OR OTHERWISE.

Vishay Intertechnology, Inc., its affiliates, agents, and employees, and all persons acting on its or their behalf (collectively, "Vishay"), disclaim any and all liability for any errors, inaccuracies or incompleteness contained in any datasheet or in any other disclosure relating to any product.

Vishay makes no warranty, representation or guarantee regarding the suitability of the products for any particular purpose or the continuing production of any product. To the maximum extent permitted by applicable law, Vishay disclaims (i) any and all liability arising out of the application or use of any product, (ii) any and all liability, including without limitation special, consequential or incidental damages, and (iii) any and all implied warranties, including warranties of fitness for particular purpose, non-infringement and merchantability.

Statements regarding the suitability of products for certain types of applications are based on Vishay's knowledge of typical requirements that are often placed on Vishay products in generic applications. Such statements are not binding statements about the suitability of products for a particular application. It is the customer's responsibility to validate that a particular product with the properties described in the product specification is suitable for use in a particular application. Parameters provided in datasheets and / or specifications may vary in different applications and performance may vary over time. All operating parameters, including typical parameters, must be validated for each customer application by the customer's technical experts. Product specifications do not expand or otherwise modify Vishay's terms and conditions of purchase, including but not limited to the warranty expressed therein.

Hyperlinks included in this datasheet may direct users to third-party websites. These links are provided as a convenience and for informational purposes only. Inclusion of these hyperlinks does not constitute an endorsement or an approval by Vishay of any of the products, services or opinions of the corporation, organization or individual associated with the third-party website. Vishay disclaims any and all liability and bears no responsibility for the accuracy, legality or content of the third-party website or for that of subsequent links.

Except as expressly indicated in writing, Vishay products are not designed for use in medical, life-saving, or life-sustaining applications or for any other application in which the failure of the Vishay product could result in personal injury or death. Customers using or selling Vishay products not expressly indicated for use in such applications do so at their own risk. Please contact authorized Vishay personnel to obtain written terms and conditions regarding products designed for such applications.

No license, express or implied, by estoppel or otherwise, to any intellectual property rights is granted by this document or by any conduct of Vishay. Product names and markings noted herein may be trademarks of their respective owners.