

54012-1 ✓ ACTIVE

AMP | AMP CPC

TE Internal #: 54012-1

Cable Seal, Black, -55 – 110 °C [-67 – 230 °F] Operating Temperature, AMP CPC

[View on TE.com >](#)



Connectors > Connector Accessories > Connector Seals & Cavity Plugs > CPC Heat Shrink Strain Reliefs



Connector Seal & Plug Type: **Cable Seal**

Primary Product Color: **Black**

Operating Temperature (Max): **110 °C [230 °F]**

Operating Temperature Range: **-55 – 110 °C [-67 – 230 °F]**

[All CPC Heat Shrink Strain Reliefs \(7\)](#)

Features

Product Type Features

Connector Seal & Plug Type	Cable Seal
----------------------------	------------

Body Features

Primary Product Color	Black
-----------------------	-------

Mechanical Attachment

Thread Size	1-3/8-18
-------------	----------

Dimensions

Compatible Cable Diameter Range	13.97 – 31.75 mm [.55 – 1.25 in]
---------------------------------	----------------------------------

Usage Conditions

Operating Temperature (Max)	110 °C [230 °F]
Operating Temperature Range	-55 – 110 °C [-67 – 230 °F]

Packaging Features

Packaging Quantity	50
Packaging Method	Package

Product Compliance

[For compliance documentation, visit the product page on TE.com>](#)

EU RoHS Directive 2011/65/EU	Compliant
EU ELV Directive 2000/53/EC	Compliant
China RoHS 2 Directive MIIT Order No 32, 2016	No Restricted Materials Above Threshold
EU REACH Regulation (EC) No. 1907/2006	Current ECHA Candidate List: JUNE 2023 (235) Candidate List Declared Against: JUNE 2022 (224) Does not contain REACH SVHC
Halogen Content	Low Halogen - Br, Cl, F, I < 900 ppm per homogenous material. Also BFR/CFR/PVC Free
Solder Process Capability	Not applicable for solder process capability

Product Compliance Disclaimer

This information is provided based on reasonable inquiry of our suppliers and represents our current actual knowledge based on the information they provided. This information is subject to change. The part numbers that TE has identified as EU RoHS compliant have a maximum concentration of 0.1% by weight in homogenous materials for lead, hexavalent chromium, mercury, PBB, PBDE, DBP, BBP, DEHP, DIBP, and 0.01% for cadmium, or qualify for an exemption to these limits as defined in the Annexes of Directive 2011/65/EU (RoHS2). Finished electrical and electronic equipment products will be CE marked as required by Directive 2011/65/EU. Components may not be CE marked. Additionally, the part numbers that TE has identified as EU ELV compliant have a maximum concentration of 0.1% by weight in homogenous materials for lead, hexavalent chromium, and mercury, and 0.01% for cadmium, or qualify for an exemption to these limits as defined in the Annexes of Directive 2000/53/EC (ELV). Regarding the REACH Regulation, the information TE provides on SVHC in articles for this part number is based on the latest European Chemicals Agency (ECHA) 'Guidance on requirements for substances in articles' posted at this URL: <https://echa.europa.eu/guidance-documents/guidance-on-reach>

Compatible Parts

 <p>TE Part # CAT-AM71-C83998Y One-Piece Connector, Sealed, CPC Series 1</p>	 <p>TE Part # CAT-AM71-C83998J Cable/Panel Mount Connector, CPC Series 1</p>	 <p>TE Part # 206838-3 CPC RECPT SEALED SIZE 23-24</p>	 <p>TE Part # CAT-AM71-C83998BB CPC SERIES 3</p>
---	--	---	---



TE Part # 206437-1
CPC PLUG ASSEMBLY SIZE 23-57



TE Part # CAT-AM71-C83998K
Circular Connector, Environmentally Sealed, CPC Series 6



TE Part # CAT-AM71-C83998CC
CPC Connector Housing, Series 4

Also in the Series | AMP CPC

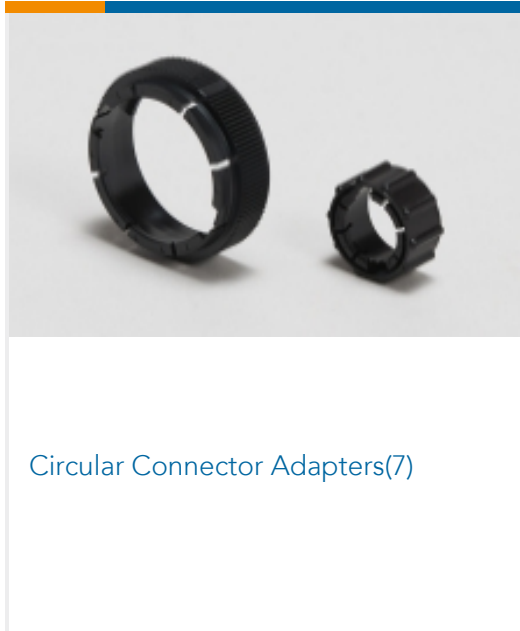

Circular Connector Adapters(7)

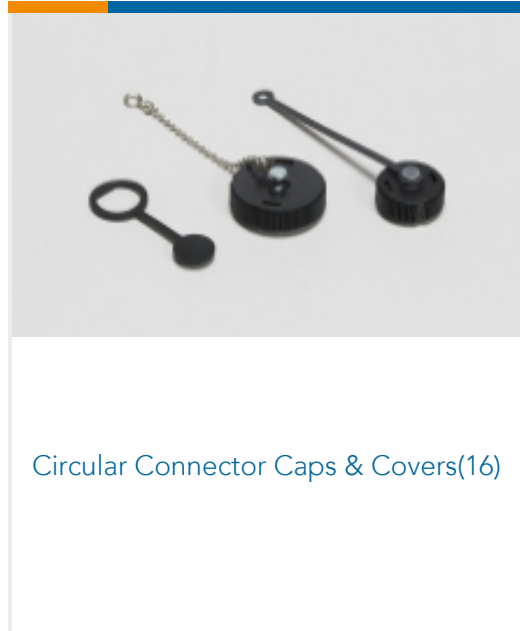

Circular Connector Caps & Covers(16)

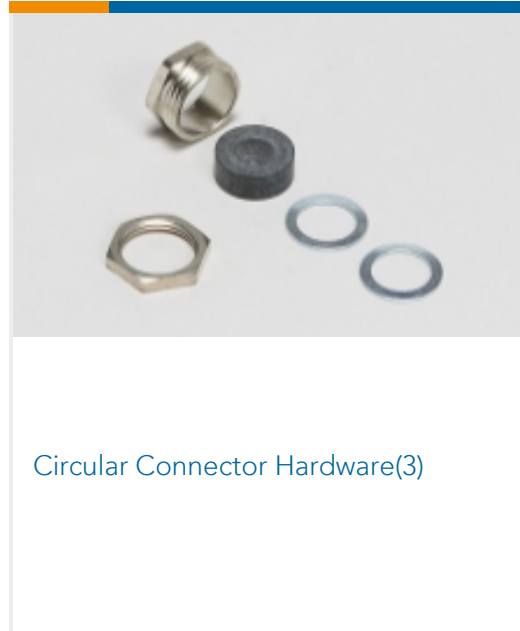

Circular Connector Hardware(3)



Circular Connector Keying Plugs(2)

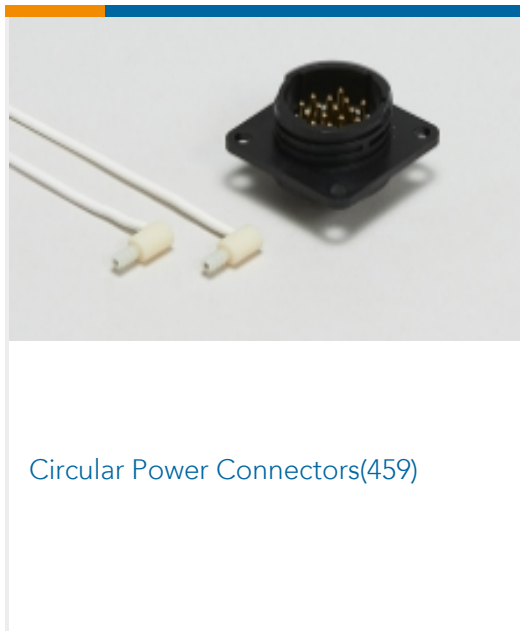

Circular Power Connectors(459)



Connector Backshells(56)

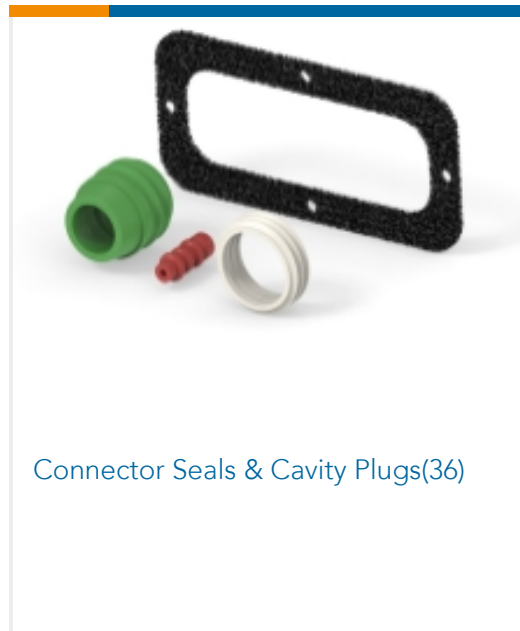

Connector Seals & Cavity Plugs(36)

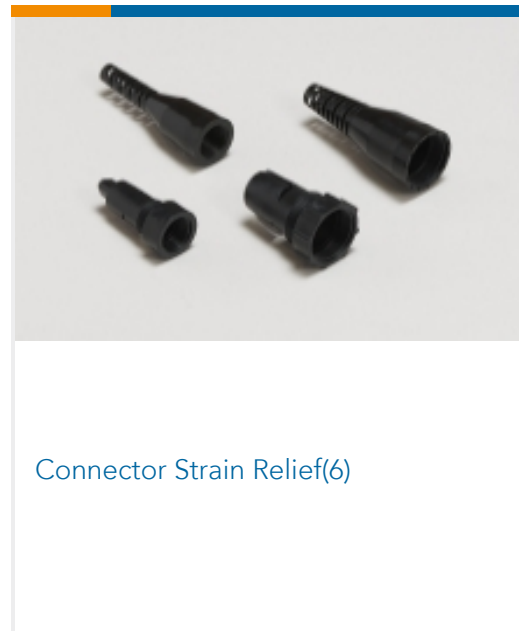

Connector Strain Relief(6)

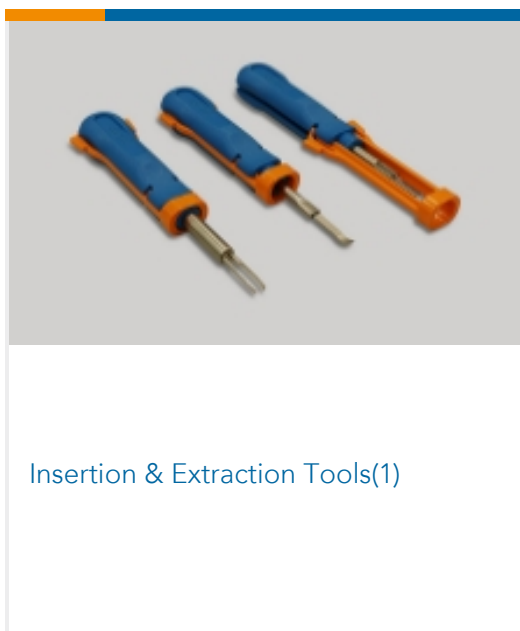

Insertion & Extraction Tools(1)

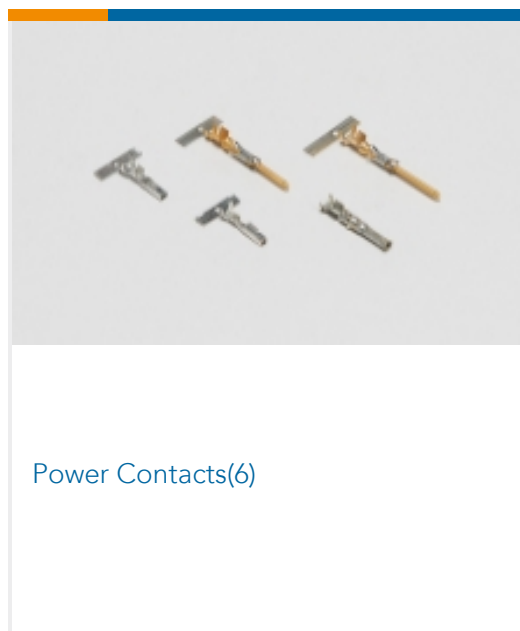

Power Contacts(6)

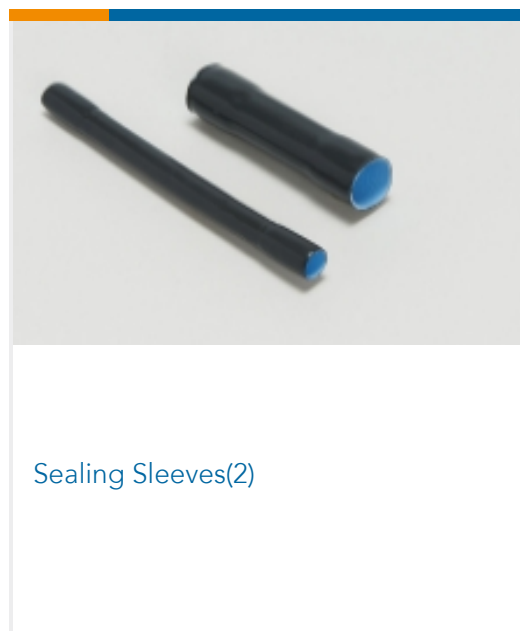

Sealing Sleeves(2)

Customers Also Bought



TE Part #206207-1
17-3 RECEPT. FREE-HANGING



TE Part #206150-1
CPC PLUG ASSEMBLY SIZE 23-37

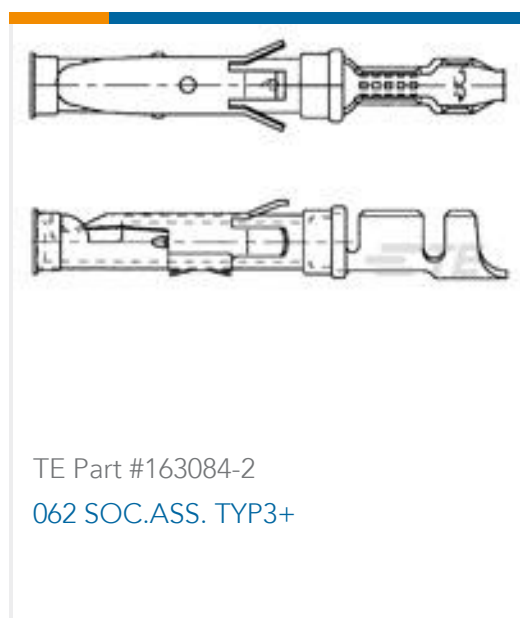

TE Part #163084-2
062 SOC.ASS. TYP3+



TE Part #66261-2
MALE CONTACT ASSY. (L.P.)



Documents

Product Drawings

CPC STRAIN RELIEF, SIZE 23

English

CAD Files

3D PDF

3D

Customer View Model

[ENG_CVM_CVM_54012-1_Y.2d_dxf.zip](#)

English

Customer View Model

[ENG_CVM_CVM_54012-1_Y.3d_igs.zip](#)

English

Customer View Model

[ENG_CVM_CVM_54012-1_Y.3d_stp.zip](#)

English

3D PDF

English

Customer View Model

[ENG_CVM_54012-1_V.2d_dxf.zip](#)

English

Customer View Model

[ENG_CVM_54012-1_V.3d_igs.zip](#)

English

Customer View Model

[ENG_CVM_54012-1_V.3d_stp.zip](#)

English



By downloading the CAD file I accept and agree to the [Terms and Conditions](#) of use.

Datasheets & Catalog Pages

[AMP Circular Connectors for Commercial Signal & Power Applications Continued](#)

English

Product Environmental Compliance

[Product Compliance](#)

English

[Product Compliance](#)

English

Instruction Sheets

[Instruction Sheet \(U.S.\)](#)

English

Agency Approvals

[CSA Certificate](#)

English

[CSA Certificate](#)

English