

REFERENCE SPECIFICATIONS

-NFC 93425 (in compliance with HE 508)

PHYSICAL CHARACTERISTICS

- INSULATOR MATERIAL: THERMOSET UL94V0
- CONTACT MATERIAL: BRASS
GOLD OVER NICKEL
- ACCESSORIES: STEEL FOR METAL BRACKETS
Cadmium plated, yellow passivation
THERMOPLASTIC UL94V0 FOR PLASTIC BRACKETS
BRASS FOR OTHERS ACCESSORIES
Cadmium plated, yellow passivation
- SHELLS: STEEL
Cadmium plated, yellow passivation

ELECTRICAL CHARACTERISTICS

- NOMINAL CURRENT: 7.5A
- CONTACT RESISTANCE: <=7.3 m Ohms
- CONTACT/CONTACT : >=1000 V
- CONTACT/GROUND : >=1200 V
- INSULATION RESISTANCE: >=5000 MOhms

ENVIRONMENTAL CHARACTERISTICS

- CLIMATIC CATEGORY: 55/155/56
TEMPERATURE RANGE -55°C TO +155°C
DAMP HEAT STEADY STATE 56 DAYS
SALT SPRAY 48 HOURS

MECHANICAL CHARACTERISTICS

- RETENTION AGAINST TORQUE: -Threaded insert:0.7 N.m min
-Female screw:0.5 N.m min

DBML25P500MN

Series

Shell size: **E A B C D**
(see sheet 3)

Front accessory definition
(see sheet 2)

- Blank** :without accessory
- L** :threaded insert M3
- O** :threaded insert UNC 4-40
- V** :female screw UNC 4-40

Layout of contacts (see sheet 3)

9,15,25,37,50

Contacts

- P** :Pin

Termination type

- 5** Right angle/Europe standard

Plating

- 00** Right angle 500 matings/unmatings
- 43** Right angle 500 matings/unmatings
for harsh environment

PCB accessories definition(see sheet 2)

- Blank** :Plastic brackets
- C** :Without brackets
- M** :Metal brackets

Obligatory for HE508

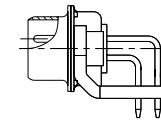
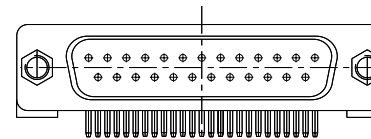

25 WAY FOR EXAMPLE

rev	ccn no	dr	date
A	LS08-0014	MPE	2006/11/14
B	LS08-0014	-	2008/01/17
-	-	-	-
-	-	-	-
-	-	-	-
-	-	-	-

www.fciconnect.com		surface	ISO 1302	tolerance std	ISO 406	ISO 1101	projection	mm
		TOLERANCES UNLESS OTHERWISE SPECIFIED					mm	
Dr	M PESSON	2006/11/14	ANGULAR	0.X	±0.3	size	A2	Scale
Eng	P LEGARE	2006/11/14	LINEAR	0.XX	±0.1	ECN	LS08-0014	2:1
Chr	P LEGARE	2006/11/14	0° ±2°	0.XXX	±0.05	Spec ref		
Appr	P LEGARE	2006/11/14	Product family		SUB MALE DM HE508 series		ang no	C01-8637-1744
				with right angle contact		Rev.	B	
				catalog no		CUSTOMER		sheet 1 of 9

Copyright FCi.

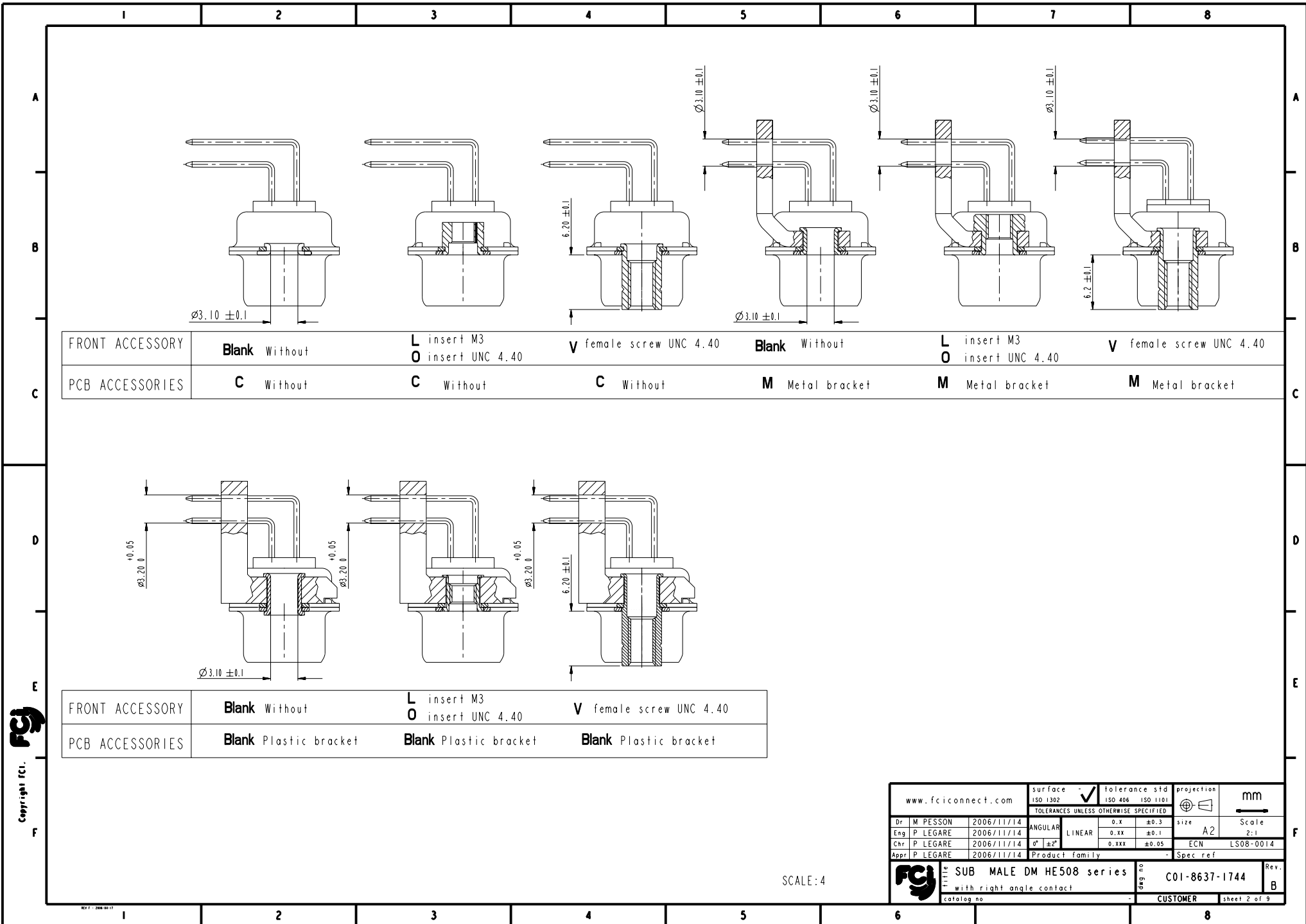

FRONT ACCESSORY	Blank Without	L insert M3 O insert UNC 4.40	V female screw UNC 4.40	Blank Without	L insert M3 O insert UNC 4.40	V female screw UNC 4.40
PCB ACCESSORIES	C Without	C Without	C Without	M Metal bracket	M Metal bracket	M Metal bracket

FRONT ACCESSORY	Blank Without	L insert M3 O insert UNC 4.40	V female screw UNC 4.40
PCB ACCESSORIES	Blank Plastic bracket	Blank Plastic bracket	Blank Plastic bracket

www.fciconnect.com		surface - ISO 1302	tolerance std ISO 406 ISO 1101	projection mm
		TOLERANCES UNLESS OTHERWISE SPECIFIED		
Dr	M PESSON	2006/11/14	ANGULAR	0.X ±0.3
Eng	P LEGARE	2006/11/14	LINEAR	0.XX ±0.1
Chr	P LEGARE	2006/11/14	0° ±2°	0.XXX ±0.05
Appr	P LEGARE	2006/11/14	Product family	- Spec ref
SUB MALE DM HE508 series		ang no	C01-8637-1744	
with right angle contact		Rev.	B	
catalog no		CUSTOMER		sheet 2 of 9

SCALE: 4

Copyright fci.

PART NUMBER	FRONT ACCESSORY	PCB ACCESSORY
D*MxxP500CN	without	without
D*MLxxP500CN	insert M3	without
D*MOxxP500CN	insert UNC 4.40	without
D*MVxxP500CN	female screw UNC 4.40	without
D*MxxP500MN	without	Metal bracket
D*MLxxP500MN	insert M3	Metal bracket
D*MOxxP500MN	insert UNC 4.40	Metal bracket
D*MVxxP500MN	female screw UNC 4.40	Metal bracket
D*MxxP500N	without	Plastic bracket
D*MLxxP500N	insert M3	Plastic bracket
D*MOxxP500N	insert UNC 4.40	Plastic bracket
D*MVxxP500N	female screw UNC 4.40	Plastic bracket

shell size	Contact number
X	09
E	15
A	25
B	37
C	50
D	

PART NUMBER	FRONT ACCESSORY	PCB ACCESSORY
D*MxxP543CN	without	without
D*MLxxP543CN	insert M3	without
D*MOxxP543CN	insert UNC 4.40	without
D*MVxxP543CN	female screw UNC 4.40	without
D*MxxP543MN	without	Metal bracket
D*MLxxP543MN	insert M3	Metal bracket
D*MOxxP543MN	insert UNC 4.40	Metal bracket
D*MVxxP543MN	female screw UNC 4.40	Metal bracket
D*MxxP543N	without	Plastic bracket
D*MLxxP543N	insert M3	Plastic bracket
D*MOxxP543N	insert UNC 4.40	Plastic bracket
D*MVxxP543N	female screw UNC 4.40	Plastic bracket

CROSS REFERENCES HE501 and FCI

HE508 P/N	FCI P/N	FRONT ACCESSORY	PCB ACCESSORY
HE508PxxVP6	D*MxxP500N	without	Plastic bracket
HE508MxxVP6	D*MxxP500MN	without	Metal bracket

Copyright FCI

www.fciconnect.com		surface - ISO 1302	tolerance std ISO 406 ISO 1101	projection mm
		TOLERANCES UNLESS OTHERWISE SPECIFIED		
Dr M PESSON	2006/11/14	ANGULAR	0.X ±0.3	size A2 Scale 2:1
Eng P LEGARE	2006/11/14	LINEAR	0.XX ±0.1	ECN LS08-0014
Chr P LEGARE	2006/11/14	Ø ±2	0.XXX ±0.05	
Appr P LEGARE	2006/11/14	Product family	Spec ref	
SUB MALE DM HE508 series		ang no	C01-8637-1744	
with right angle contact		Rev.	B	
catalog no		CUSTOMER	sheet 3 of 9	

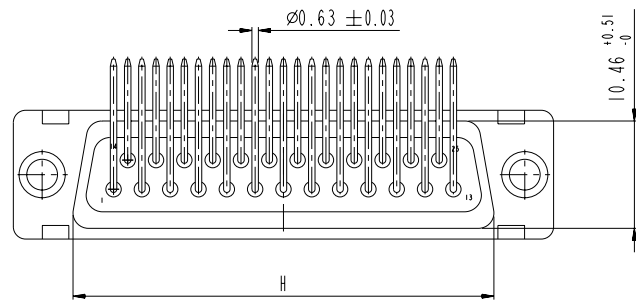

DIMENSION FOR SHELL E,A,B,C WITHOUT BRACKET

Dimensions are in millimeters

Shell size	Number of contacts	A ^{+0.76} ₋₀	B ^{+0.25} ₋₀	C ±0.12	F ^{+0.57} ₋₀	G ^{+0.25} ₋₀	H ^{+0.51} ₋₀	L ^{+0.22} ₋₀
E	09	30.43	16.79	24.99	10.47	5.9 ^{+0.15} ₋₀	19.02	0.80
A	15	38.76	25.12	33.32	10.47	5.9 ^{+0.15} ₋₀	27.25	0.80
B	25	52.65	38.84	47.04	10.43	5.7 ^{+0.25} ₋₀	41.02	0.80
C	37	68.94	55.30	63.50	10.56	5.7 ^{+0.25} ₋₀	57.45	0.90

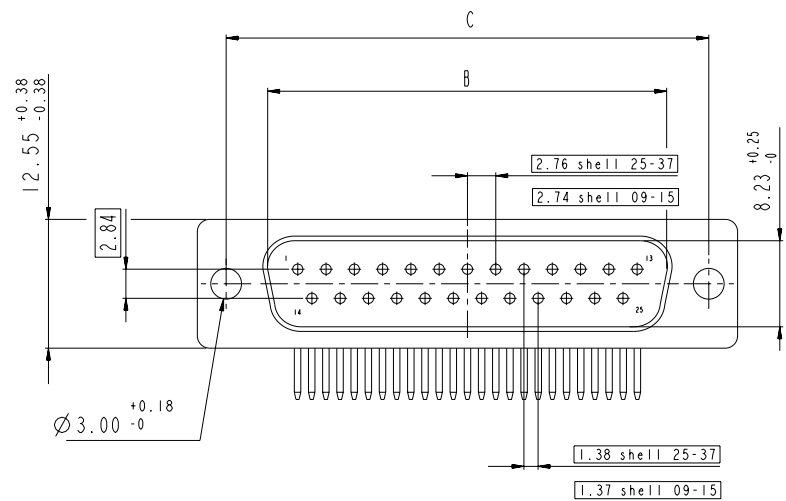
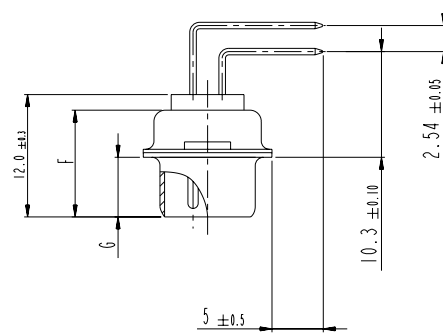
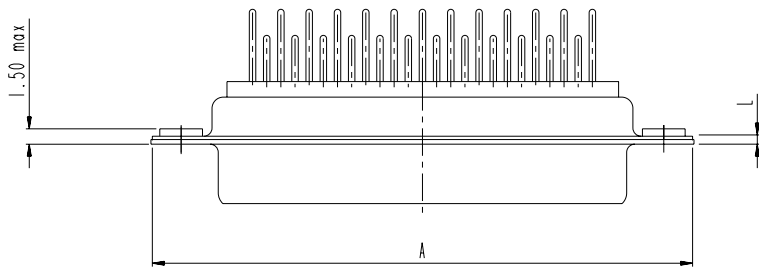

LAYOUT DIMENSIONS

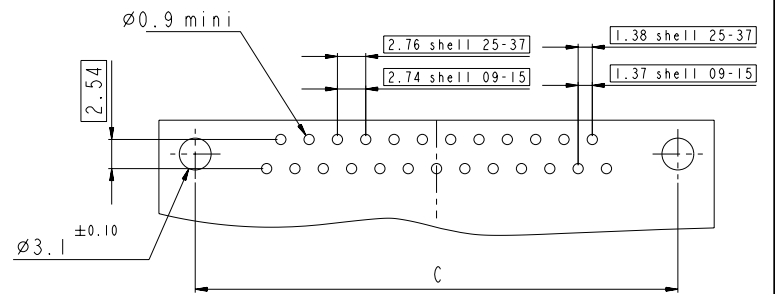

SCALE: 3

www.fciconnect.com		surface - ISO 1302	tolerance std ISO 406 ISO 1101	projection mm
		TOLERANCES UNLESS OTHERWISE SPECIFIED		
Dr M PESSON	2006/11/14	ANGULAR	0.X ±0.3	size A2 Scale 2:1
Eng P LEGARE	2006/11/14	LINEAR	0.XX ±0.1	ECN LS08-0014
Chr P LEGARE	2006/11/14	0° ±2°	0.XXX ±0.05	
Appr P LEGARE	2006/11/14	Product family	-	Spec ref
SUB MALE DM HE508 series		ang no	C01-8637-1744	Rev. B
with right angle contact		catalog no	CUSTOMER	sheet 4 of 9

Copyright fci. FCJ

DIMENSION FOR SHELL E, A, B, C WITH METAL BRACKET

Dimensions are in millimeters

Shell size	Number of contacts	A ^{+0.76} ₋₀	B ^{+0.25} ₋₀	C ±0.12	F ^{+0.57} ₋₀	G ^{+0.25} ₋₀	H ^{+0.51} ₋₀	L ^{+0.22} ₋₀
E	09	30.43	16.79	24.99	10.47	5.9 ^{+0.15} ₋₀	19.02	0.80
A	15	38.76	25.12	33.32	10.47	5.9 ^{+0.15} ₋₀	27.25	0.80
B	25	52.65	38.84	47.04	10.43	5.7 ^{+0.25} ₋₀	41.02	0.80
C	37	68.94	55.30	63.50	10.56	5.7 ^{+0.25} ₋₀	57.45	0.90

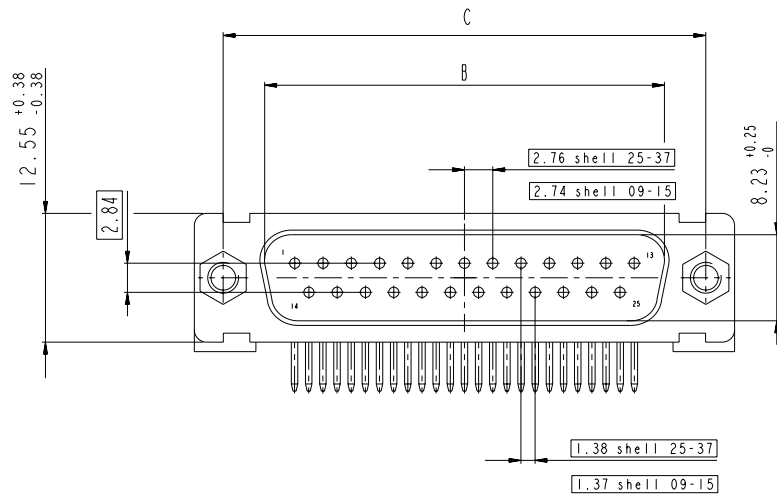
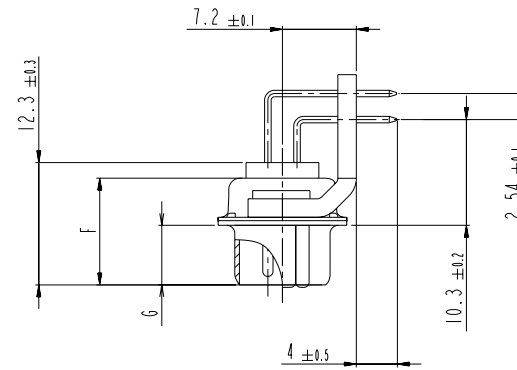
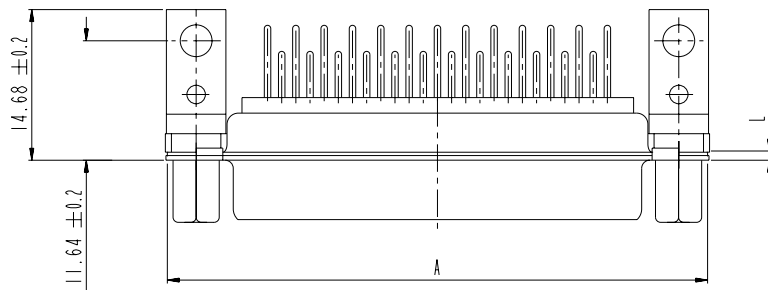
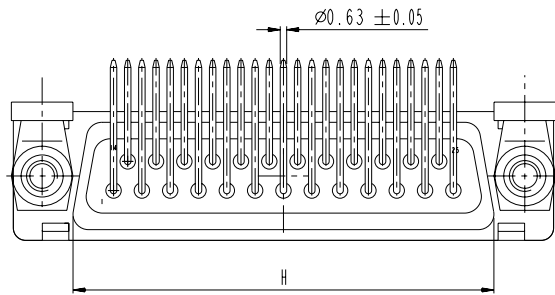

LAYOUT DIMENSIONS

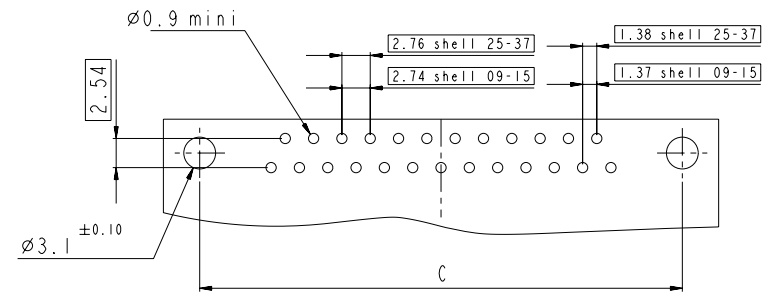

SCALE: 3

www.fciconnect.com		surface - ISO 1302	tolerance std ISO 406 ISO 1101	projection mm
		TOLERANCES UNLESS OTHERWISE SPECIFIED		
Dr M PESSON	2006/11/14	ANGULAR	0.X ±0.3	size A2 Scale 2:1
Eng P LEGARE	2006/11/14	LINEAR	0.XX ±0.1	ECN LS08-0014
Chr P LEGARE	2006/11/14	° ±2'	0.XXX ±0.05	
Appr P LEGARE	2006/11/14	Product family	-	Spec ref
SUB MALE DM HE508 series		ang no	C01-8637-1744	
with right angle contact		Rev.	B	
catalog no		CUSTOMER		sheet 5 of 9

Copyright fci. FCJ

DIMENSION FOR SHELL E,A,B,C WITH PLASTIC BRACKET

Dimensions are in millimeters

Shell size	Number of contacts	A ^{+0.76} ₋₀	B ^{+0.25} ₋₀	C ±0.12	F ^{+0.57} ₋₀	G ^{+0.25} ₋₀	H ^{+0.51} ₋₀	L ^{+0.22} ₋₀
E	09	30.43	16.79	24.99	10.47	5.9 ^{+0.15} ₋₀	19.02	0.80
A	15	38.76	25.12	33.32	10.47	5.9 ^{+0.15} ₋₀	27.25	0.80
B	25	52.65	38.84	47.04	10.43	5.7 ^{+0.25} ₋₀	41.02	0.80
C	37	68.94	55.30	63.50	10.56	5.7 ^{+0.25} ₋₀	57.45	0.90

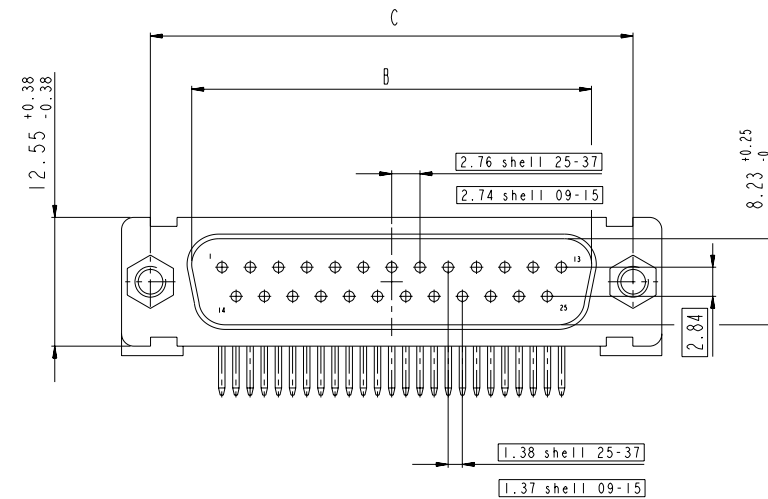
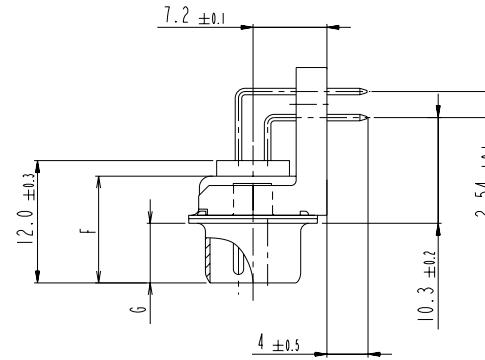
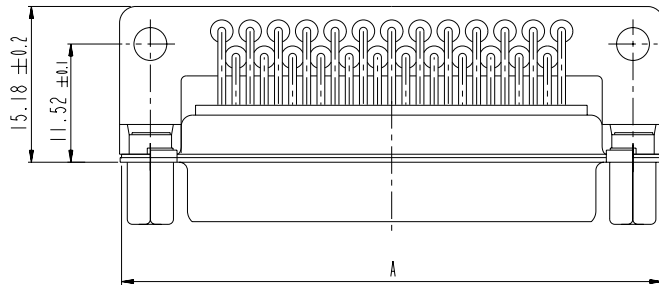
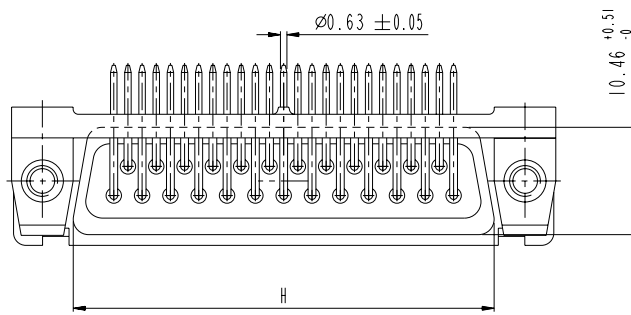

LAYOUT DIMENSIONS

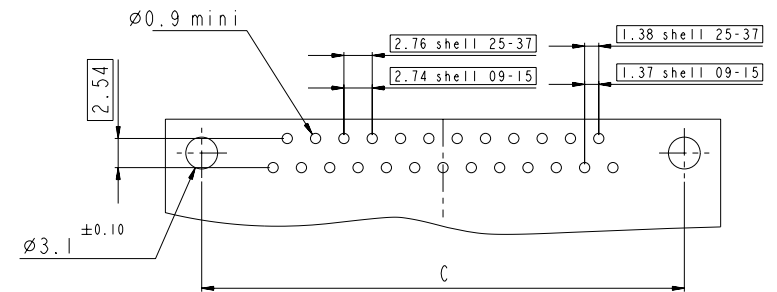

www.fciconnect.com		surface - ISO 1302	tolerance std ISO 406 ISO 1101	projection mm
		TOLERANCES UNLESS OTHERWISE SPECIFIED		
Dr M PESSON	2006/11/14	ANGULAR	0.X ±0.3	size A2 Scale 2:1
Eng P LEGARE	2006/11/14	LINEAR	0.XX ±0.1	ECN LS08-0014
Chr P LEGARE	2006/11/14	° ±2'	0.XXX ±0.05	
Appr P LEGARE	2006/11/14	Product family	-	Spec ref
SUB MALE DM HE508 series		ang no	C01-8637-1744	
with right angle contact		Rev.	B	
catalog no		CUSTOMER		sheet 6 of 9

Copyright fci. FCJ

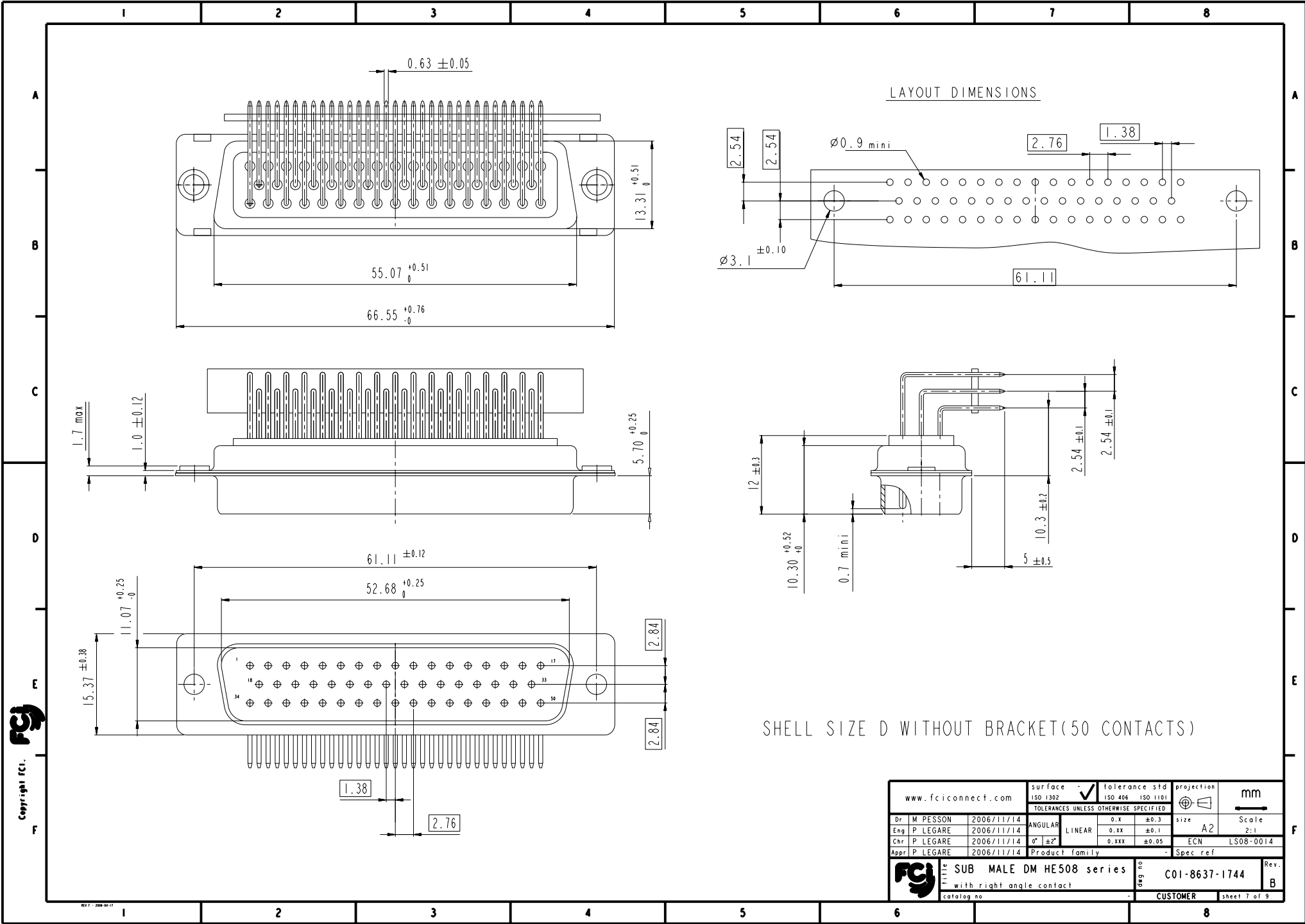

Copyright fci. **fci**

www.fciconnect.com		surface - ISO 1302	tolerance std ISO 406 ISO 1101	projection mm
		TOLERANCES UNLESS OTHERWISE SPECIFIED		
Dr M PESSON	2006/11/14	ANGULAR	0.X ±0.3	size A2 Scale 2:1
Eng P LEGARE	2006/11/14	LINEAR	0.XX ±0.1	ECN LS08-0014
Chr P LEGARE	2006/11/14	° ±2	0.XXX ±0.05	
Appr P LEGARE	2006/11/14	Product family	-	Spec ref
fci SUB MALE DM HE508 series		ang no	C01-8637-1744	
with right angle contact		Rev.	B	
catalog no		CUSTOMER	sheet 7 of 9	

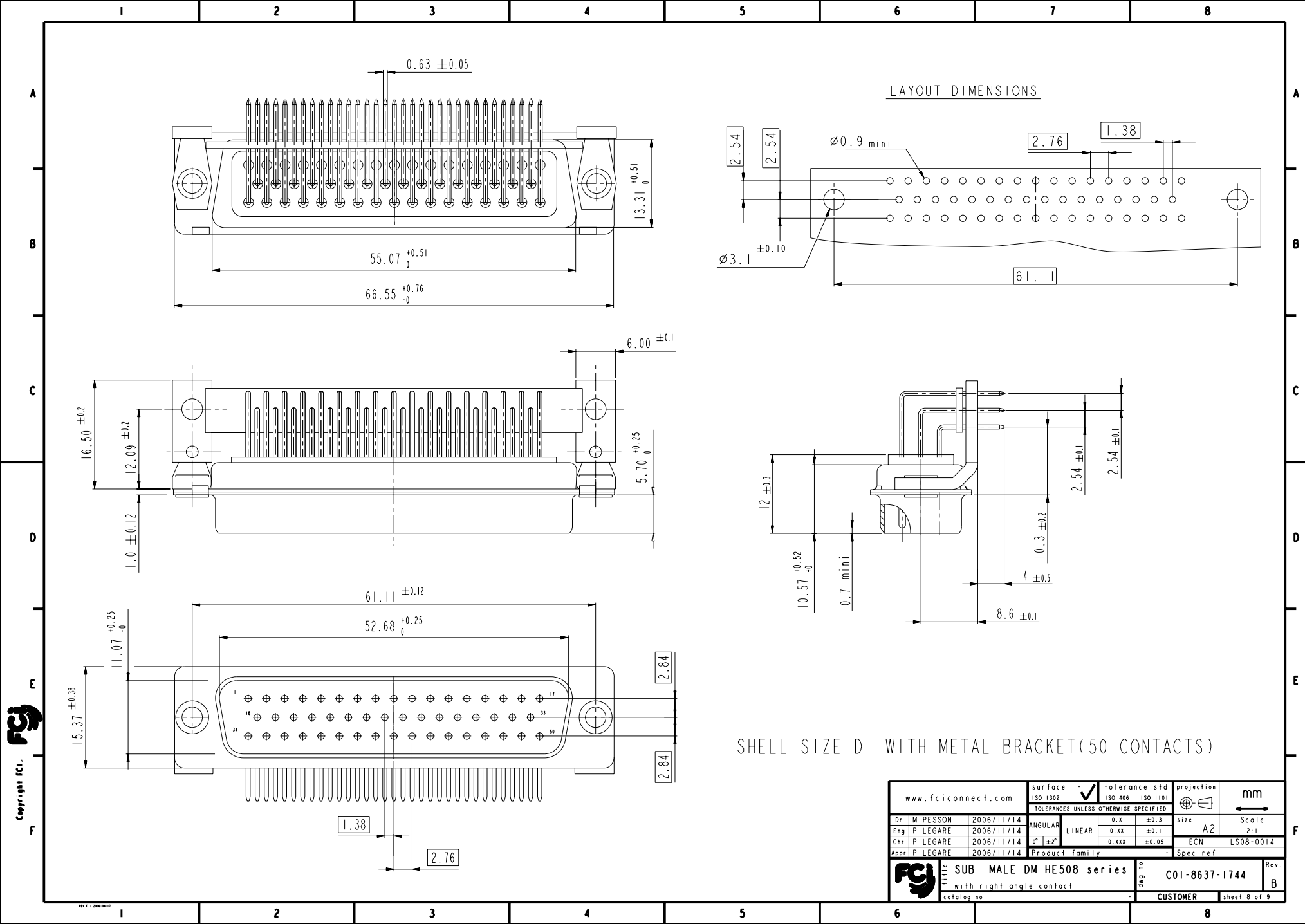

SHELL SIZE D WITH METAL BRACKET(50 CONTACTS)

www.fciconnect.com		surface - ISO 1302	tolerance std ISO 406 ISO 1101	projection mm
		TOLERANCES UNLESS OTHERWISE SPECIFIED		
Dr M PESSON	2006/11/14	ANGULAR	0.X ± 0.3	size A2
Eng P LEGARE	2006/11/14	LINEAR	0.XX ± 0.1	Scale 2:1
Chr P LEGARE	2006/11/14	Ø ± 0.2	0.XXX ± 0.05	ECN LS08-0014
Appr P LEGARE	2006/11/14	Product family	-	Spec ref
TITLE SUB MALE DM HE508 series with right angle contact catalog no		dwg no C01-8637-1744 Rev. B	CUSTOMER sheet 8 of 9	

Copyright fci. FCI

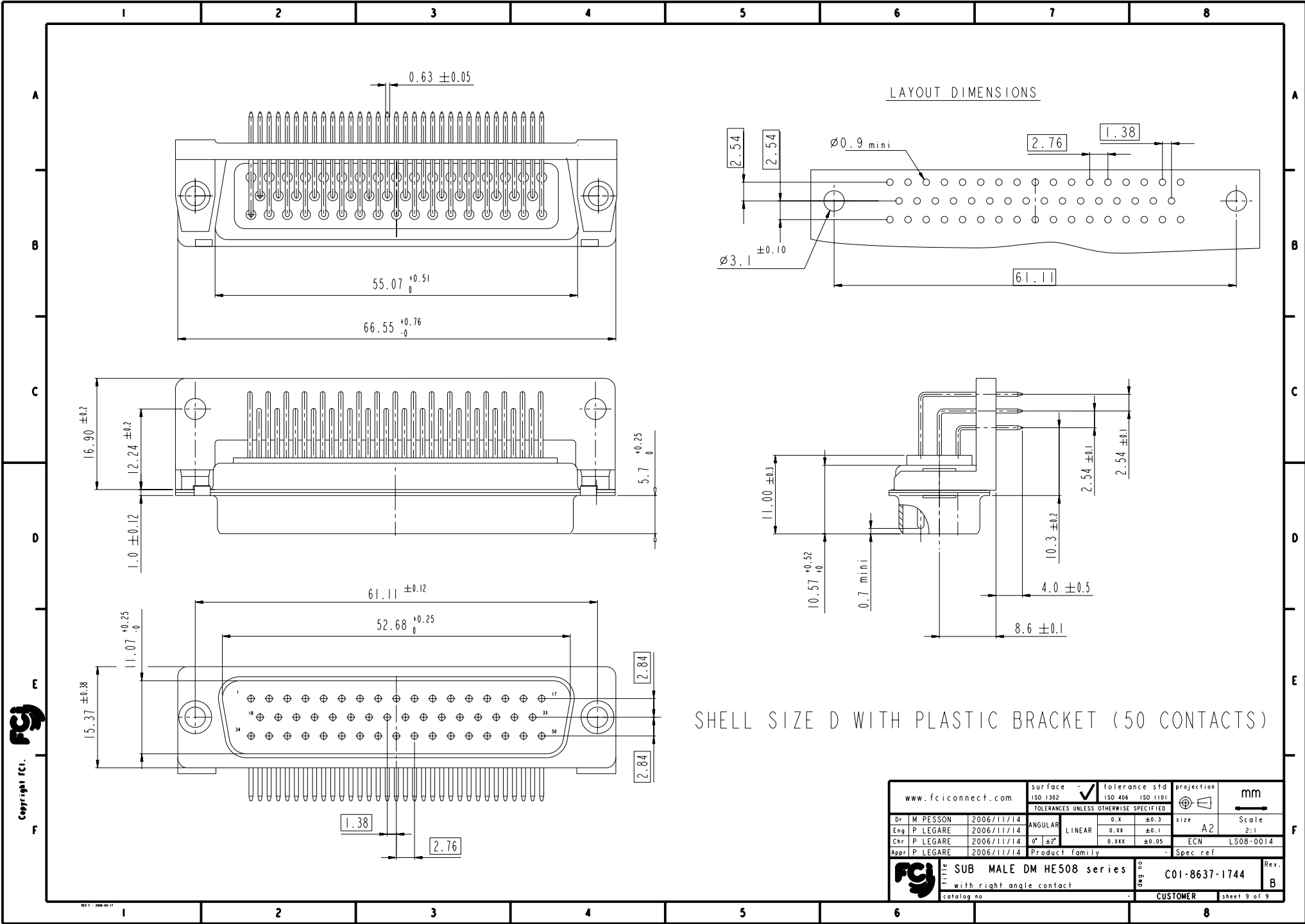

SHELL SIZE D WITH PLASTIC BRACKET (50 CONTACTS)

www.fciconnect.com		surface - ISO 1302	tolerance std ISO 406 ISO 1101	projection mm
		TOLERANCES UNLESS OTHERWISE SPECIFIED		
Dr M PESSON	2006/11/14	ANGULAR	0.X ±0.3	size A2 Scale 2:1
Eng P LEGARE	2006/11/14	LINEAR	0.XX ±0.1	ECN LS08-0014
Chr P LEGARE	2006/11/14	0° ±2°	0.XXX ±0.05	Product family - Spec ref
Appr P LEGARE	2006/11/14	Product family		Sub MALE DM HE508 series
Title		SUB MALE DM HE508 series		ang no C01-8637-1744
with right angle contact		catalog no		Rev. B
		CUSTOMER		sheet 9 of 9

Copyright fci. **FCI**