

MAXIM

Triple-Channel Video Reconstruction Filters with Back-Porch Clamp to GND

General Description

The MAX7438/MAX7439 three-channel standard definition video reconstruction filters include a back-porch clamp that sets the output blanking level of the video signal to ground. Each channel of the MAX7438/MAX7439 combines a lowpass filter with adjustable high-frequency boost levels and an output buffer capable of driving two standard 150Ω video loads. The blanking level of the output video signal on each channel is clamped to ground, eliminating the need for large AC-coupling output capacitors. Direct input coupling circuitry eliminates the need for AC-coupling input capacitors. This DC-in/DC-out architecture results in extremely low line-time distortion. The MAX7438/MAX7439 are ideal for antialiasing and DAC smoothing in digital video devices such as STBs, DVDs, PVRs, and hard disk recorders. The MAX7438/MAX7439 operate from ±5V dual supplies.

The three-channel MAX7438/MAX7439 are ideal for Y, P_b, P_r, and RGB component video signals, three composite video signals, and also Y/C plus CVBS video signals. Each filter channel achieves 60dB of attenuation at 27MHz and a maximally flat passband from DC to 5MHz.

The MAX7438 offers an internal gain of +2V/V, while the MAX7439 offers a gain of +3V/V.

Applications

Set-Top Boxes/HDR/DVD Game Consoles
Camcorders

Composite, Component, S-Video Output for NTSC, PAL, SDTV

Features

- ◆ Back-Porch of Video Output Signal Clamped to Ground
- ◆ Eliminates Input/Output AC-Coupling Capacitors
- ◆ 0.1% Line-Time Distortion
- ◆ Stopband: 55dB at 27MHz
- ◆ Passband: ±0.8dB out to 5MHz
- ◆ Diff Gain = 0.05%, Diff Phase = 0.05 Degrees
- ◆ Output Clamped to Ground with Loss of Input
- ◆ Each Output Drives Two 150Ω Video Loads
- ◆ Up to 2dB of High-Frequency Boost Control
- ◆ Ideal for CVBS, Y/C (S-Video), and RGB (Y, P_b, P_r) Outputs for NTSC, PAL, and SDTV
- ◆ Filter Bypass Mode
- ◆ Small 20-Pin 5mm × 5mm Thin QFN Package

Ordering Information

PART	TEMP RANGE	PIN-PACKAGE
MAX7438ETP	-40°C to +85°C	20 Thin QFN-EP*
MAX7439ETP	-40°C to +85°C	20 Thin QFN-EP*

*EP = Exposed paddle

Pin Configuration appears at end of data sheet.

Functional Diagram

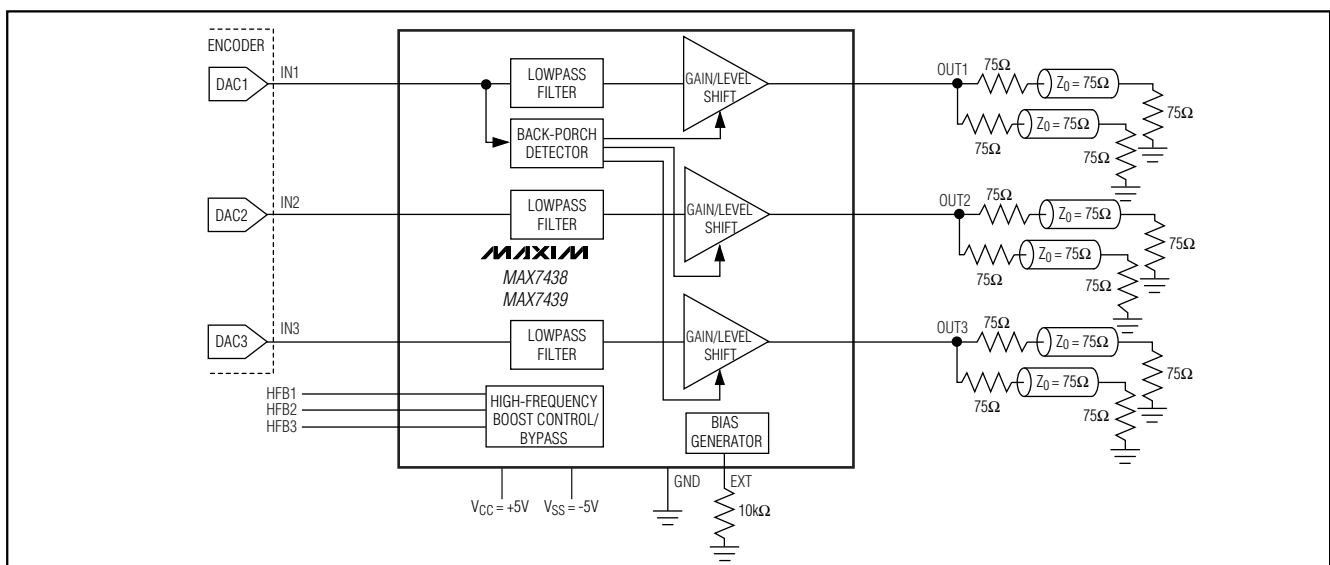
**MAXIM**

Maxim Integrated Products 1

For pricing, delivery, and ordering information, please contact Maxim/Dallas Direct! at 1-888-629-4642, or visit Maxim's website at www.maxim-ic.com.

MAX7438/MAX7439

Triple-Channel Video Reconstruction Filters with Back-Porch Clamp to GND

ABSOLUTE MAXIMUM RATINGS

V _{CC} to GND	-0.3V to +6V	Operating Temperature Range	-40°C to +85°C
V _{SS} to GND.....	-6V to +0.3V	Storage Temperature Range	-65°C to +150°C
OUT_ to GND	-2.5V to +3.5V	Junction Temperature	+150°C
All Other Pins to GND	(V _{SS} - 0.3V) to (V _{CC} + 0.3V)	Lead Temperature (soldering, 10s)	+300°C
Maximum Current into Any Pin	±50mA		
Continuous Power Dissipation (T _A = +70°C)			
20-Pin 5mm x 5mm Thin QFN (derate 20.8mW/°C			
above +70°C).....	1666.7mW		

Stresses beyond those listed under "Absolute Maximum Ratings" may cause permanent damage to the device. These are stress ratings only, and functional operation of the device at these or any other conditions beyond those indicated in the operational sections of the specifications is not implied. Exposure to absolute maximum rating conditions for extended periods may affect device reliability.

ELECTRICAL CHARACTERISTICS

(V_{CC} = +5V ±5%, V_{SS} = -5V ±5%, R_{EXT} = 10kΩ ±1%, R_{HFB,-1} = 15kΩ ±1%, R_{HFB,-2} = 1kΩ ±1%, no boost, R_{OUT} = 75Ω, C_{OUT} = 0 to 20pF, T_A = T_{MIN} to T_{MAX}, unless otherwise noted. Typical values are at T_A = +25°C.)

PARAMETER	SYMBOL	CONDITIONS		MIN	TYP	MAX	UNITS
Passband Response		f = 100kHz to 4.2MHz, no HF boost		-0.6		+0.6	dB
		f = 100kHz to 5MHz, no HF boost		-0.8		+0.8	
Stopband Attenuation	A _{SB}	f = 27MHz, relative to 100kHz		40	60		dB
HF Boost Step Size		f = 4.2MHz			0.45		dB
HFB_ Voltage Range	V _{HFB_}	Bypass		0		50	mV
		No boost		280		360	
		Boost 1		670		850	
		Boost 2		1360		1700	
		Boost 3		2250		2750	
		Boost 4		3500		V _{CC}	
Differential Gain	dG	5-step modulated staircase	MAX7438, V _{IN} = 1V _{P-P}		0.05	0.5	%
			MAX7439, V _{IN} = 670mV _{P-P}		0.05	0.5	
Differential Phase	dθ	5-step modulated staircase	MAX7438, V _{IN} = 1V _{P-P}		0.05	0.5	Degrees
			MAX7439, V _{IN} = 670mV _{P-P}		0.05	0.5	
Total Harmonic Distortion	THD	f = 100kHz to 5MHz, V _{IN} = 0.7V _{P-P}	MAX7438, V _{IN} = 700mV _{P-P}		0.2	0.5	%
			MAX7439, V _{IN} = 460mV _{P-P}		0.2	0.5	
Signal-to-Noise Ratio	SNR	Output signal (2V _{P-P}) to P-P noise, f = 100Hz to 5MHz		68	75		dB
Group Delay Deviation	Δt _G	Deviation from 100kHz to 3.58(4.43)MHz			12	30	ns
Group Delay Matching	t _{G(MATCH)}	f = 100kHz			2		ns
Line-Time Distortion	H _{DIST}	18μs, 100 IRE bar			0.1		%
Field-Time Distortion	V _{DIST}	130 lines, 18μs, 100 IRE bar			0.2		%

Triple-Channel Video Reconstruction Filters with Back-Porch Clamp to GND

ELECTRICAL CHARACTERISTICS (continued)

($V_{CC} = +5V \pm 5\%$, $V_{SS} = -5V \pm 5\%$, $R_{EXT} = 10k\Omega \pm 1\%$, $R_{HFB_1} = 15k\Omega \pm 1\%$, $R_{HFB_2} = 1k\Omega \pm 1\%$, no boost, $R_{OUT} = 75\Omega$, $C_{OUT} = 0$ to $20pF$, $T_A = T_{MIN}$ to T_{MAX} , unless otherwise noted. Typical values are at $T_A = +25^\circ C$.)

PARAMETER	SYMBOL	CONDITIONS	MIN	TYP	MAX	UNITS	
Clamp Accuracy		Output blanking level relative to GND	-55		+55	mV	
Clamp Settling Time		Back porch within the specified clamp accuracy			50	Lines	
Low-Frequency Gain		Gain at 100kHz	MAX7438	5.5	6	6.5	dB
			MAX7439	9	9.54	10	
Low-Frequency Gain Matching	t_G	Channel-to-channel gain matching, $f = 100kHz$			+5	%	
Input Voltage Range		THD < 0.5%	-0.5		+1.8	V	
Output Voltage Range	V_{OUT}	$f = 5MHz$	-0.8		+1.8	V	
Channel-to-Channel Crosstalk	X_{TALK}	Channel-to-channel crosstalk, $f = 5MHz$		-60		dB	
Output Short-Circuit Current	I_{SC}	OUT_ shorted to GND or V_{CC}		50		mA	
Input Leakage Current at IN_	$I_{IN_}$			± 1	± 5	μA	
Input Leakage Current at HFB_	$I_{HFB_}$	Bypass mode, boost 1 to boost 3			0.2	μA	
		Boost 4			30		
Input Resistance			500			k Ω	
Supply Voltage Range	V_{CC}		4.75		5.25	V	
	V_{SS}		-4.75		-5.25		
Supply Current	I_{CC}	$V_{CC} = +5.25V$, no load		110	160	mA	
	I_{SS}	$V_{SS} = -5.25V$, no load		110	160		
Power-Supply Rejection Ratio	PSRR	$V_{IN} = 100mV_{P-P}$, $f = 0$ to $3.5MHz$		30		dB	

Typical Operating Characteristics

($V_{CC} = +5V$, $V_{SS} = -5V$, $R_{OUT_} = 150\Omega$, $R_{EXT} = 10k\Omega$, no boost, $T_A = +25^\circ C$, unless otherwise noted.)

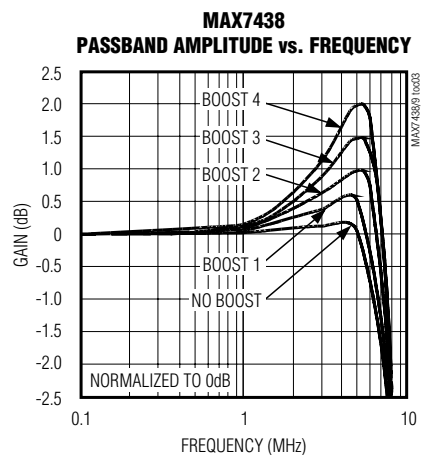
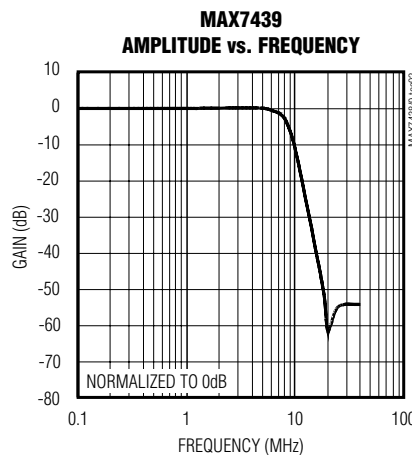
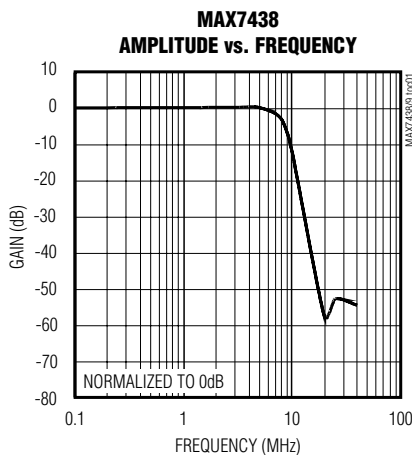

Triple-Channel Video Reconstruction Filters with Back-Porch Clamp to GND

Typical Operating Characteristics (continued)

($V_{CC} = +5V$, $V_{SS} = -5V$, $R_{OUT_} = 150\Omega$, $R_{EXT} = 10k\Omega$, no boost, $T_A = +25^\circ C$, unless otherwise noted.)

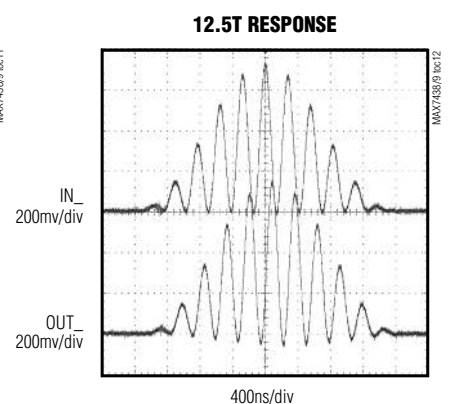
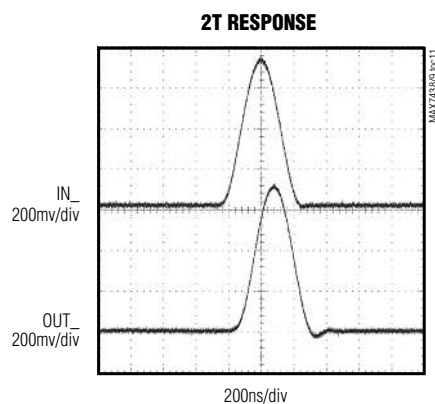
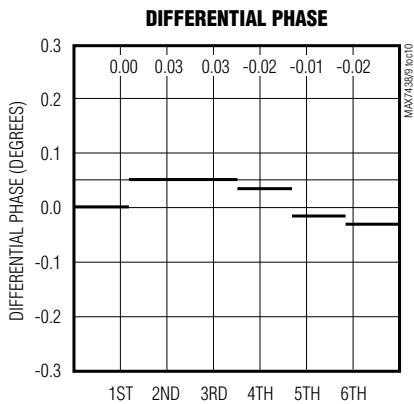
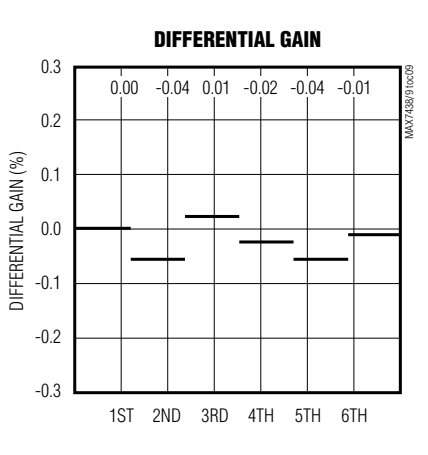
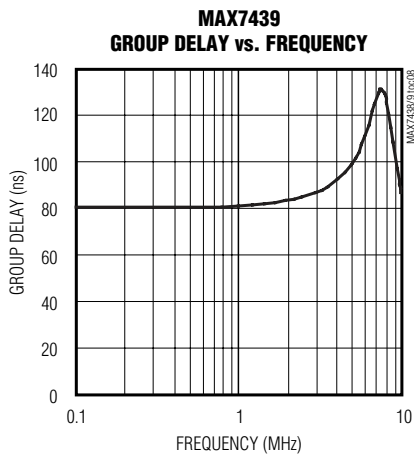
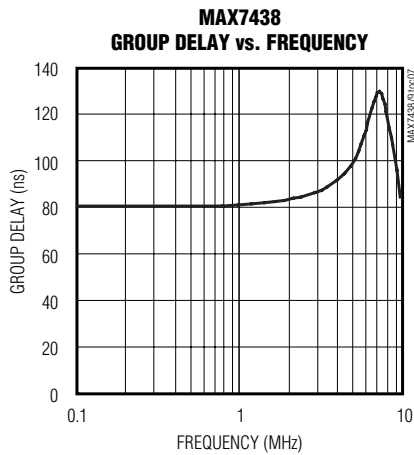
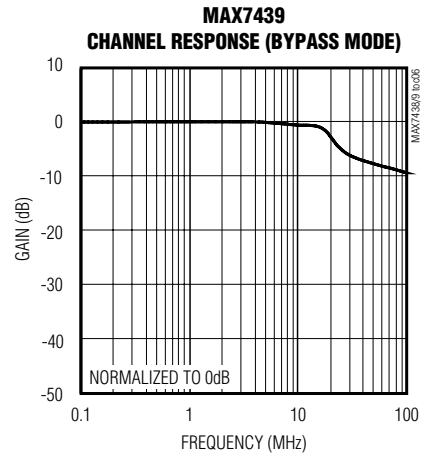
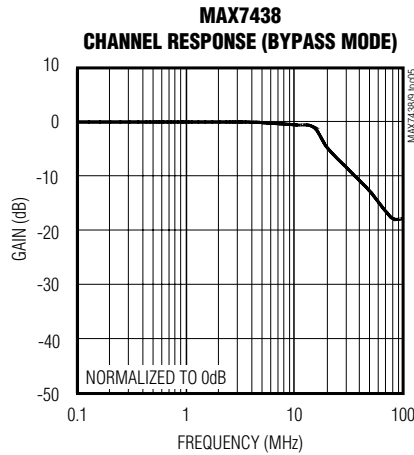
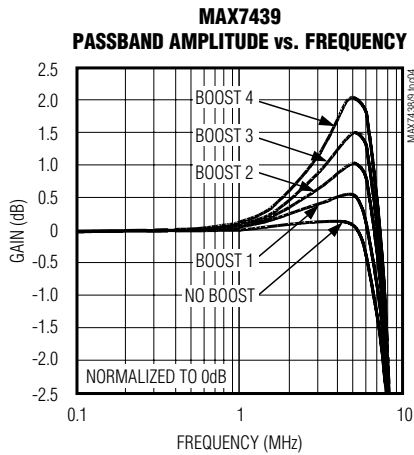

Triple-Channel Video Reconstruction Filters with Back-Porch Clamp to GND

Typical Operating Characteristics (continued)

($V_{CC} = +5V$, $V_{SS} = -5V$, $R_{OUT_} = 150\Omega$, $R_{EXT} = 10k\Omega$, no boost, $T_A = +25^\circ C$, unless otherwise noted.)

MAX7438/MAX7439

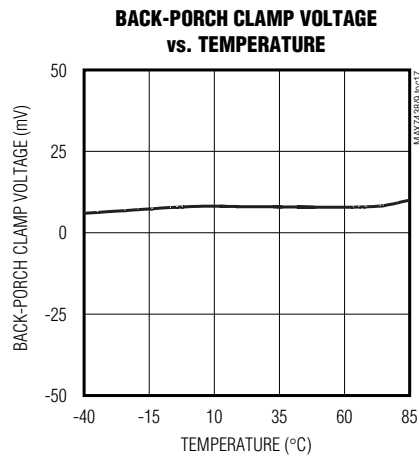
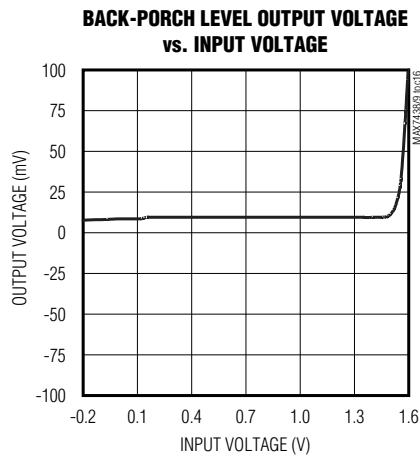
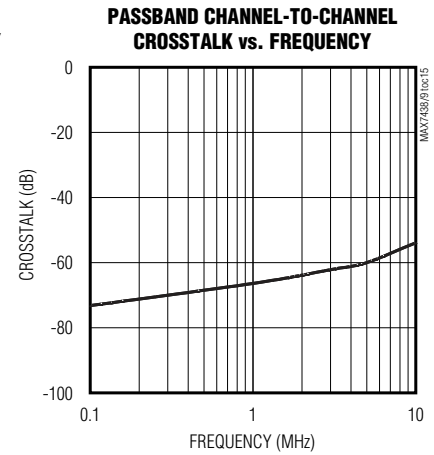
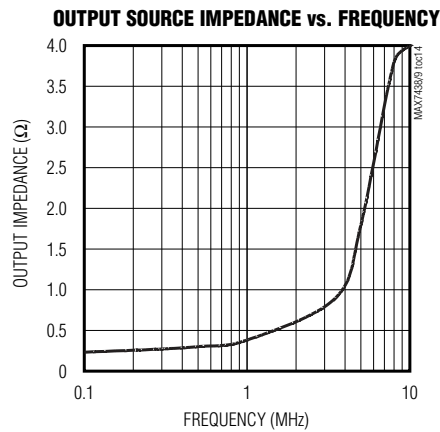
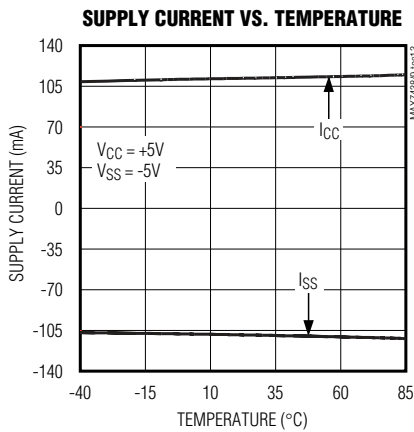

Triple-Channel Video Reconstruction Filters with Back-Porch Clamp to GND

Pin Description

PIN	NAME	FUNCTION
1, 4, 7, 10, 11, 13, 15, 19	GND	Ground
2	IN1	Channel 1 Video Input
3	HFB1	Channel 1 High-Frequency Boost and Filter Bypass Control Input. Connect external resistors to HFB1 for high-frequency boost and filter bypass control. See Table 1.
5	OUT1	Channel 1 Video Output
6	VCC	+5V Power Input
8	OUT2	Channel 2 Video Output
9	VSS	-5V Power Input. Connect the backside exposed pad to VSS.
12	OUT3	Channel 3 Video Output
14	HFB3	Channel 3 High-Frequency Boost and Filter Bypass Control Input. Connect external resistors to HFB3 for high-frequency boost and filter bypass control. See Table 1.
16	IN3	Channel 3 Video Input
17	HFB2	Channel 2 High-Frequency Boost and Filter Bypass Control Input. Connect external resistors to HFB2 for high-frequency boost and filter bypass control. See Table 1.
18	IN2	Channel 2 Video Input
20	EXT	External Bias Resistor. Connect a 10kΩ resistor from EXT to GND.
—	EP	Exposed Paddle. Connect to VSS. Do not connect to GND.

Table 1. External Resistor Values for Bypass Mode and High-Frequency Boost Control

MODE	R _{HFB_-1} (kΩ)	R _{HFB_-2} (kΩ)	V _{HFB_} (V) (V _{CC} = 5V)	NOMINAL BOOST (dB)/ BYPASS (MAX7438)	NOMINAL BOOST (dB)/ BYPASS (MAX7439)
Bypass	Open	0	0	Bypass	Bypass
No boost	15	1	0.318	0	0
Boost 1	11.3	2	0.758	0.5	0.75
Boost 2	16.5	7.32	1.53	1.0	1.5
Boost 3	11.3	11.3	2.5	1.5	2.25
Boost 4	4.42	18.2	4.027	2.0	3.0

Detailed Description

Filter

Filter Response

The MAX7438/MAX7439 reconstruction filters consist of three separate lowpass filters with Butterworth-type response. The filter features a maximally flat passband for NTSC and PAL bandwidths, while maintaining good group delay characteristics. The stopband offers excellent attenuation at frequencies of 27MHz and above (see the *Typical Operating Characteristics* section).

The autotrimming circuit digitally controls the corner frequency to maintain the frequency characteristics over process and temperature.

High-Frequency Boost

The high-frequency boost compensates for signal degradation and roll-off in the signal path prior to the MAX7438/MAX7439 to increase image sharpness. Program the level of high-frequency boost for each channel by selecting the corresponding external resistor values (R_{HFB_-1} and R_{HFB_-2}, as shown in the *Typical Operating Circuit* section) given in Table 1. The

Triple-Channel Video Reconstruction Filters with Back-Porch Clamp to GND

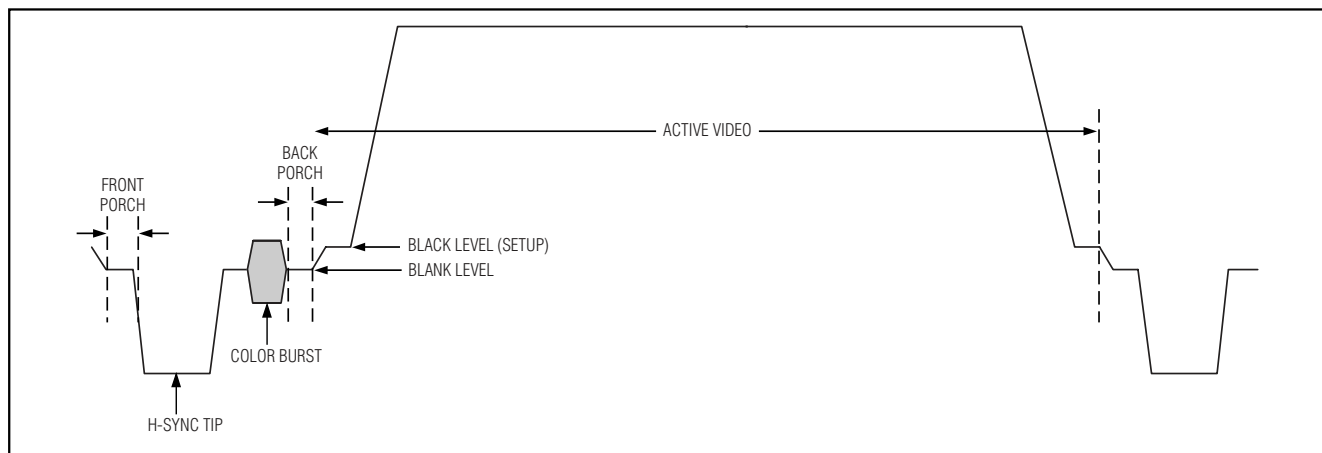

Figure 1. Standard Video Signal

external resistors form a voltage-divider between V_{CC} and GND. The values in the fourth column ($V_{HFB_}$ (V)) are calculated using the following equation:

$$V_{HFB_} = V_{CC} \times R_{HFB_2} / (R_{HFB_1} + R_{HFB_2})$$

where $V_{CC} = 5V$.

Apply an external voltage to $HFB_$ in place of R_{HFB_1} and R_{HFB_2} as an alternative. See the *Electrical Characteristics* section. Filter boost modes can also be controlled from a microprocessor. See the *Applications Information* section.

Filter Bypass

The MAX7438/MAX7439 offer selectable filter bypassing that allows any of the video inputs to be filtered or unfiltered. Select the filter bypass mode for a given channel by setting the corresponding values for R_{HFB_1} and R_{HFB_2} according to Table 1.

Output Buffer

The output buffer is able to drive two standard 150Ω video loads with a $2V_{p-p}$ signal. The MAX7438 output buffer has a preset gain of $2V/V$, and the MAX7439 output buffer has a gain of $3V/V$. The MAX7439 is ideal for a DAC output whose voltage range is between $0.67V$ and $1V$. Set the DAC output to $0.67V$ to achieve a $2V/V$ signal on $OUT_$.

Back-Porch Clamp

The MAX7438/MAX7439 feature a back-porch clamp to set the output blanking level. This clamp shifts the DC level of the video signal so that the back-porch level is close to ground (see Figure 1). The devices sense the voltage during back porch and feed back into a control

system that provides the appropriate DC-level shift in the filter channel to clamp the output to ground. The back-porch clamp to ground eliminates the need for large output-coupling capacitors that can introduce unwanted line-time distortion (tilt), cost, and board space. This feedback network and the on-chip capacitors introduce a finite settling time (50 lines max) after power-up or any dramatic shift in input voltage (see the *Electrical Characteristics* section).

Channel 1 requires a video signal with sync information (CVBS, Y, or G), since the other two channels are clamped from channel 1. In the absence of a sync on channel 1, the circuit forces all outputs actively and continuously to ground.

Applications Information

Power-Supply Bypassing and Layout

The MAX7438/MAX7439 operate from dual $\pm 5V$ supplies. Bypass V_{CC} and V_{SS} to GND with $0.1\mu F$ capacitors in parallel with $1\mu F$ capacitors. Place the $0.1\mu F$ capacitors as close to the power inputs as possible. Since EXT is a sensitive input, place R_{EXT} close to the device to avoid signals coupling into EXT. Do not route any input, output, or dynamic signal near this pin and the accompanying trace.

Note: The exposed paddle is electrically connected to VSS.

Do not connect the exposed paddle to ground. Refer to the MAX7438 EV kit for layout examples, as well as a proven PC board layout example.

Triple-Channel Video Reconstruction Filters with Back-Porch Clamp to GND

Typical Operating Circuit

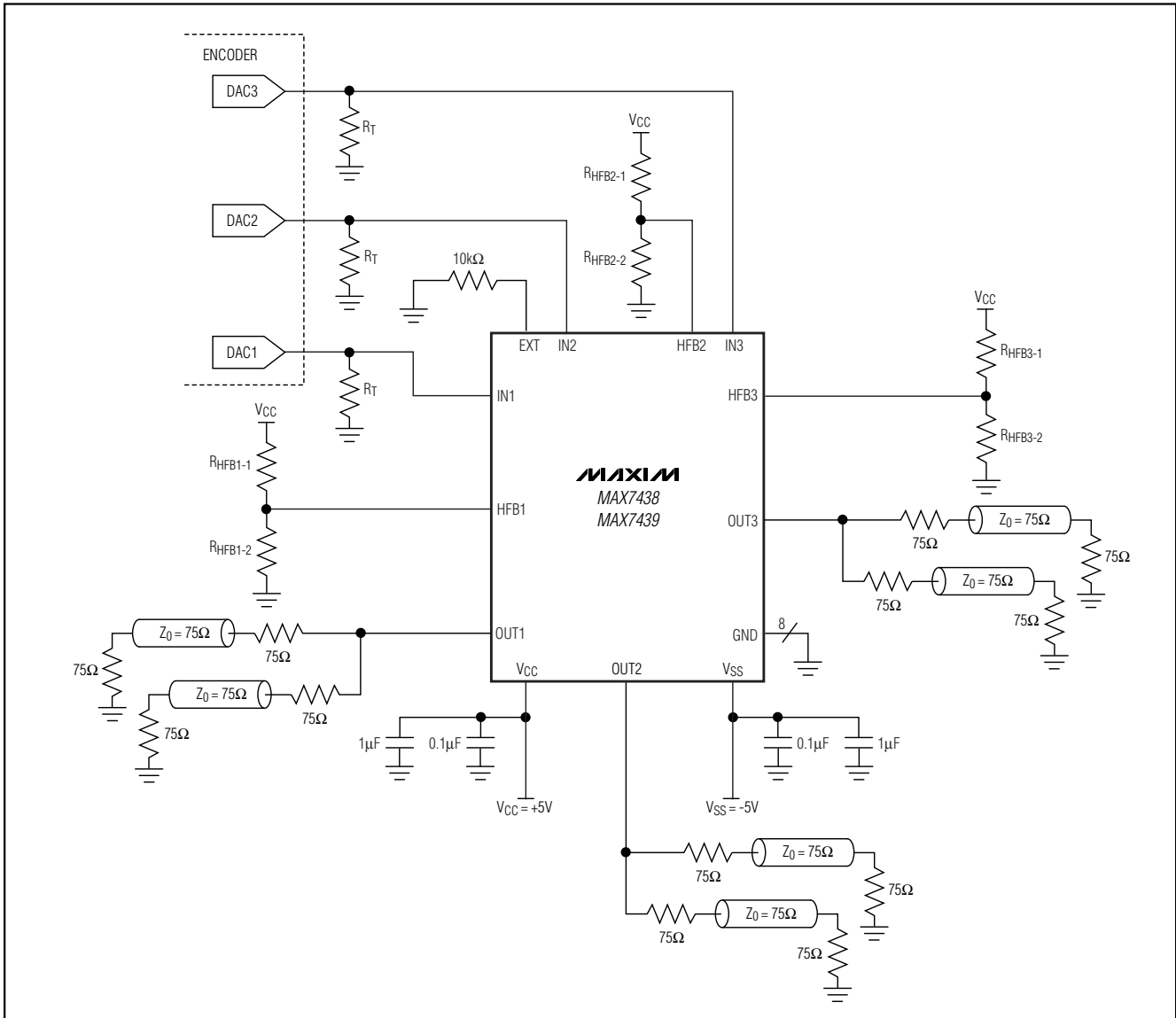

Microprocessor Control of High-Frequency Boost and Bypass

Use a DAC output to control the bypass and high-frequency boost levels on each channel (see Figure 2). Set the DAC output voltage to the corresponding bypass or boost levels desired (see Table 1).

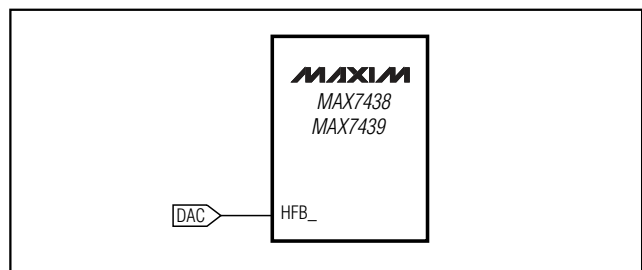
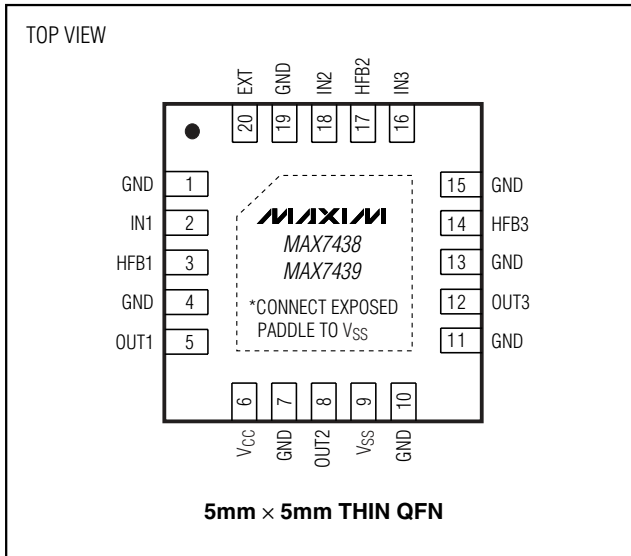

Figure 2. DAC Control of High-Frequency Boost and Bypass

Triple-Channel Video Reconstruction Filters with Back-Porch Clamp to GND

Pin Configuration



Chip Information

TRANSISTOR COUNT: 6418

PROCESS: BICMOS

MAX7438/MAX7439

Triple-Channel Video Reconstruction Filters with Back-Porch Clamp to GND

Package Information

(The package drawing(s) in this data sheet may not reflect the most current specifications. For the latest package outline information, go to www.maxim-ic.com/packages.)

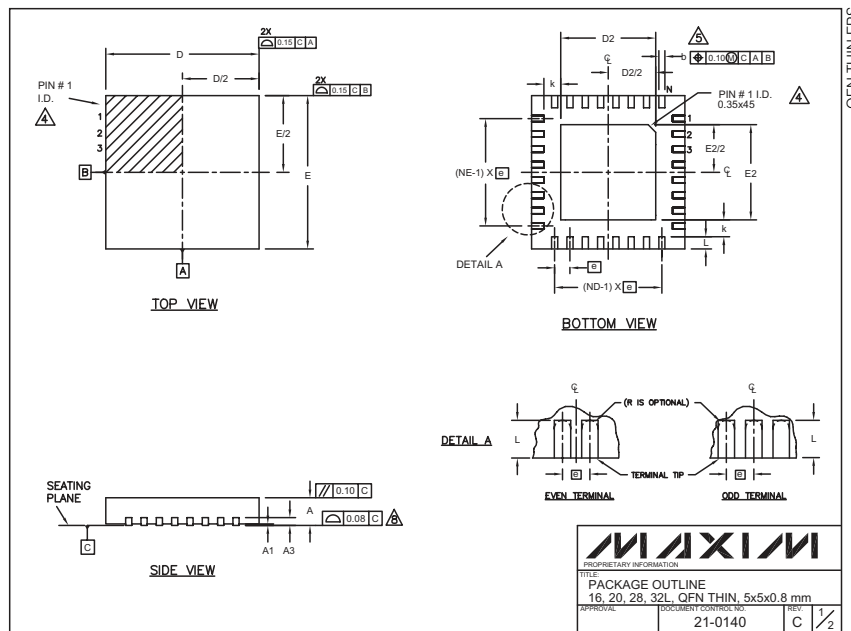

PKG. SYMBOL	COMMON DIMENSIONS												EXPOSED PAD VARIATIONS					
	16L 5x5			20L 5x5			28L 5x5			32L 5x5			D2			E2		
A	0.70	0.75	0.80	0.70	0.75	0.80	0.70	0.75	0.80	0.70	0.75	0.80	3.00	3.10	3.20	3.00	3.10	3.20
A1	0	0.02	0.05	0	0.02	0.05	0	0.02	0.05	0	0.02	0.05	3.00	3.10	3.20	3.00	3.10	3.20
A3	0.20 REF.			0.20 REF.			0.20 REF.			0.20 REF.			3.15	3.25	3.35	3.15	3.25	3.35
b	0.25	0.30	0.35	0.25	0.30	0.35	0.20	0.25	0.30	0.20	0.25	0.30	2.60	2.70	2.80	2.60	2.70	2.80
D	4.90	5.00	5.10	4.90	5.00	5.10	4.90	5.00	5.10	4.90	5.00	5.10	3.00	3.10	3.20	3.00	3.10	3.20
E	4.90	5.00	5.10	4.90	5.00	5.10	4.90	5.00	5.10	4.90	5.00	5.10						
e	0.80 BSC.			0.85 BSC.			0.50 BSC.			0.50 BSC.								
k	0.25	-	-	0.25	-	-	0.25	-	-	0.25	-	-						
L	0.45	0.55	0.65	0.45	0.55	0.65	0.45	0.55	0.65	0.30	0.40	0.50						
N	16			20			28			32								
ND	4			5			7			8								
NE	4			5			7			8								
JEDEC	WHHB			WHHC			WHHD-1			WHHD-2								

NOTES:

- DIMENSIONING & TOLERANCING CONFORM TO ASME Y14.5M-1994.
- ALL DIMENSIONS ARE IN MILLIMETERS, ANGLES ARE IN DEGREES.
- N IS THE TOTAL NUMBER OF TERMINALS.
- THE TERMINAL #1 IDENTIFIER AND TERMINAL NUMBERING CONVENTION SHALL CONFORM TO JEDEC 95-1 SPP-012. DETAILS OF TERMINAL #1 IDENTIFIER ARE OPTIONAL, BUT MUST BE LOCATED WITHIN THE ZONE INDICATED. THE TERMINAL #1 IDENTIFIER MAY BE EITHER A MOLD OR MARKED FEATURE.
- DIMENSION b APPLIES TO METALLIZED TERMINAL AND IS MEASURED BETWEEN 0.25 mm AND 0.30 mm FROM TERMINAL TIP.
- ND AND NE REFER TO THE NUMBER OF TERMINALS ON EACH D AND E SIDE RESPECTIVELY.
- DEPOPULATION IS POSSIBLE IN A SYMMETRICAL FASHION.
- COPLANARITY APPLIES TO THE EXPOSED HEAT SINK SLUG AS WELL AS THE TERMINALS.
- DRAWING CONFORMS TO JEDEC MO220.
- WARPAGE SHALL NOT EXCEED 0.10 mm.

PROPRIETARY INFORMATION
 TITLE PACKAGE OUTLINE
 16, 20, 28, 32L, QFN THIN, 5x5x0.8 mm
 APPROVAL _____ DOCUMENT CONTROL NO. 21-0140 REF: C 2/2

Maxim cannot assume responsibility for use of any circuitry other than circuitry entirely embodied in a Maxim product. No circuit patent licenses are implied. Maxim reserves the right to change the circuitry and specifications without notice at any time.

10 **Maxim Integrated Products, 120 San Gabriel Drive, Sunnyvale, CA 94086 408-737-7600**